

10. ESTROGENS IN ENDOCRINE AND NEUROENDOCRINE SYSTEM

THE HIERARCHICAL NATURE OF HORMONE ACTION

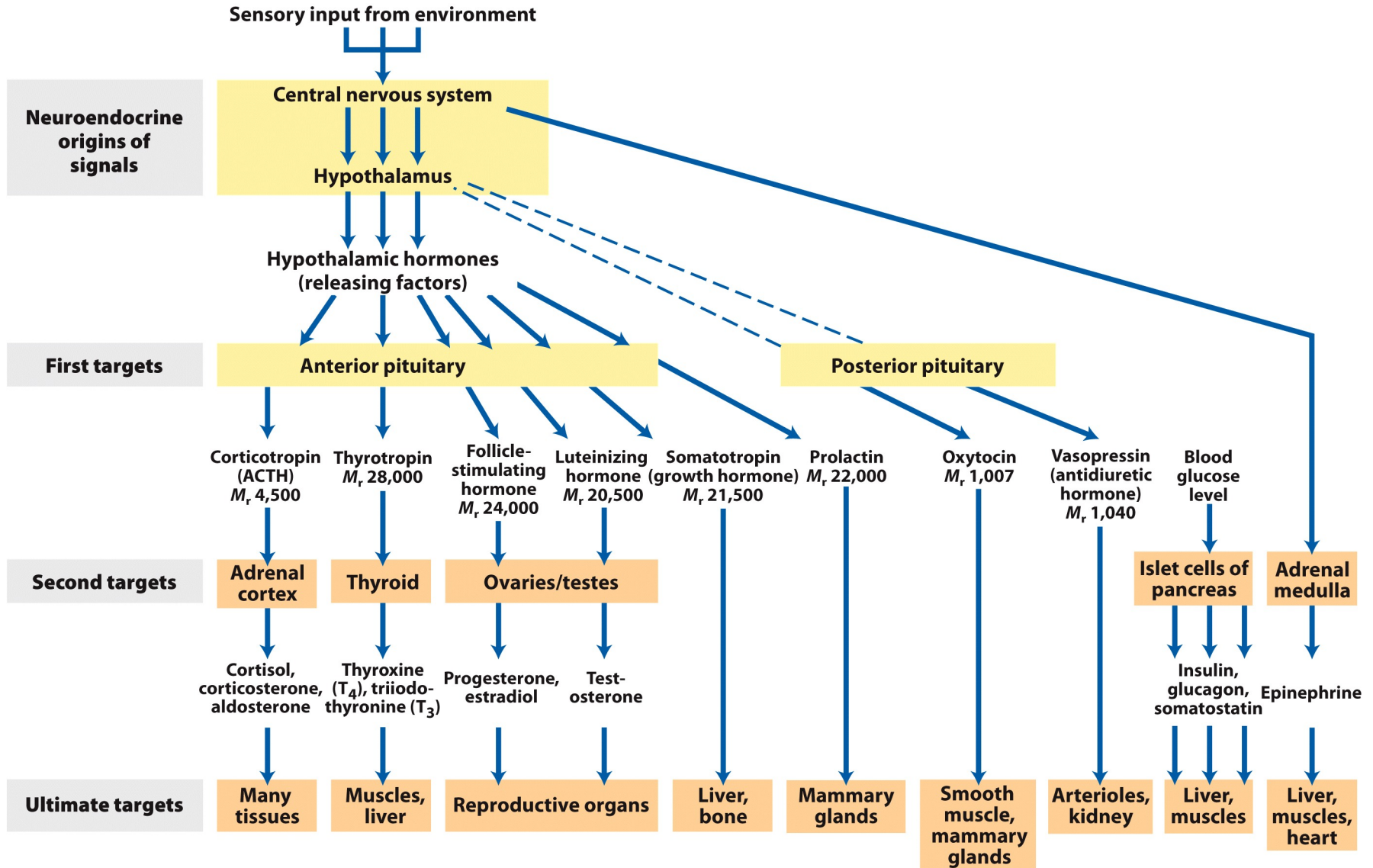
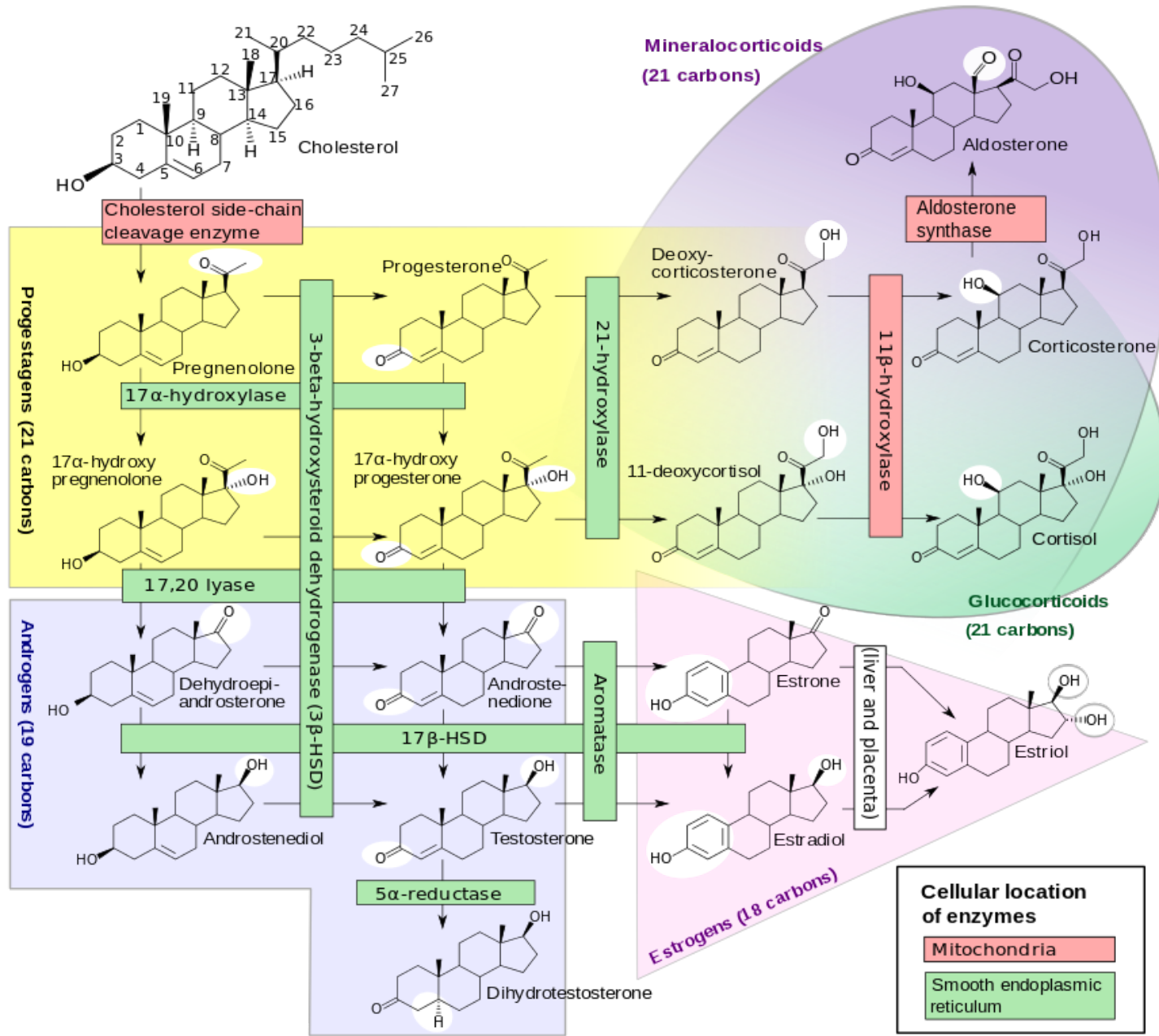
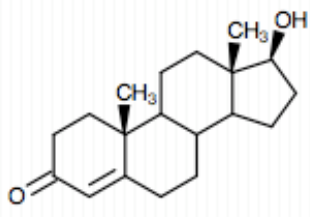

Figure 23-7
 Lehninger Principles of Biochemistry, Sixth Edition
 © 2013 W. H. Freeman and Company

STEROID HORMONE SYNTHESIS



HUMAN AROMATASE (CYP19A1)



Testosterone

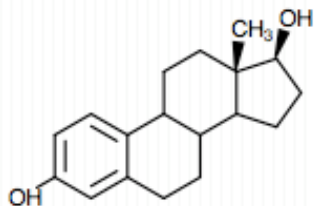
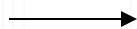

Estradiol

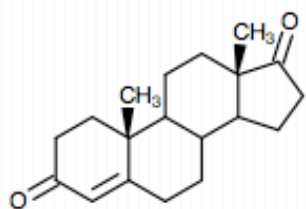

Androstenedione

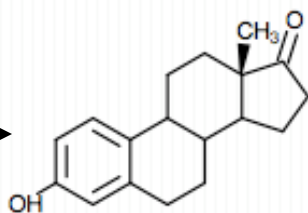

Estrone

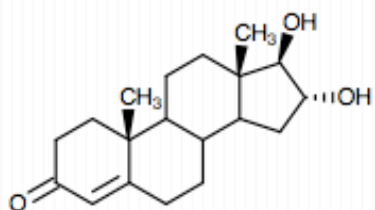

16- α -hydroxytestosterone

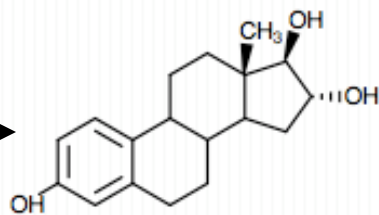
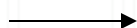

Estriol

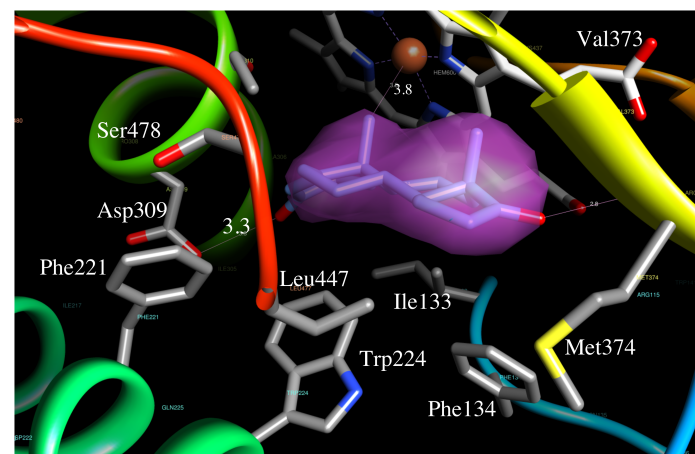

HUMAN AROMATASE (CYP19A1)

- Electrons derive from NADPH through the redox partner cytochrome P450 reductase

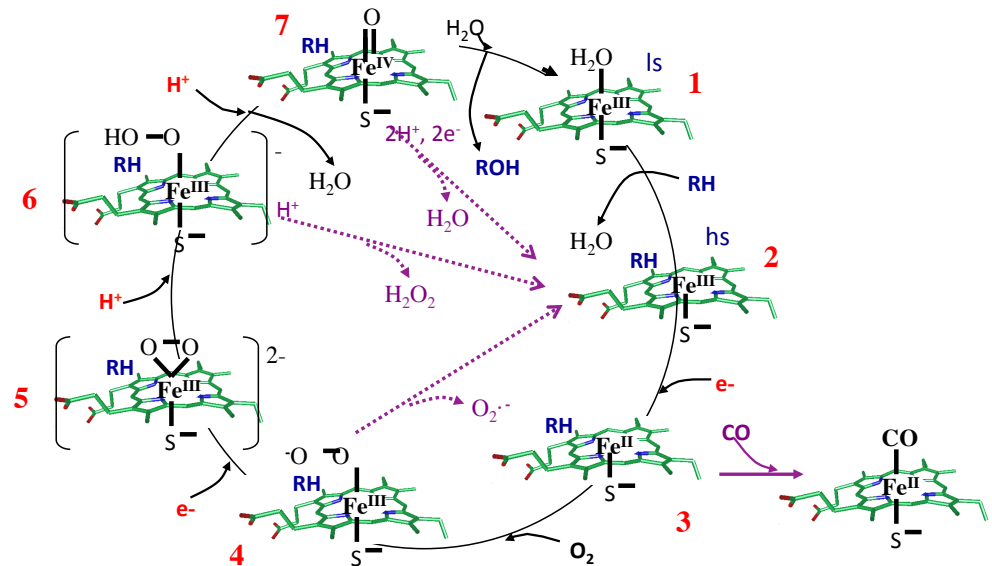
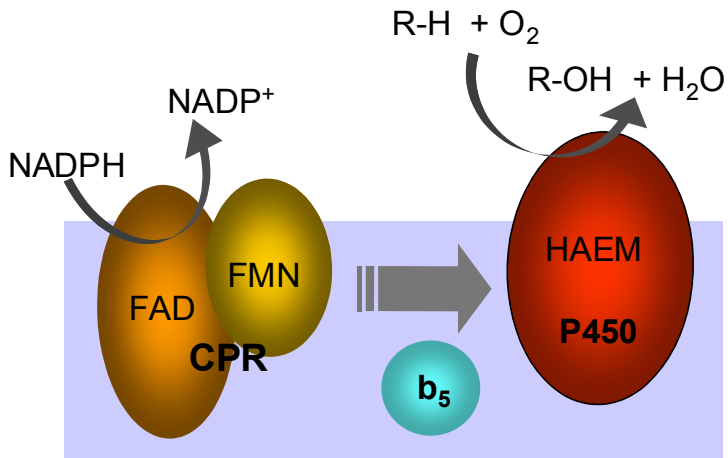

HUMAN AROMATASE (CYP19A1)

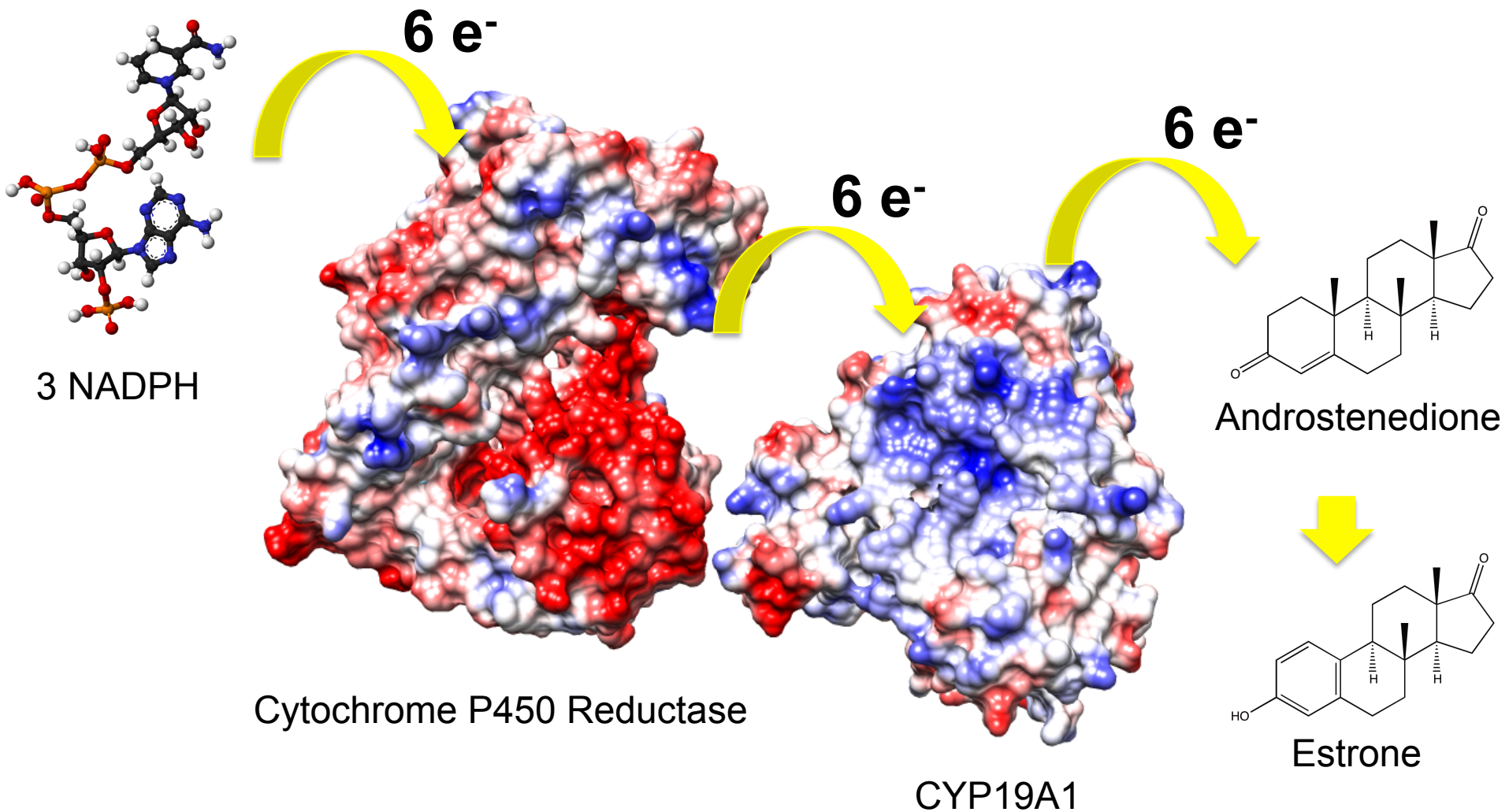

AROMATASE DISTRIBUTION IN ANIMALS



CYP19 appears in

- an early-diverging chordate, the cephalochordate amphioxus (the Florida lancelet, *Branchiostoma floridae*)

- does not appear to be present in nonchordate invertebrates (e.g. insects, molluscs, echinoderms, sponges, corals).

- 1 isoform in:

- amphibians
- reptiles
- birds
- most mammals

- 2 isoforms (CYP19A and CYP19B) arising from gene duplication events in:

- Fish (Teleosts) ovarian and brain

- 3 isoforms in:

- Pig (type I - ovary, type II - placenta, and type III embryo)

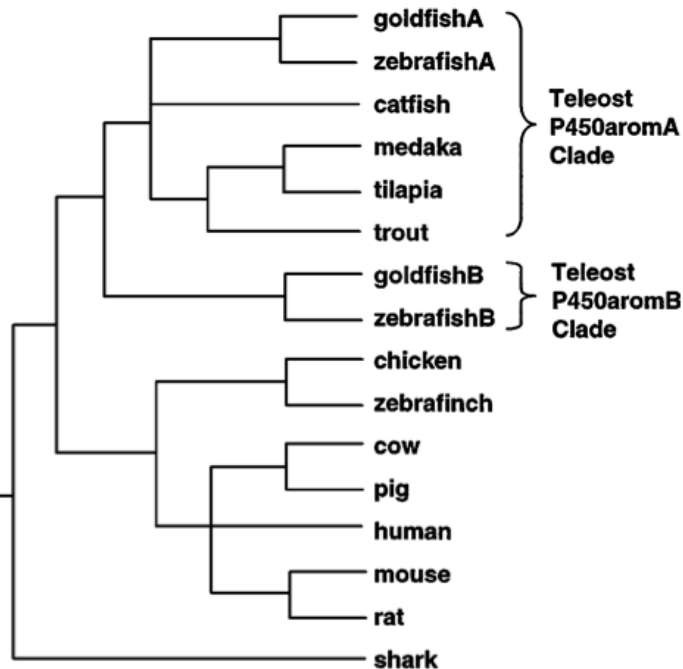

AROMATASE EXPRESSION IN HUMAN BODY

- Physiologically expressed by ovaries, placenta, adipose tissue, brain, muscle and skin fibroblasts.
- Tissue-specific expression by alternative use of multiple promoters.
- Over-expressed in breast, uterine, testicular and adrenal tumours.

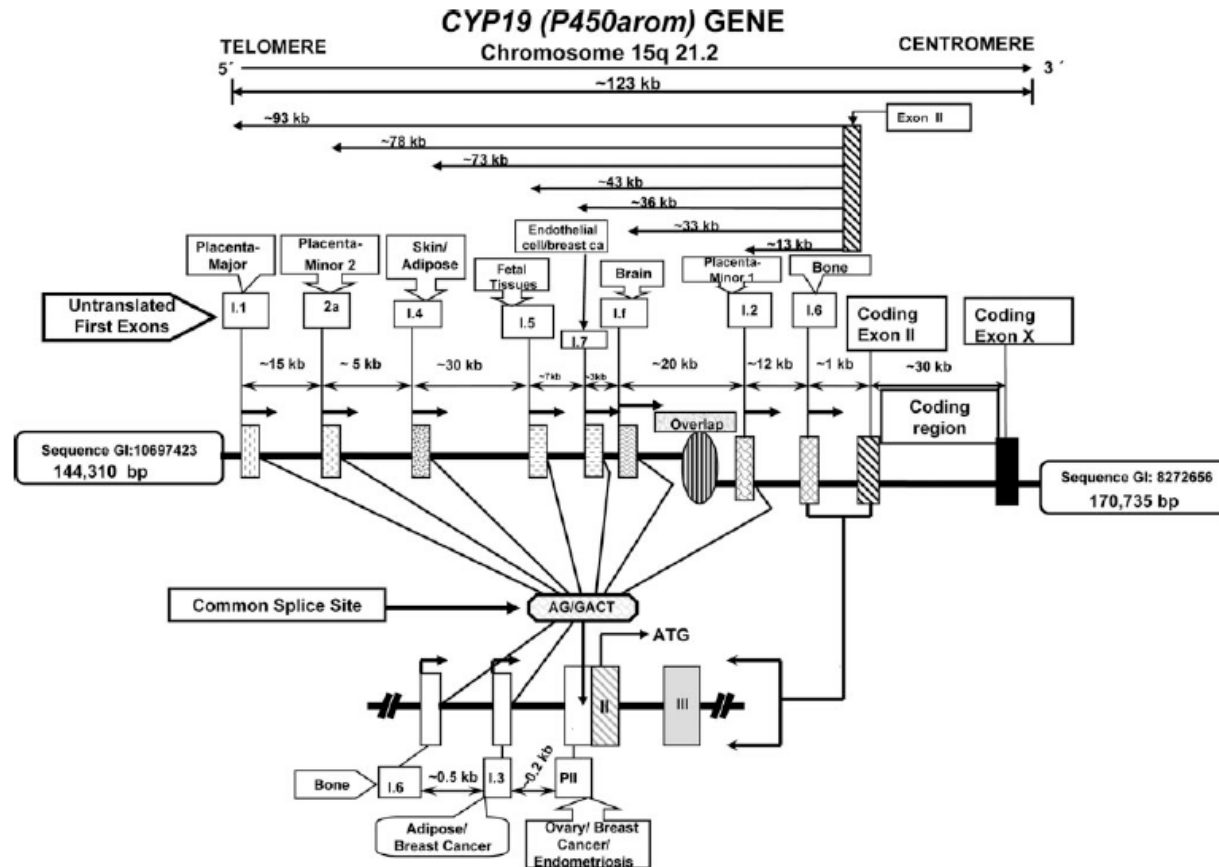
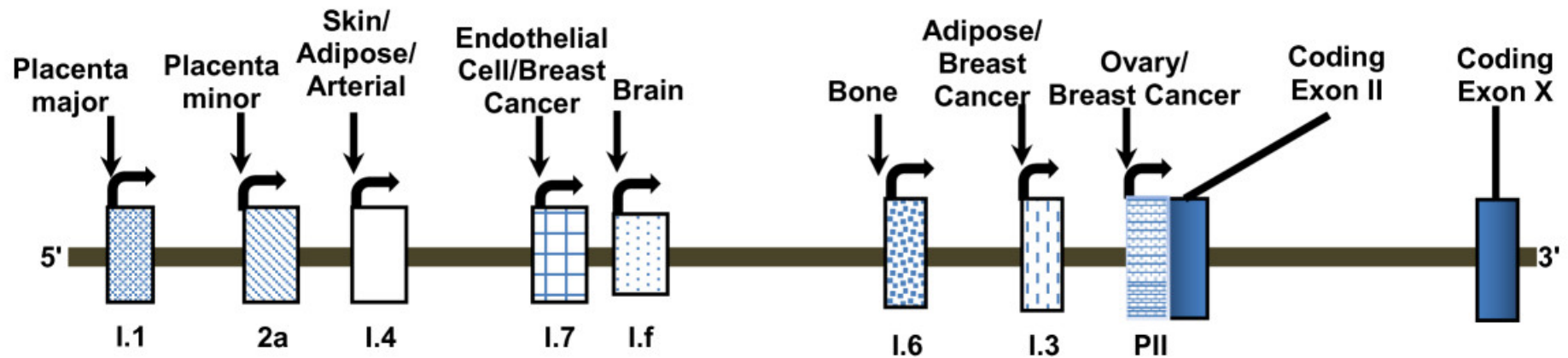

FIG 7. Diagrammatic representation of the aromatase gene, the alternate exons I, and its location on chromosome 15. A different nomenclature for the alternative exons evolved during contemporaneous studies in the laboratories of Evan Simpson and Nobohiro Harada. The Simpson nomenclature is that shown in Fig. 3. In the case of the Harada nomenclature, the placental promoter (I.1 above) is designated 1a; the adipose/ bone promoter (I.4 above) is 1b; I.3 above is 1c, and II above is 1d. It was realized that bone employed a promoter that was identical to that found in adipose tissue (264) (I.4/1b), whereas in brain another unique promoter was described by Harada's group and is named promoter 1f (361). [Reproduced from S. E. Bulun *et al.*: *Journal of Steroid Biochemistry and Molecular Biology* 86:219–224, 2003, with permission from Elsevier.]

AROMATASE EXPRESSION IN HUMAN BODY

- Human aromatase gene is located on chromosome 15 and transcribes from telomere towards centromere.
- The aromatase gene is ~ 123 kb long contains nine coding exons (II-X).
- Partially tissue specific promoters direct aromatase gene transcription.



- Extragonadal sites of estrogen biosynthesis possess several fundamental features that differ from those of the ovaries.

AROMATASE IN OVARY

- Function: ovaries produce ova (eggs; singular ovum) in regular cycle determined by hormonal secretions.
- Functions of ovarian hormones and their secretions are tied to secretion of FSH and LH from anterior pituitary gland.

ESTROGENS – stimulate development of female sex organs and sexual characteristics.

PROGESTERONE + ESTROGENS – regulate menstrual cycle; maintain pregnancy in presence of developing embryo or fetus.

AROMATASE IN BONE TISSUE

- Estrogens effects in bone in females have been well established as estrogen deficiency after menopause leads to an imbalance between bone resorption by osteoclasts and bone formation by osteoblasts

- In bone, aromatase is expressed primarily in osteoblasts and chondrocytes
- Plasma estradiol levels correlate better with bone mineral density than do testosterone levels in aging men
- Major role for estrogens on maintenance of bone mass also in men has been demonstrated

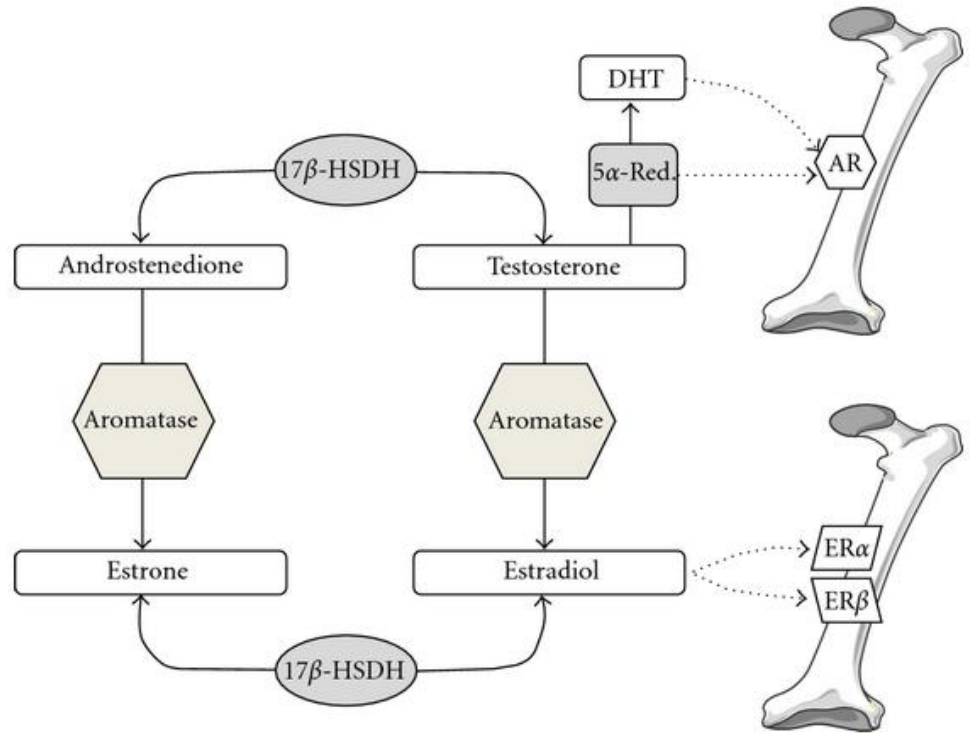

- Aromatase activity and estrogen production are necessary for longitudinal bone growth, the attainment of peak bone mass, pubertal growth spurt, epiphyseal closure, and normal bone remodeling in young individuals.
- Moreover, with aging, individual differences in aromatase activity may significantly affect bone loss and fracture risk in men.

AROMATASE IN SKELETAL MUSCLE

Skeletal muscle is capable of synthesizing and metabolizing testosterone and estradiol from dehydroepiandrosterone (DHEA), and dihydrotestosterone (DHT) from testosterone.

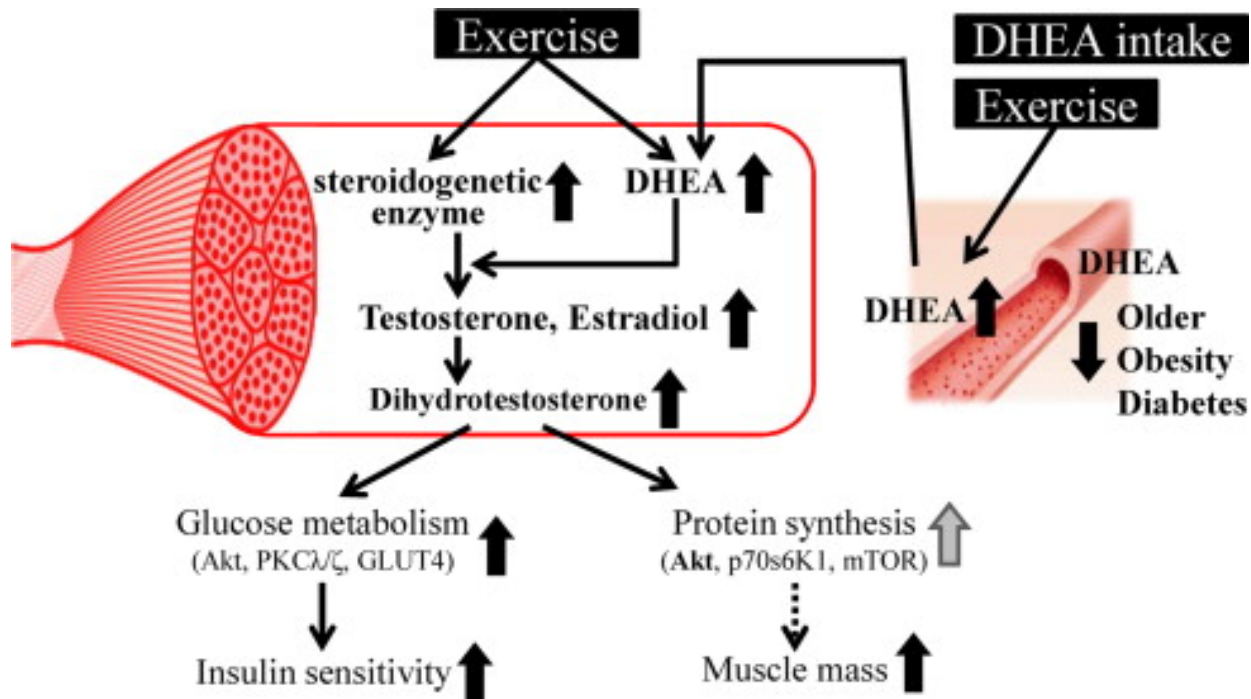

Fig. 1. Schematic illustration of the effect of exercise on muscle steroidogenesis, potentially resulting in prevention and treatment of life-related diseases.

AROMATASE IN THE BRAIN: IMPORTANT DATES

- **Early 1970s:** Paul MacDonald, Pentti Siiteri and collaborators made the discovery of extra-glandular aromatase activity on both men and women.
- **1971:** Frederick Naftolin and collaborators first demonstrated the presence of aromatase in primate brain. *Journal of Clinical Endocrinology & Metabolism*. 1971. 33: 368-370.
- **December 1981:** Several presentations highlighted the importance of aromatase for a range of biological processes in the brain. International Symposium on aromatase at Key Biscayne, Florida.
- **1999.** Some encephalic regions can synthesize estradiol *de novo* from cholesterol. Zwain, I.H., Yen, S.S., 1999. *Endocrinology* 140, 3843–3852.
- **2003-5.** Different groups independently observed that aromatase knock out animals demonstrated behavioural activity mimicking obsessive compulsive disorder. *Brain Research*. 2005. *Molecular* (1-2): 127-132.

BRAIN AROMATASE DISTRIBUTION

- The enzyme aromatase, which converts androgens into oestrogens, is widely expressed in neurons from different brain regions of male and female animals.
- These include brain areas involved in reproductive control and brain regions related to memory, emotion and cognitive processing. For example, in humans, aromatase immunoreactivity has been detected in, among other brain structures, pyramidal neurons and some interneurons in the cerebral cortex and the hippocampus.
- In addition, aromatase has been detected at synapses in birds and mammals
- The relative abundance of aromatase expression in these sites is developmentally regulated.
- Neurons and radial glia cells express aromatase under physiological conditions
- Astrocytes express aromatase under pathological conditions
- Aromatase has been detected in the soma, dendrites and pre-synaptic boutons of neurons.

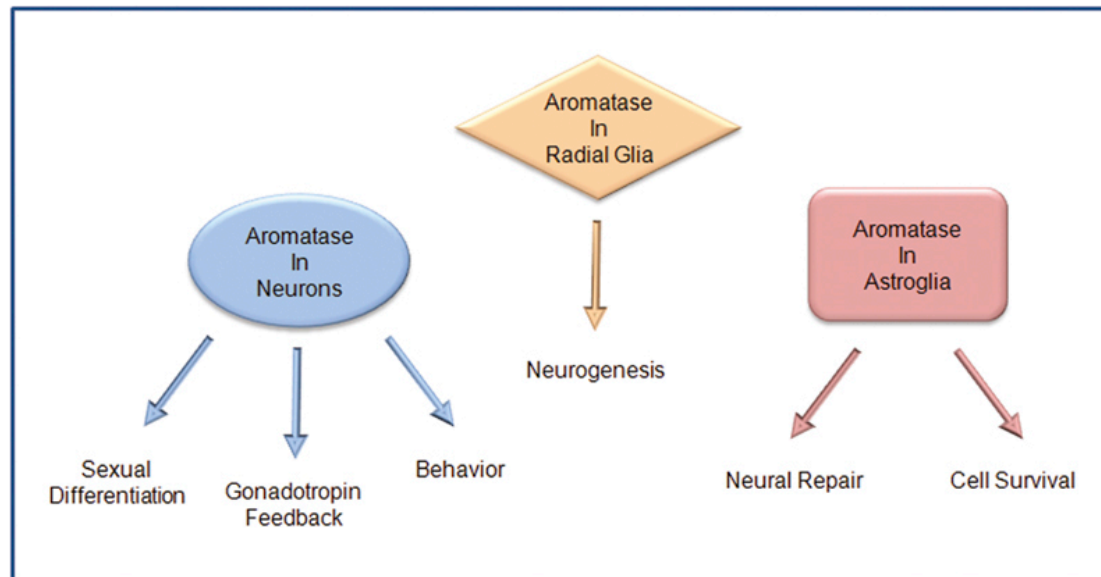

ROLES OF AROMATASE IN BRAIN

Classical roles

Sexual differentiation and dimorphism

Reproduction

Non classical roles

Neuroprotection

Neuroplasticity

Cell growth and migration

Other roles

Modulation of mood, affective status, aggressive behavior, memory and cognitive functions.

REGULATION OF BRAIN AROMATASE.

EXPRESSION

At least two populations of aromatase-positive cells:

1- steroid dependent where aromatase expression is regulated by gonadal steroids (preoptic area and hypothalamus)

2- steroid independent where gonadal steroids do not regulate aromatase expression

ACTIVITY

- Substrate levels
- Synaptic input
- Natural and non-natural inhibitors
- ???

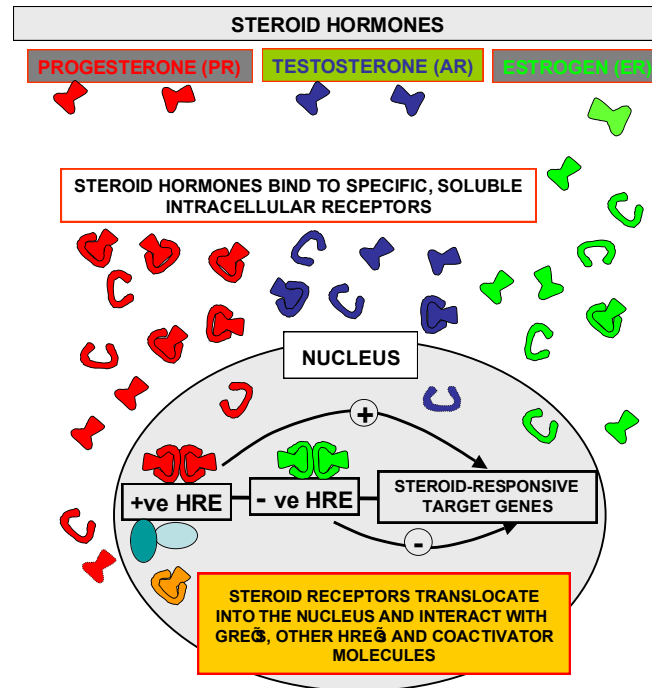

REGULATION OF BRAIN AROMATASE.

- Recent findings indicate that oestradiol synthesis in the hippocampus is regulated by gonadotropin-releasing hormone, which may coordinate oestradiol synthesis in the brain and the ovary.

- Furthermore, aromatase activity, and therefore oestradiol production, is rapidly regulated in the brain by glutamatergic synapses.

- The synaptic location of aromatase, together with the rapid regulation of its activity by neurotransmitters, suggests that brain-derived oestradiol acts as a rapid neuromodulator in synaptic circuits.

- Indeed, rapid changes in brain aromatase activity are linked to swift changes in synaptic function, neuronal activity and behaviour.

- Thus, local oestradiol synthesis in the brain, modulated by rapid changes in aromatase activity, seems to play an important part in the regulation of brain function and behaviour under physiological conditions.

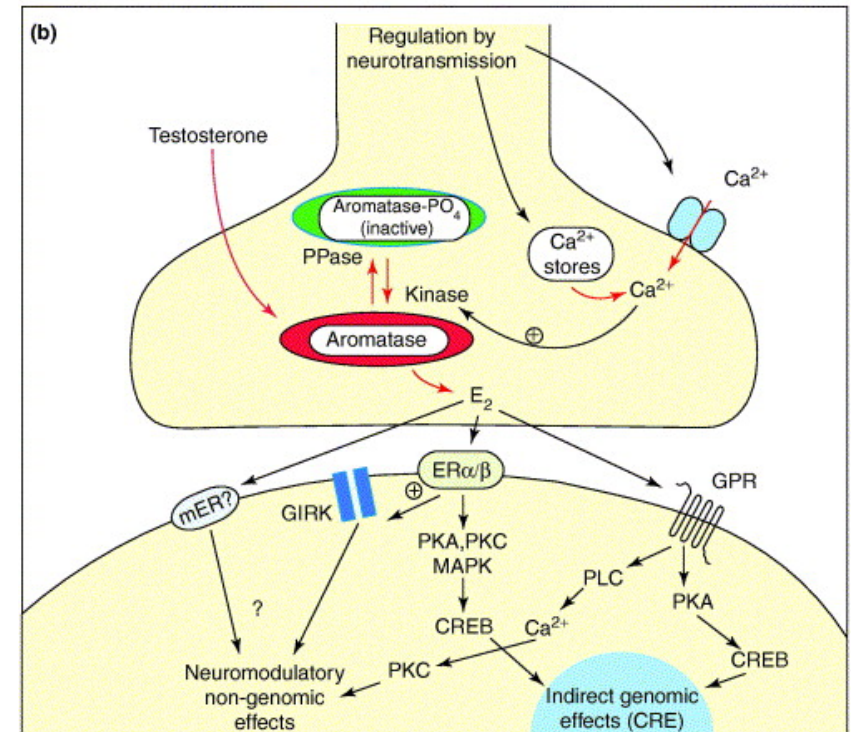
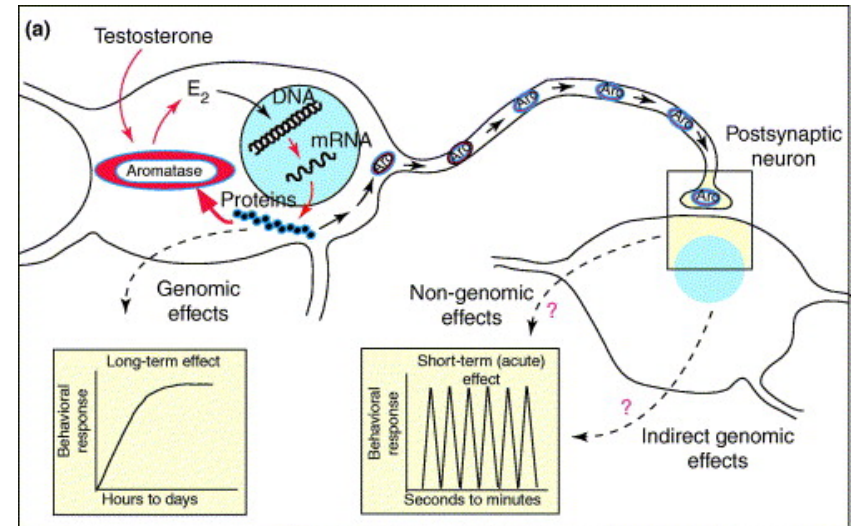

FAST REGULATION OF BRAIN AROMATASE

Aromatase activity is markedly decreased by Ca^{2+} dependent phosphorylation much more rapidly than by changes in enzyme concentration.

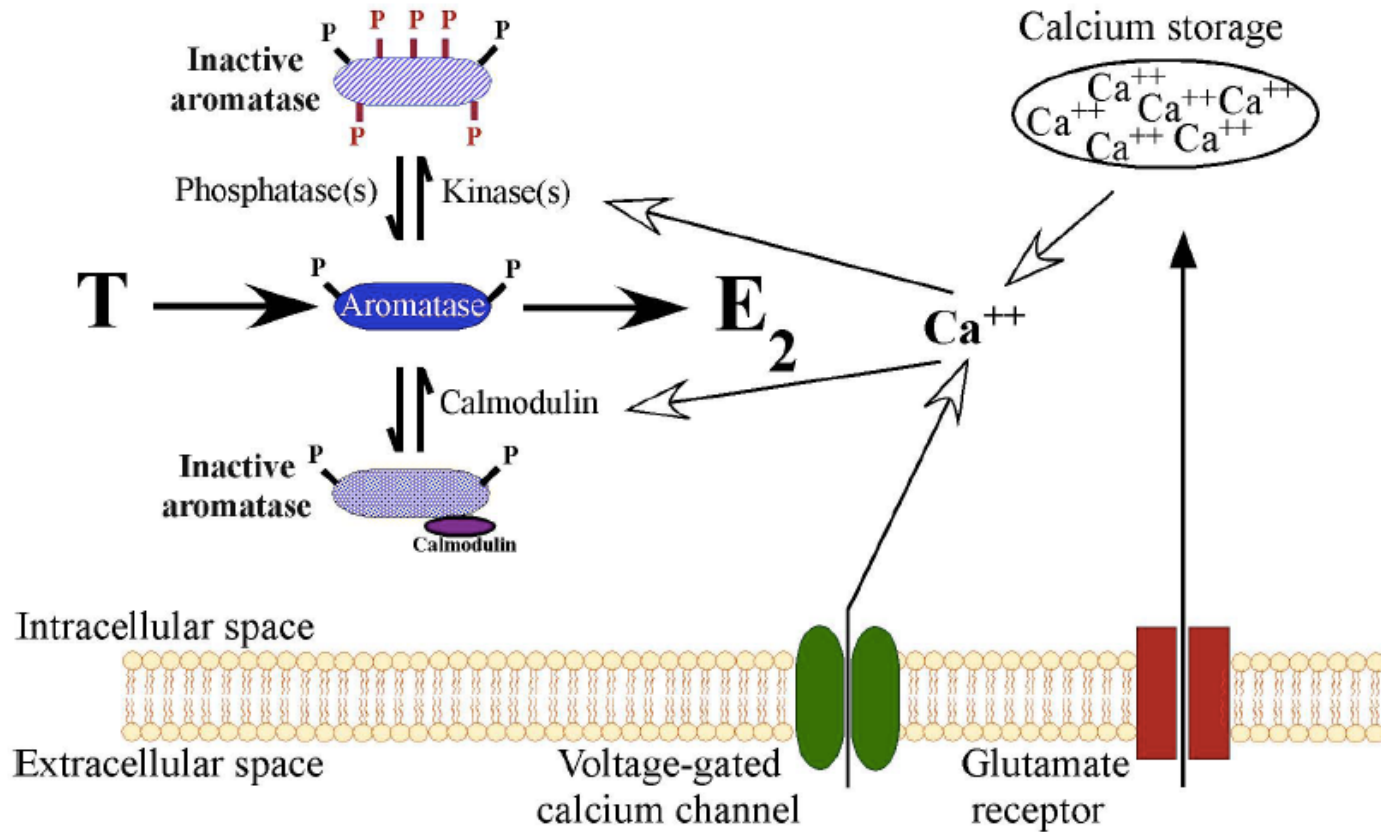

Figure 2. Localization of aromatase-expressing cells in the brain regions investigated for the rapid modulation of enzymatic activity (POM and NCM), in Japanese quail (A) and zebra finch (C-D). Dots represent regions where aromatase is present, as confirmed by immunohistochemistry, in situ hybridization, and aromatase activity assays.

FAST REGULATION OF BRAIN AROMATASE

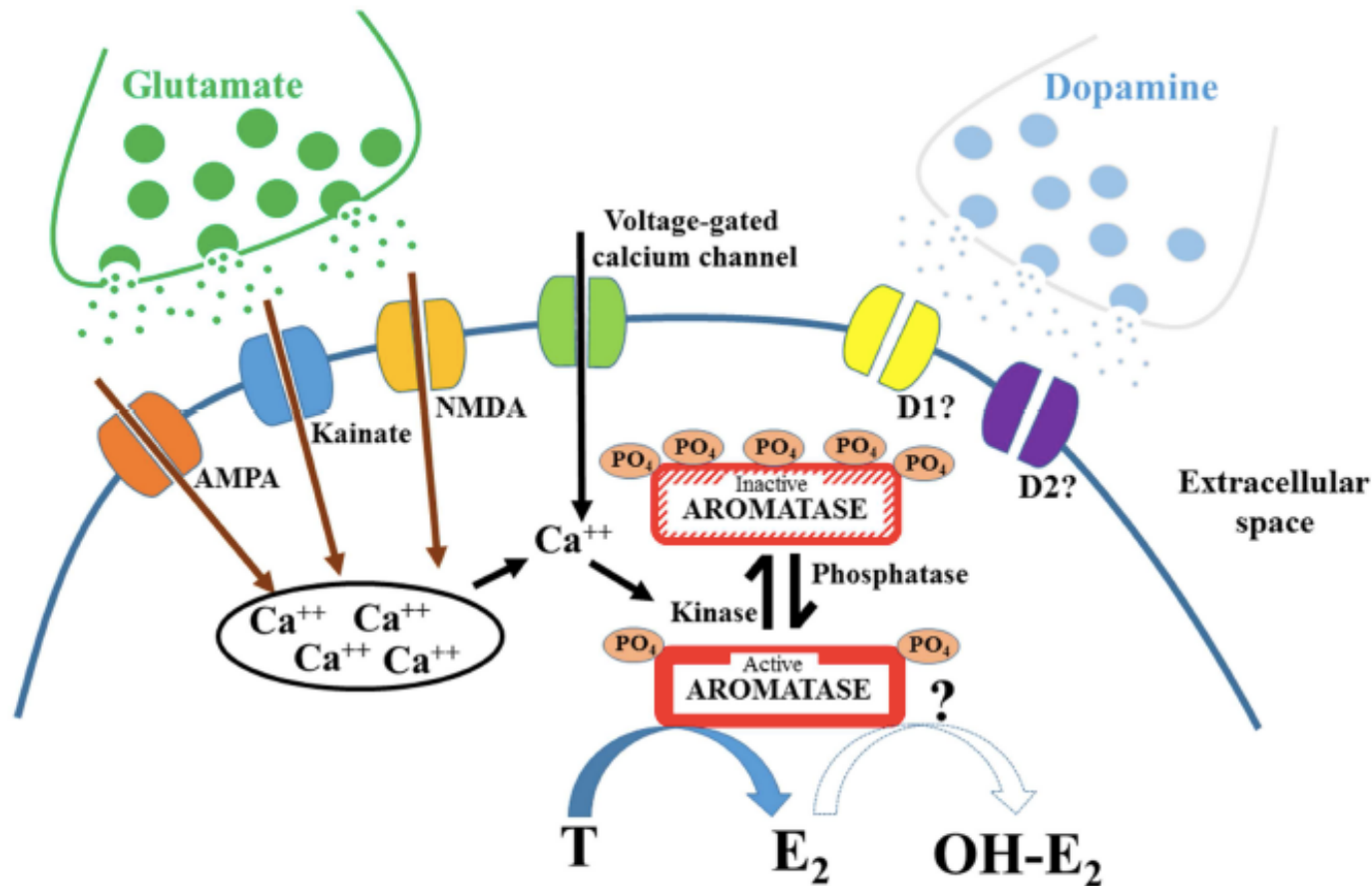

FIGURE 1 | Schematic diagram representing the mechanisms involved in the rapid control of aromatase activity.

Phosphorylations (PO_4) rapidly modulate aromatase activity, inhibiting the transformation of testosterone (T) into 17β -estradiol (E_2). It is likely that these modifications are induced by calcium-voltage channels, by

glutamatergic receptors and/or by dopaminergic receptors. The increase of intracellular calcium (Ca^{++}), either from intracellular storage or from the activation of voltage-gated channel is in most cases a prerequisite for the inhibition of aromatase activity. Change in phosphorylation level could also affect the hydroxylase activity of aromatase.

FAST REGULATION OF BRAIN AROMATASE

Is brain estradiol a neurotransmitter?

Several criteria have been established for a molecule to be considered as a neurotransmitter/neuromodulator:

- (i) synthesis and storage in presynaptic vesicles
- (ii) release upon stimulation in the synaptic cleft in concentrations sufficient to activate post-synaptic receptors
- (iii) specificity for a defined receptor so that action can be blocked by specific antagonists
- (iv) the presence of inactivation mechanisms (e.g. catabolism or reuptake).

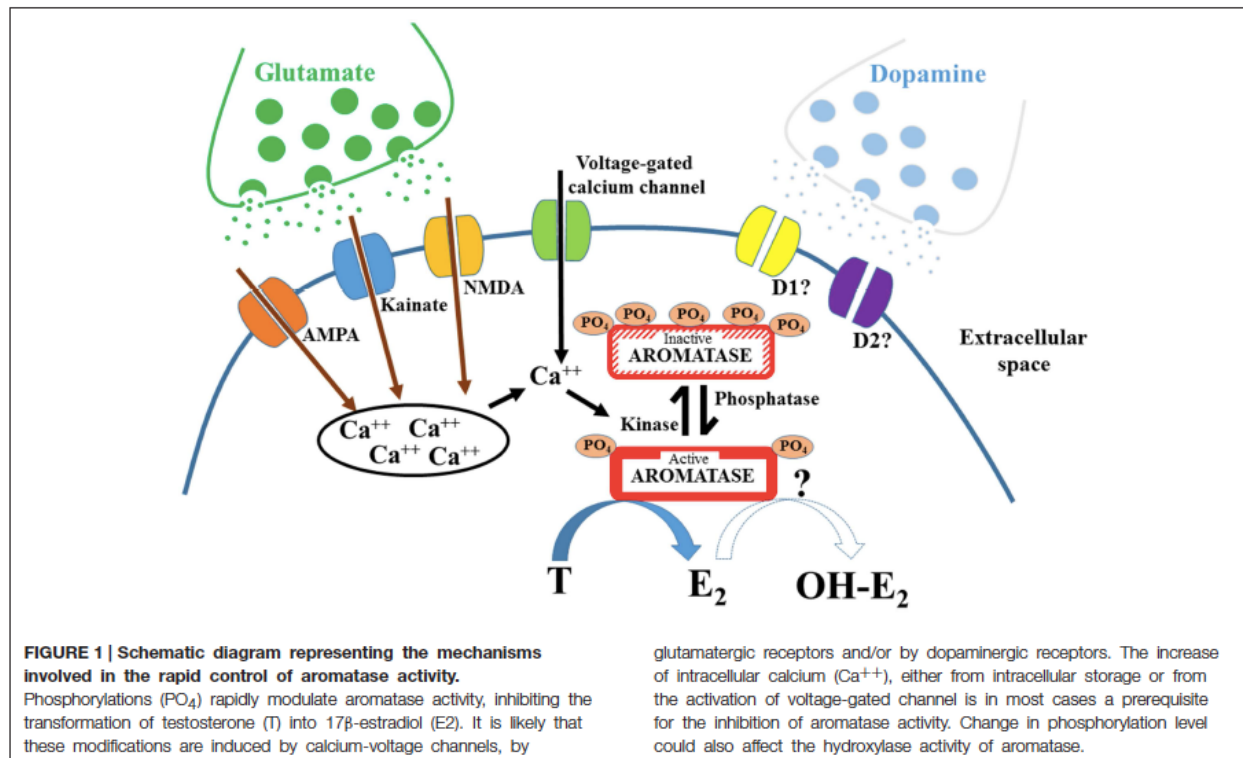

NEUROPROTECTIVE ROLE OF BRAIN AROMATASE

- An important indication of the role of brain-derived oestradiol in neuroprotection was provided by the observation that, in rodents and birds, the brain responds to an acute injury by increasing the expression and activity of aromatase.
- In humans, the decline in oestradiol levels with menopause is associated with an increased risk of cognitive impairment, affective disorders and even Alzheimer's disease pathology.
- An important point to consider is that brain-derived oestradiol is neuroprotective in both male and female animals. In males, aromatase may use circulating testosterone as a precursor to generate oestradiol.
- The importance of aromatase as a neuroprotective molecule in humans is suggested by the existence of genetic variants of the enzyme that confer an increased risk for Alzheimer's disease.
- These genetic variants of aromatase may result in decreased oestradiol synthesis in the brain, which, together with decreased serum oestradiol levels in postmenopausal women or serum testosterone levels in aged men, may increase the risk for developing neurodegenerative diseases.

ALZHEIMER'S DISEASE AND HUMAN AROMATASE

In **mouse models** estrogens deficiency promotes β amyloid plaques formation

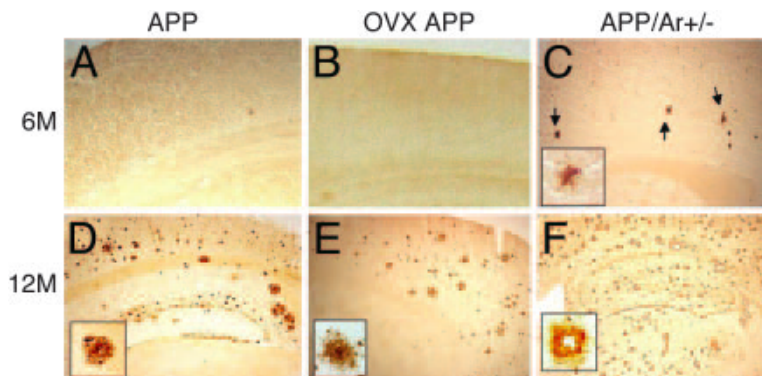

From Yue *et al.*, 2005 *PNAS*

Vol 12: 19198-19203

Human aromatase SNPs were found in linkage disequilibrium with Alzheimer's disease

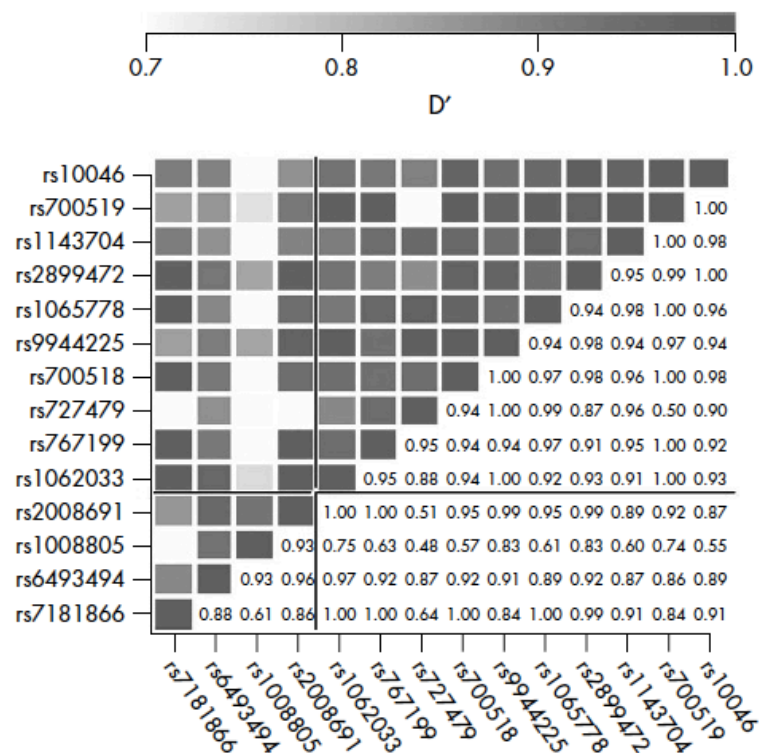

From Huang and Poduslo, 2006 *J. Med. Genet.*

Vol 43: e42

POLYMORPHISMS IN HUMAN AROMATASE

44 SNPs on the coding sequence

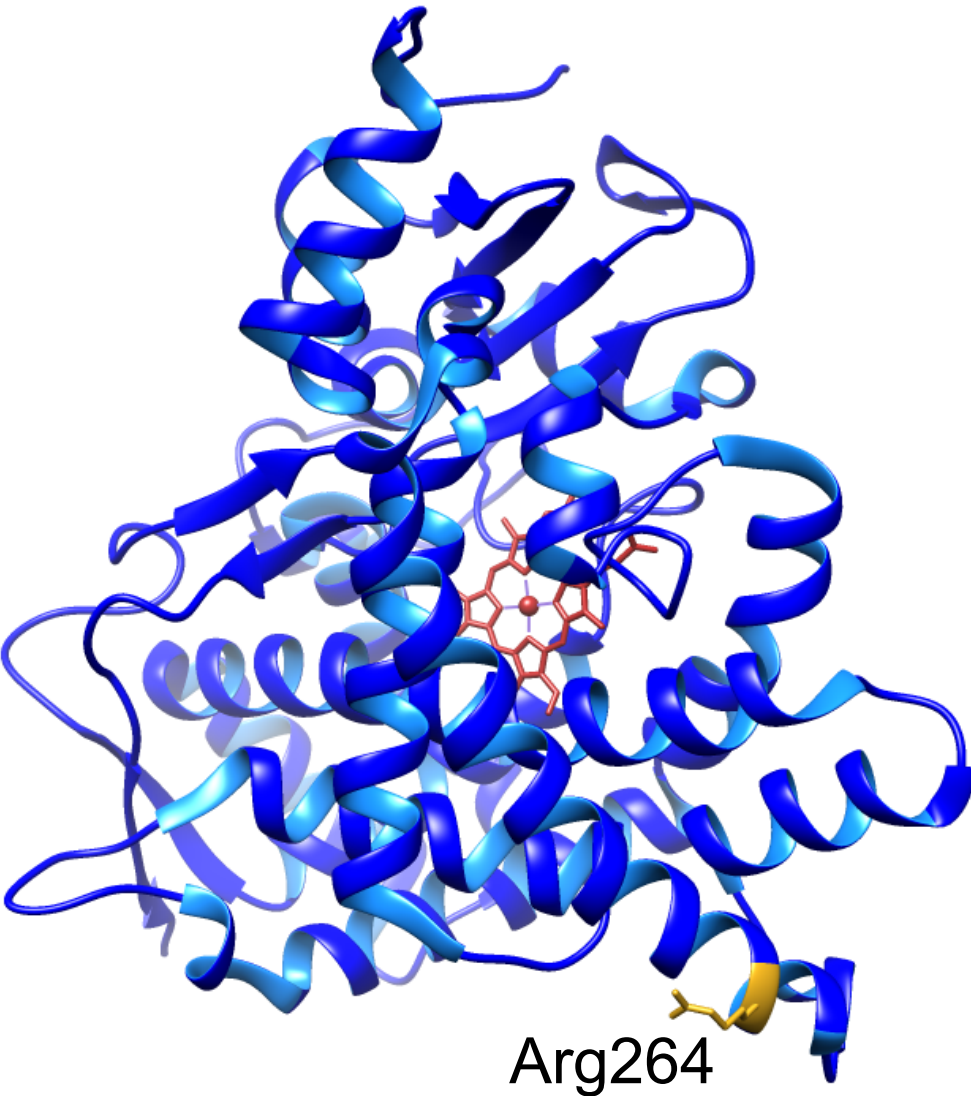

rs700519: Arg264Cys

rs2304462: Arg264His

POLYMORPHISMS IN HUMAN AROMATASE

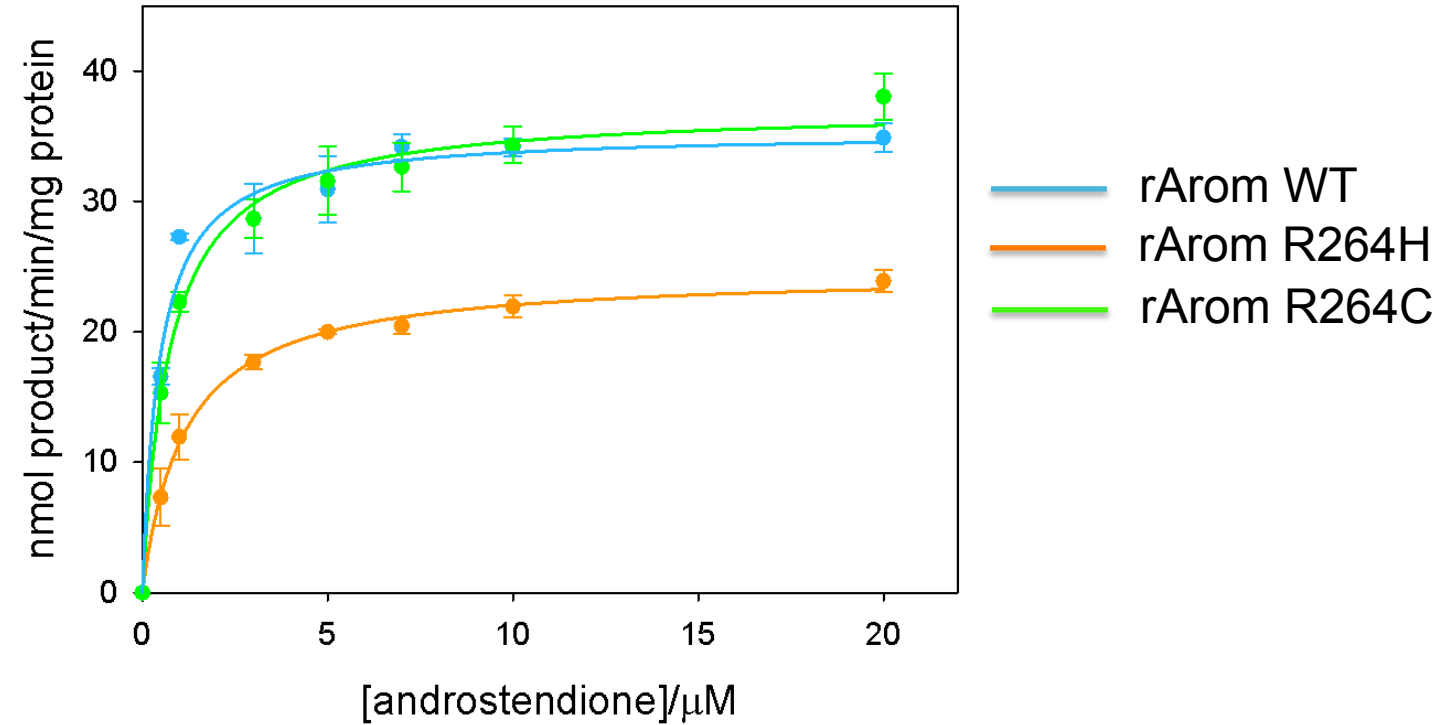

rArom variant	K _M (μM)	V _{MAX} (nmol/min/mg)
WT	0.46 ± 0.05	35.3 ± 0.7
R264H	1.14 ± 0.10*	24.6 ± 0.5*
R264C	0.74 ± 0.07	37.2 ± 0.7

* P-value < 0.001 by ANOVA test

POLYMORPHISMS IN HUMAN AROMATASE

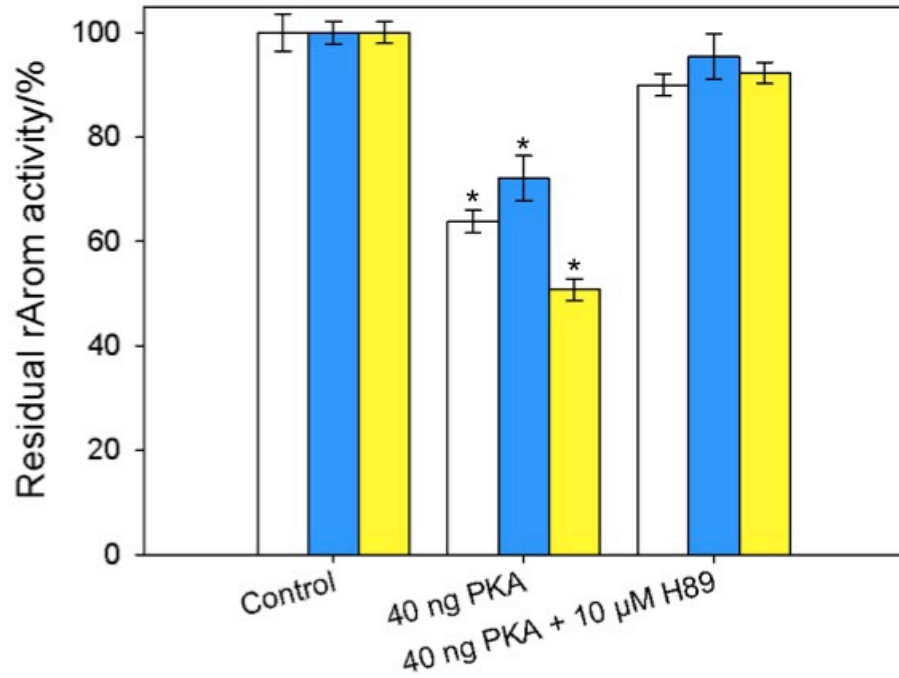

* P-value < 0.001 by ANOVA test

rArom variant	rArom activity (%)		
	w/o treatment	In the presence of PKA	In the presence of inhibited-by-H89 PKA
WT	100 ± 3.5	63.8 ± 2.1 *	89.9 ± 2.1
R264H	100 ± 4.3	72.1 ± 4.3 *	95.4 ± 4.3
R264C	100 ± 2.0	50.7 ± 2.0 *	92.3 ± 2.1

NEUROPROTECTIVE ROLE OF BRAIN AROMATASE

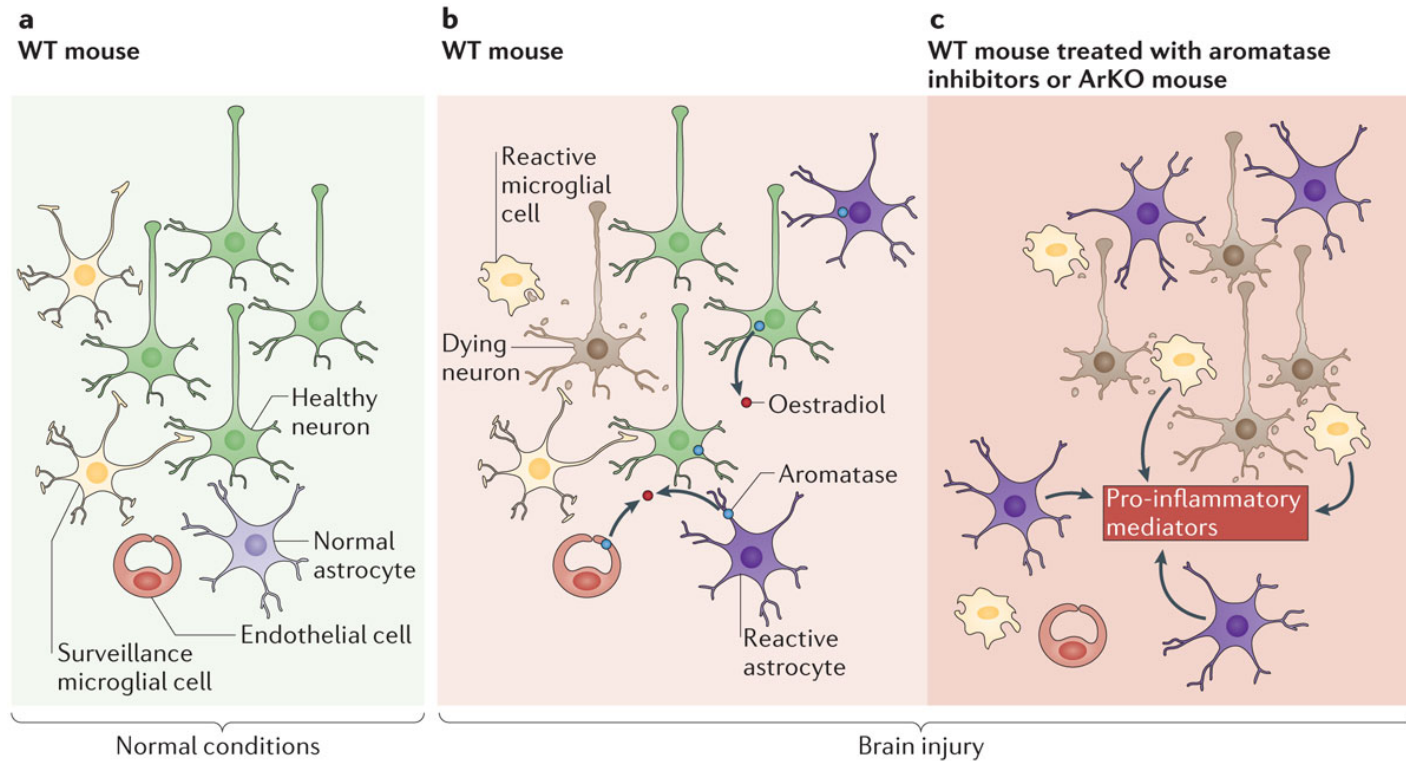

Nature Reviews | Neuroscience

Figure 1: Neuroprotective actions of brain aromatase. **a** | Under normal conditions, astrocytes in wild-type (WT) mice do not express the oestradiol-synthesizing enzyme aromatase. **b** | After an acute brain injury, reactive gliosis (including the conversion of surveillance microglia to reactive microglia) and neuron death occur. However, in the WT mouse brain injury also causes astrocytes to become reactive and express aromatase. Aromatase expression is also observed in neurons and endothelial cells. The increased oestradiol levels resulting from the enhanced expression and activity of aromatase protect neurons and reduce reactive gliosis, as shown on the right of the panel. **c** | Neuronal degeneration and reactive gliosis, with the subsequent release of pro-inflammatory mediators by astrocytes and microglia, is enhanced after the pharmacological inhibition of brain aromatase or in aromatase-knockout (ArKO) mice.

NEUROPROTECTIVE ROLE OF BRAIN AROMATASE

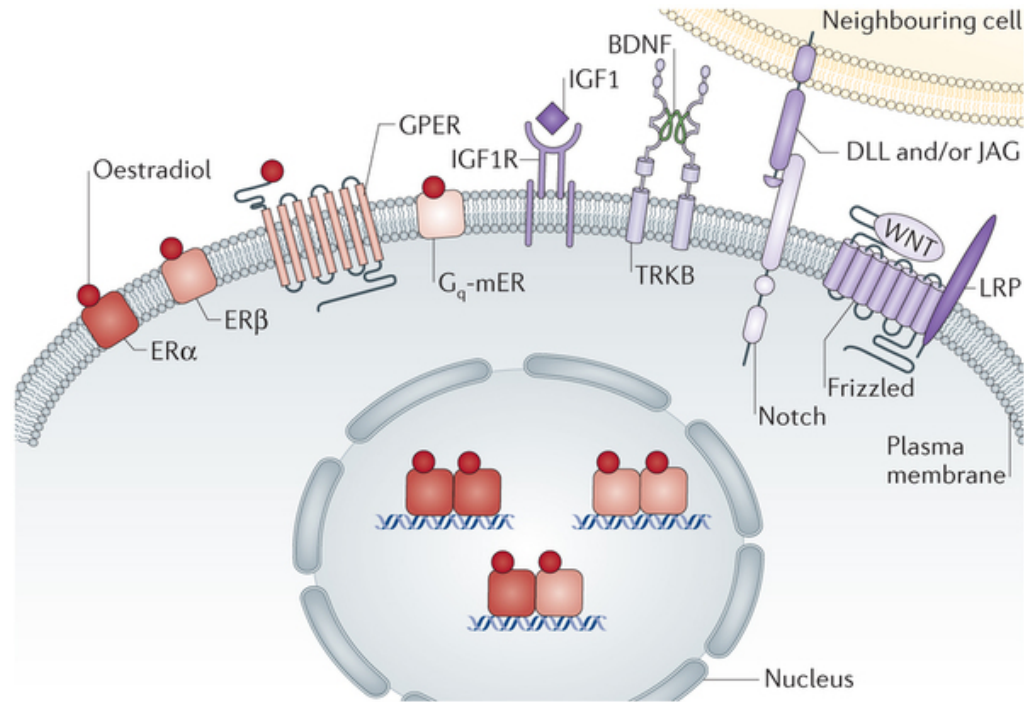

Nature Reviews | **Neuroscience**

Figure 2: Oestradiol activates multiple neuroprotective signalling mechanisms. Oestradiol binds to various oestrogen receptors (ERs). The classical ERs (ER α and ER β) are transcription factors that, after oestradiol binding, form homodimers or heterodimers and regulate transcription. ER α and ER β are also associated with the plasma membrane, where they activate different signalling cascades. Oestradiol also activates neuroprotective signalling by binding to other membrane receptors, such as G protein-coupled ER (GPER) and G α_q protein-coupled membrane ER (Gq-mER). In addition, oestradiol promotes neuroprotection by an indirect regulation of the signalling of other receptors, such as insulin-like growth factor 1 (IGF1) receptor (IGF1R), the brain-derived neurotrophic factor (BDNF) receptor TRKB, Notch — a receptor involved in cell-to-cell communication that is activated by membrane ligands in adjacent cells, such as Delta (DLL) and Jagged (JAG) — and the WNT receptor complex, which is composed of Frizzled and lipoprotein receptor-related protein (LRP).

HUMAN AROMATASE AND PATHOLOGIES

Overproduction

Breast cancer

Endometrial cancer

Polycystic ovary
syndrome



ESTROGENS

Deficiency

Alzheimer's disease

Parkinson's disease

Osteoporosis

Altered A:E ratio

Obesity

Thrombosis

AROMATASE AND BREAST CANCER

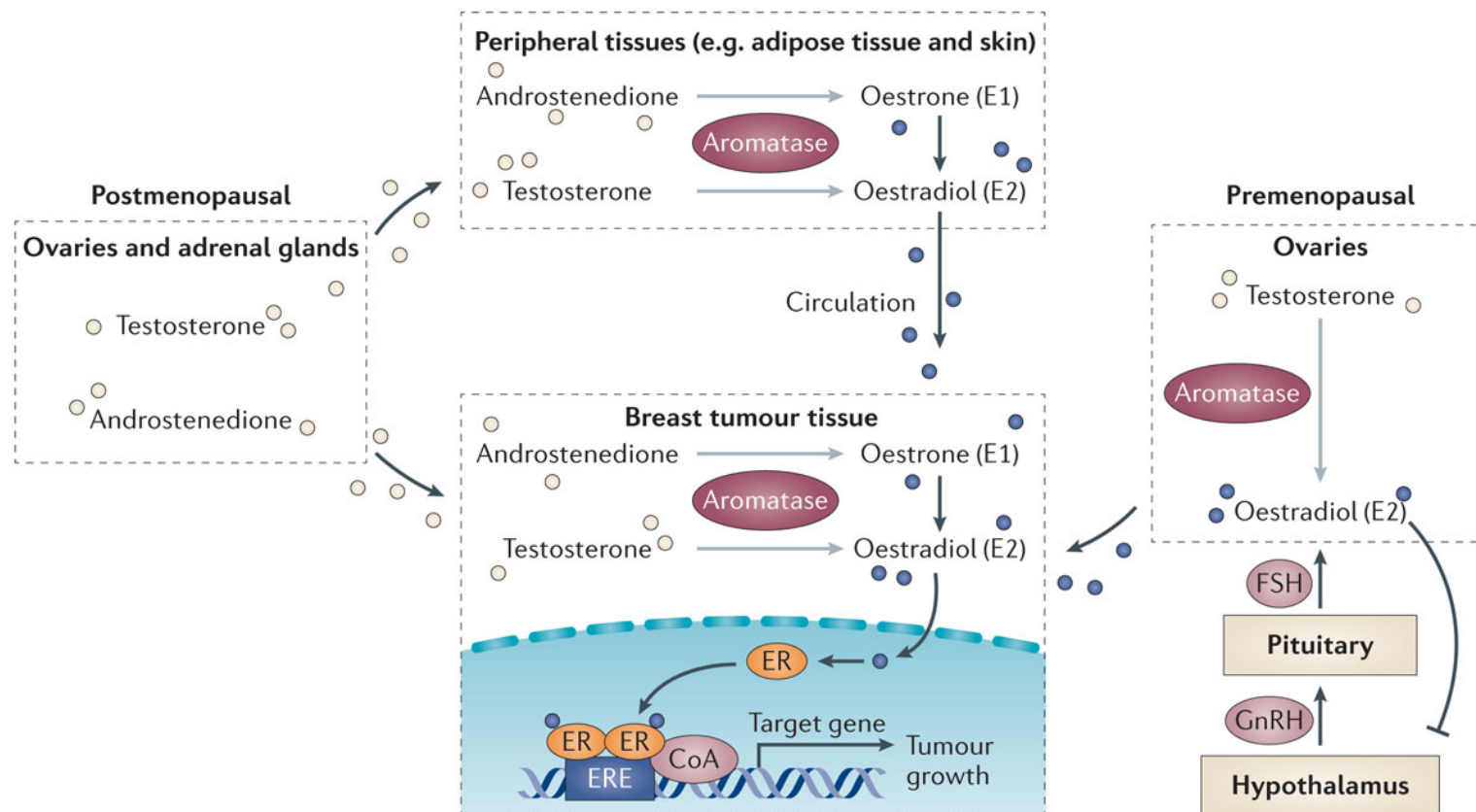

Nature Reviews | Cancer

In premenopausal women, the ovaries are the major source of oestrogen, and oestrogen biosynthesis is regulated by the hypothalamus and pituitary gland via the actions of gonadotropin-releasing hormone (GnRH) and follicle-stimulating hormone (FSH). In postmenopausal women, oestrogen is synthesized in peripheral tissues such as adipose tissue, breasts and skin through the action of aromatase, which converts androstenedione and testosterone released from ovaries and adrenal glands to oestrone and oestradiol, respectively. In addition, oestrogen receptor-positive (ER+) breast cancer cells could express aromatase, leading to intratumoural oestrogen production. In postmenopausal women, aromatase inhibitors (AIs) effectively reduce oestrogen production. In premenopausal women, however, the reduced oestrogen levels by AIs induce feedback stimulation of the hypothalamus–pituitary–ovary axis; therefore, ovarian function suppression by GnRH agonists or ovarian ablation such as oophorectomy is required for AIs to be used in premenopausal women. CoA, co-activator; ERE, oestrogen response element.

AROMATASE INHIBITORS

- Used to inhibit estrogen-dependent tumors, metastatic breast cancer.
- But, serious estrogen-lacking side-effects: increased risk of osteoporosis.
- **Anastrozole, letrozole, exemestane.**

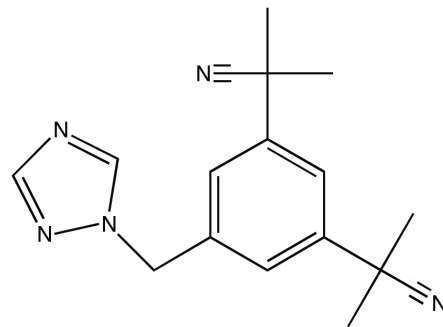

Anastrozole

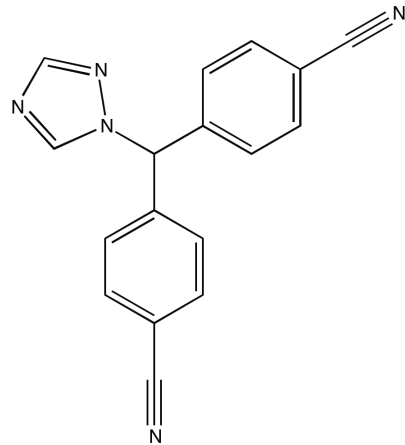

Letrozole

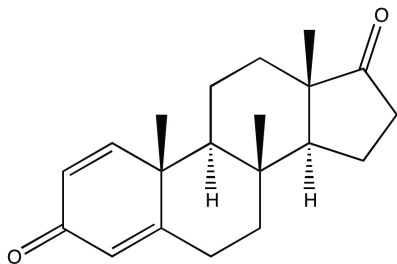

Exemestane

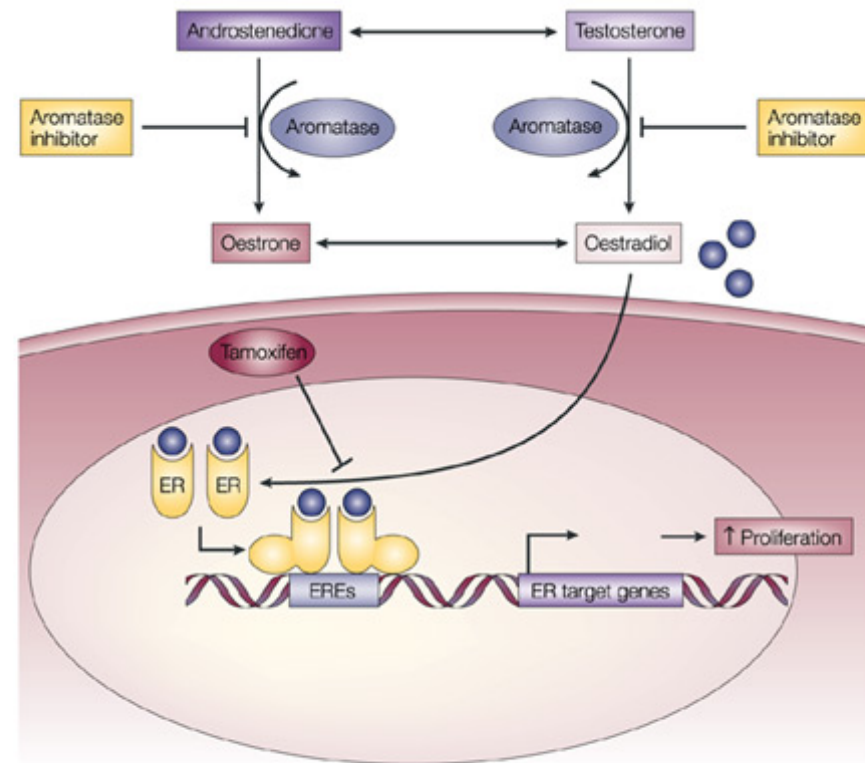

AROMATASE INHIBITORS

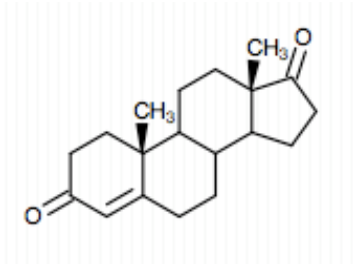

Androstenedione

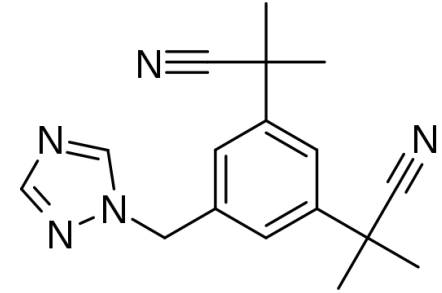

Anastrozole

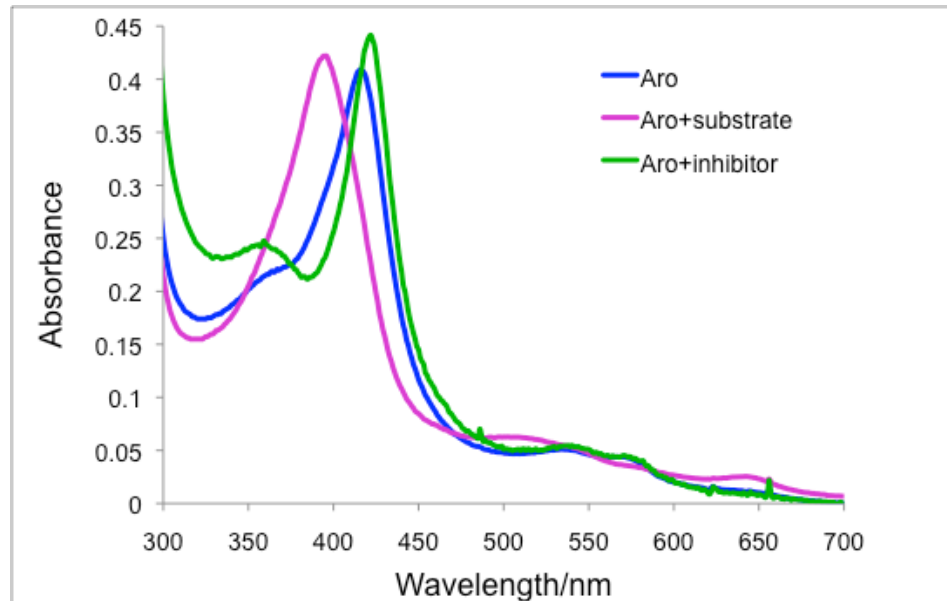

Electron Paramagnetic Resonance and Hyperfine Sublevel Correlation (HYSCORE)

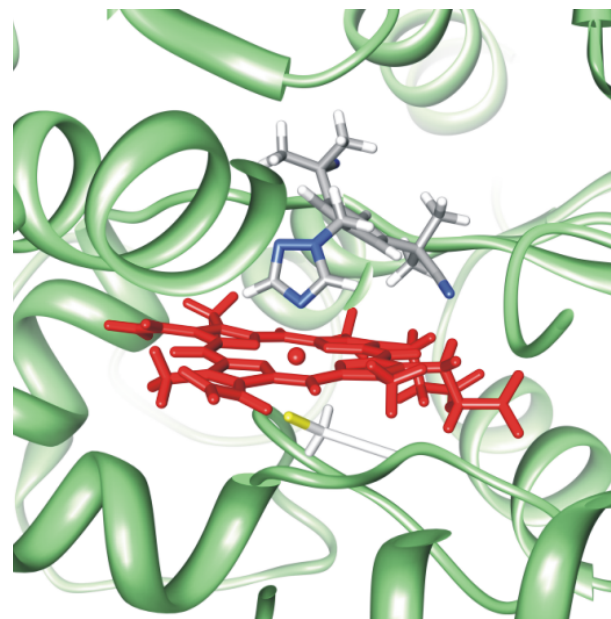
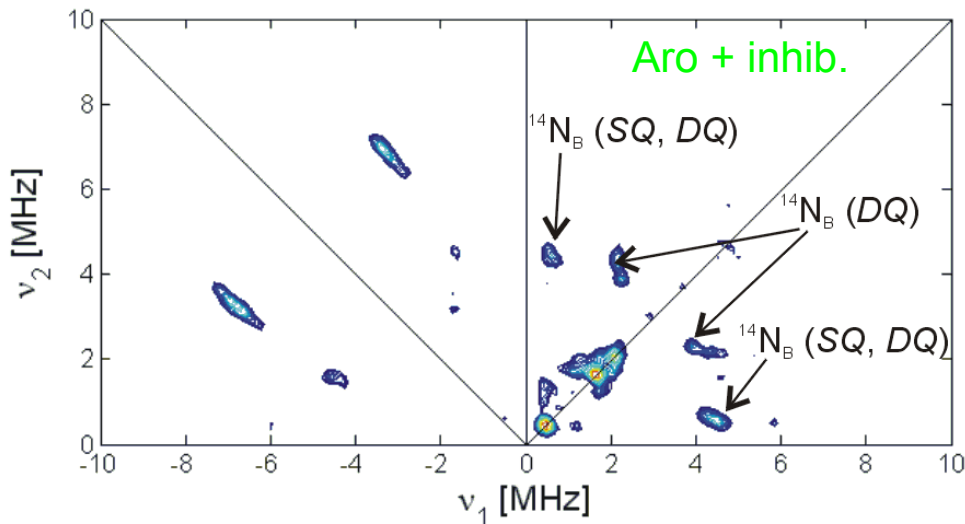
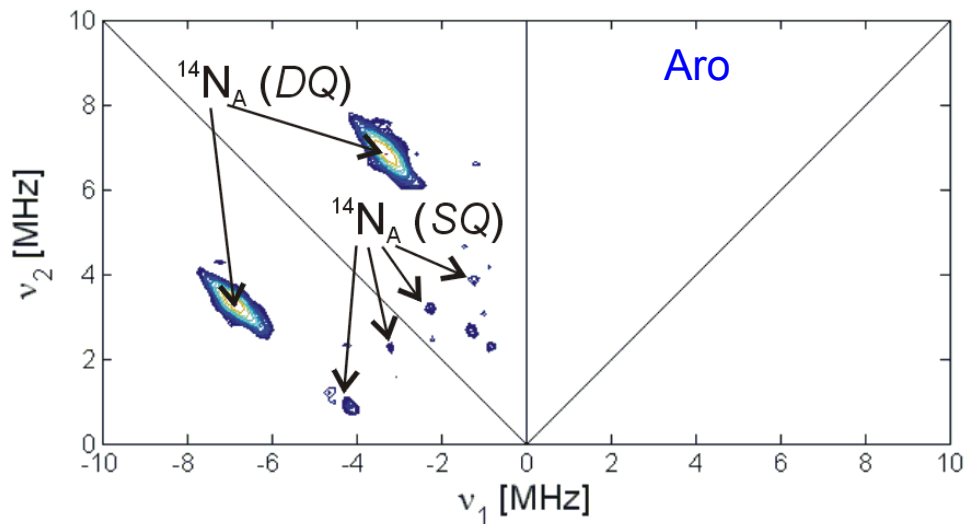

POLYMORPHISM AND BREAST CANCER

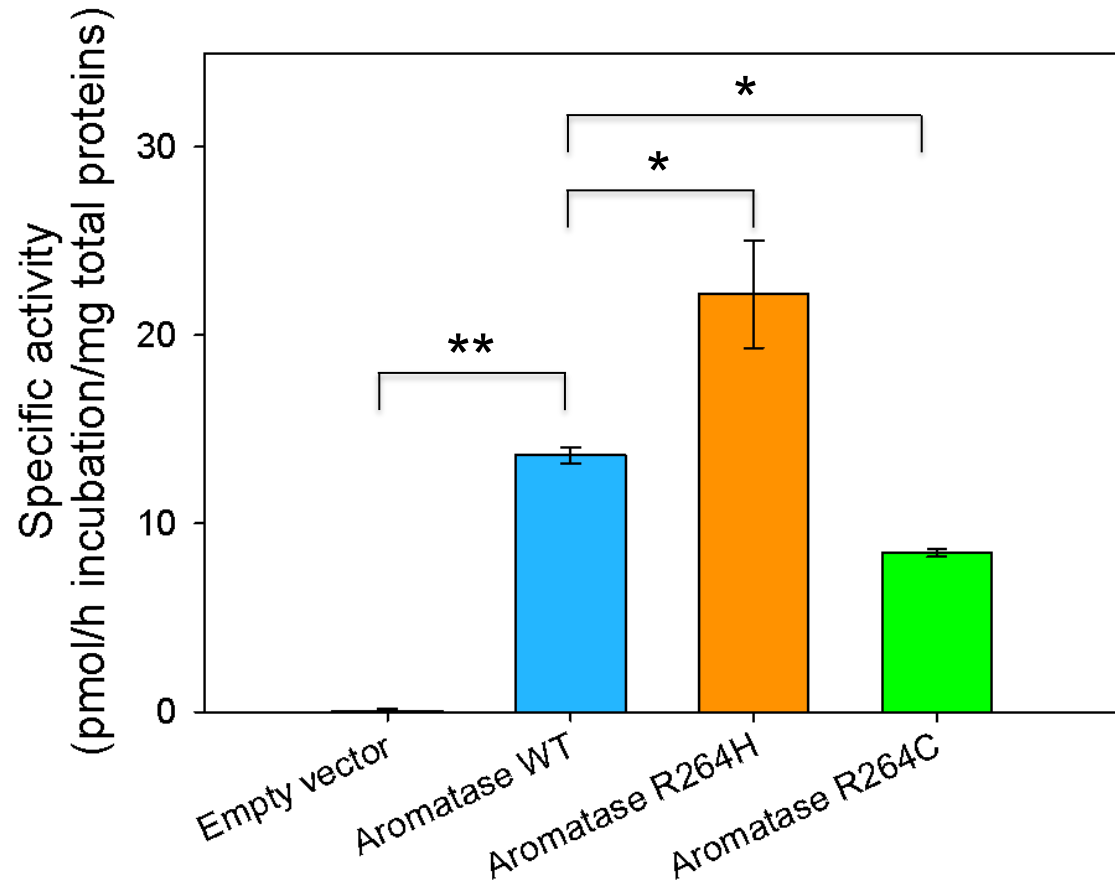
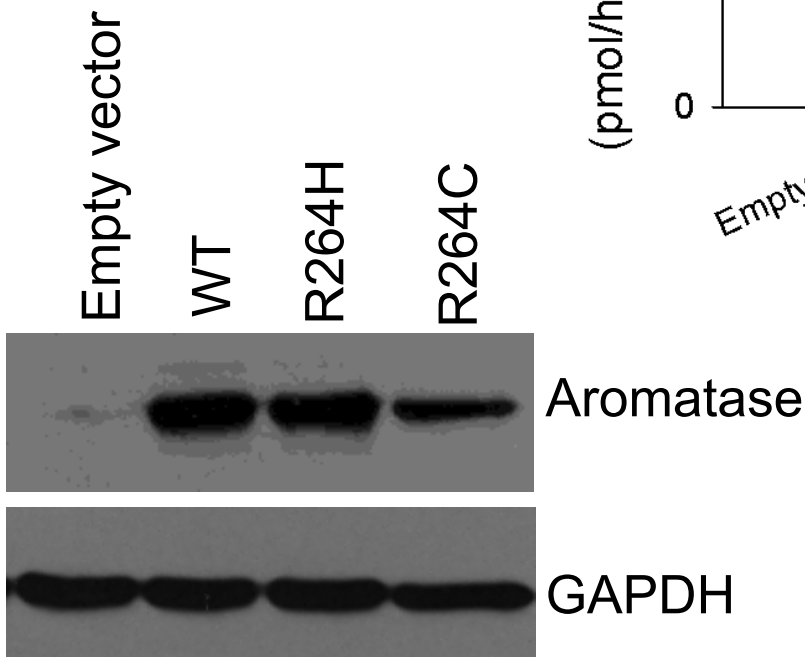

** P-value < 0.005 by ANOVA test

* P-value < 0.05 by ANOVA test

AROMATASE IN ENDOMETRIOSIS

- Aromatase is key for the biosynthesis of estrogen
- In patients aromatase expression is higher in endometriosis tissue than in normal endometrium
- In endometriosis tissue aromatase activity is stimulated by prostaglandin
- Estrogen synthesized by endometriotic tissue stimulates growth of lesions

