

Typical Eukaryotic Cell

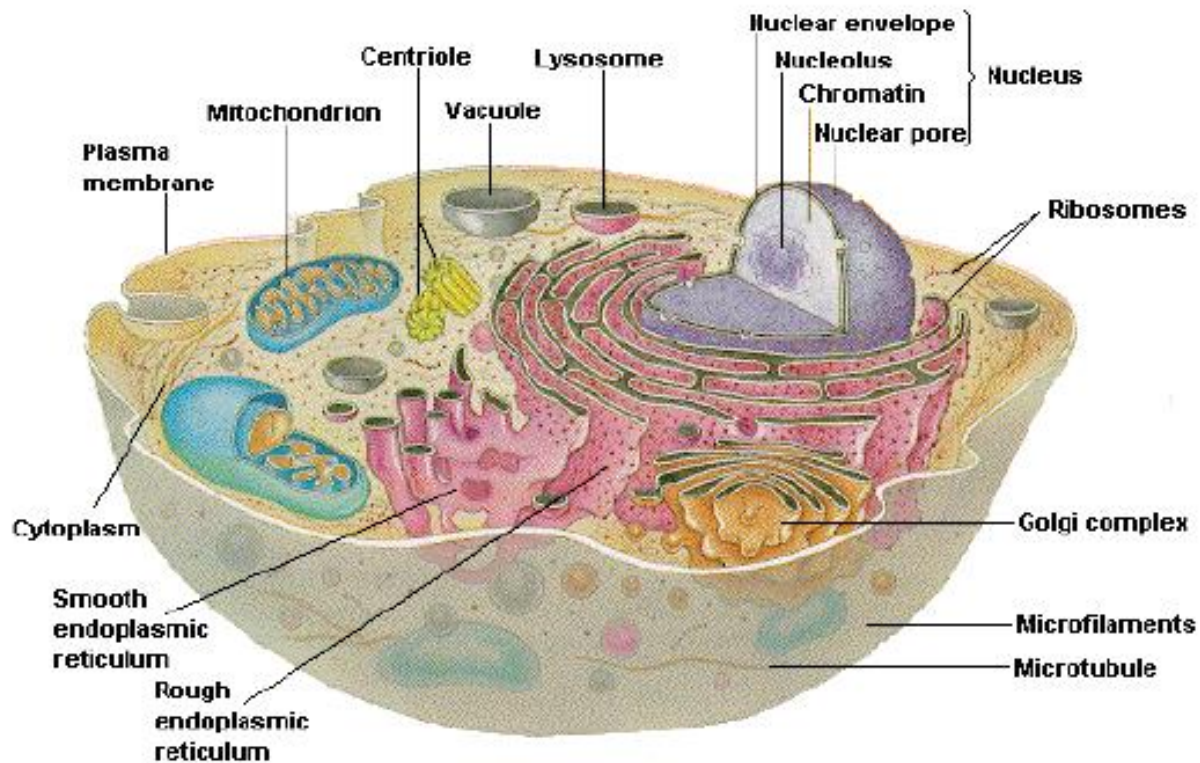

ORGANELLES

What is different in a neuron?

Cytoplasm

Plasma membrane

Nucleus

Mitochondria

smooth ER

rough ER

Golgi

Membrane Organelles

Lysosomes

Peroxisomes

Endosomes

Cytoskeleton

Microfilament

Intermediate filaments

Microtubules

Adherens Junctions

Centrioles

Cilia

Ribosomes

Proteosomes

ORGANELLES

What is different in a neuron?

Cytoplasm

Plasma membrane

Nucleus

Mitochondria

smooth ER

rough ER

Golgi

Membrane Organelles

Lysosomes

Peroxisomes

Endosomes

Cytoskeleton

Microfilament

Intermediate filaments

Microtubules

Adherens Junctions

Centrioles

Cilia

Ribosomes

Proteosomes

Neuronal plasma membrane

- Much much larger area than typical cell
 - Long axons and very complex dendrites, axon 20000 x soma size
- Unique electric properties- electrically active
 - many ion channels in neurons
 - K^+ , Cl^- , Na^+ , Ca^+ channels which determine electrical properties of cell.
- Different local domains with unique properties
 - Nodes of Ranvier, synaptic terminals, axon hillock, dendritic spines.

The neuronal plasma membrane contains several local domains with unique properties

FIGURE 2 Basic elements of neuronal subcellular organization. The neuron consists of a soma, or cell body, in which the nucleus, multiple cytoplasm-filled processes termed dendrites, and the (usually single) axon are placed. The neuron is highly extended in space; a neuron with a cell body of the size shown here could easily maintain an axon several miles in length! The unique shape of each neuron is the result of a cooperative interplay between plasma membrane components (the lipid matrix and associated proteins) and cytoskeletal elements. Most large neurons in vertebrates are myelinated by oligodendrocytes in the CNS and by Schwann cells in the PNS. The compact wraps of myelin encasing the axon distal to the initial segment permit the rapid conduction of the action potential by a process termed "saltatory conduction" (see Chapter 3).

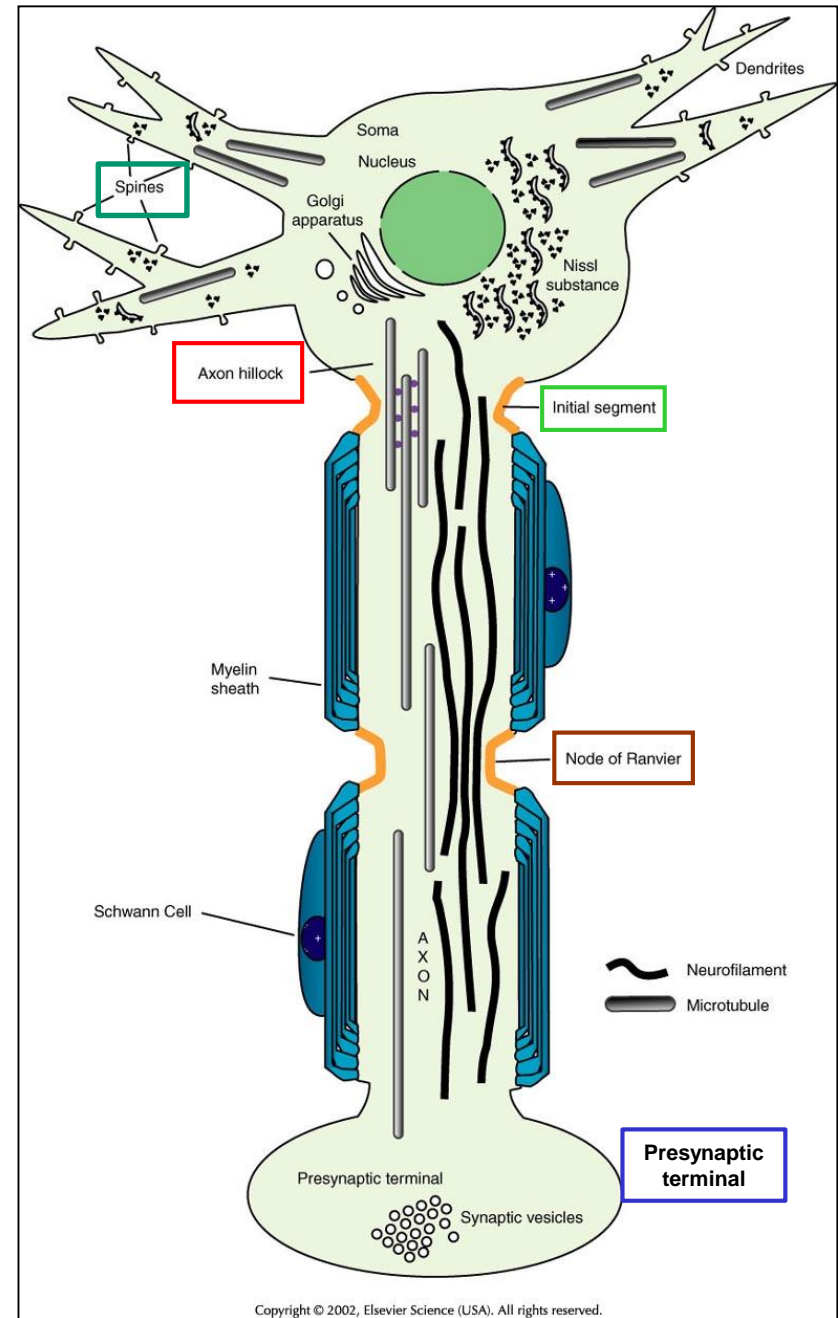

Endoplasmic Reticulum

- important source of calcium
- rER site of translation and insertion of membrane proteins
- rER extensive in many neurons and a major component of Nissl bodies
- Spine apparatus a specialized ER compartment

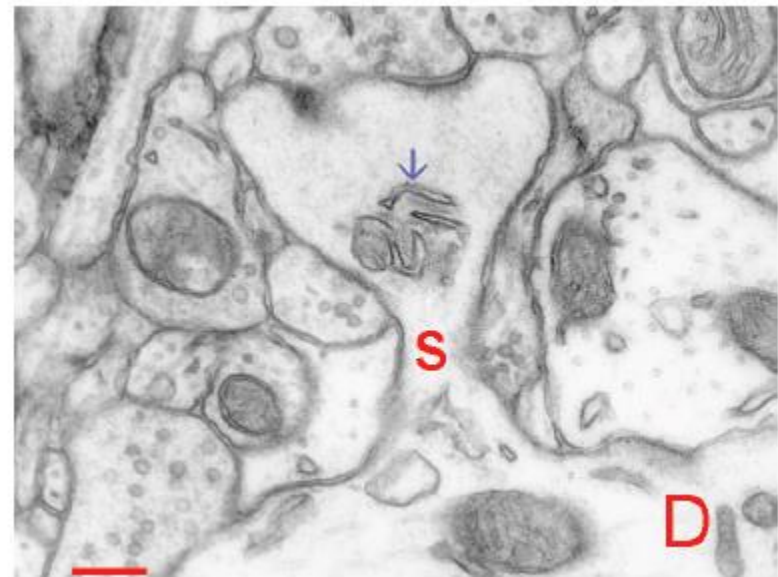
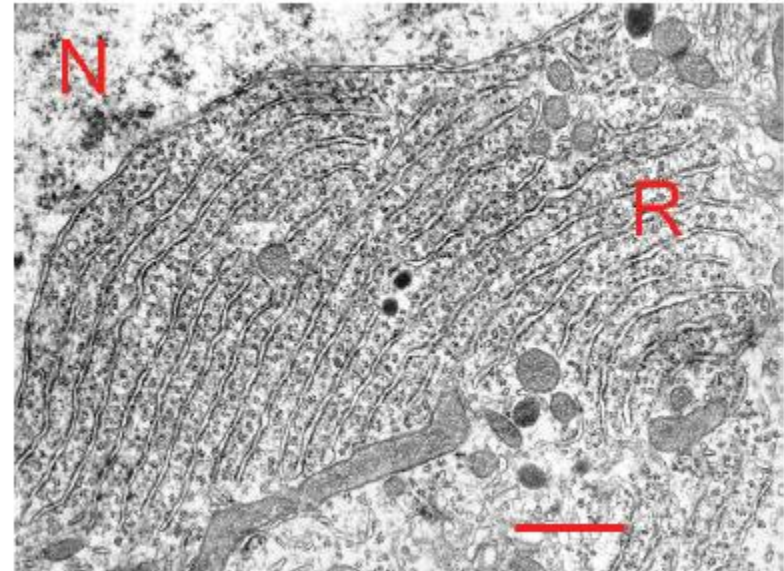

Where is the protein synthesis machinery in neurons?

In neurons the **Nissl bodies** are present in the soma and dendrites

FIGURE 1 The "Nissl body" in neurons is an array of cytoplasmic-free polysomal rosettes (boxed) interspersed between rows of rough endoplasmic reticulum (RER) studded with membrane-bound ribosomes. Nascent polypeptide chains emerging from the ribosomal tunnel on the RER are inserted into the lumen (arrow), where they may be processed before transport out of the RER. The relationship between the polypeptide products of these "free" and "bound" polysome populations in the Nissl body, an arrangement that is unique to neurons, is unknown.

Polyribosomes are located at the basal portion of dendritic spines

Protein targeting in dendritic spines is regulated by local synthesis

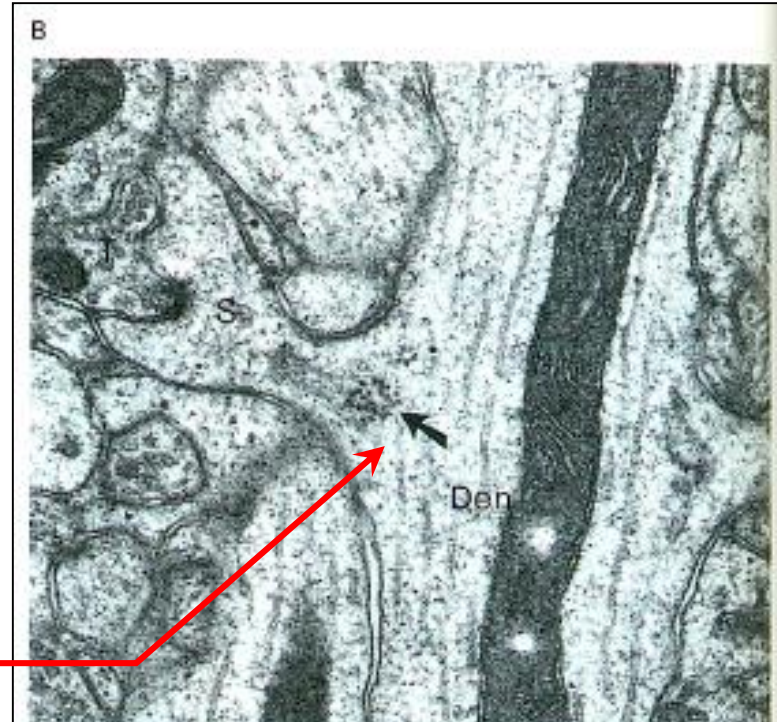

B. Polyribosomes in dendrites are selectively located beneath postsynaptic sites. In spine-bearing neurons clusters of polyribosomes are generally found just at the junction of the spine and the main dendritic shaft (arrow). This electron micrograph shows a mushroom-shaped spine synapse in the hippocampal dentate gyrus. (S = spine head; T = presynaptic terminal; Den = main shaft of the dendrite containing a long mitochondrion.) Note the absence of polyribosomes in other parts of the dendritic shaft. $\times 60,000$. (Courtesy of O. Steward, University of Virginia.)

The Golgi

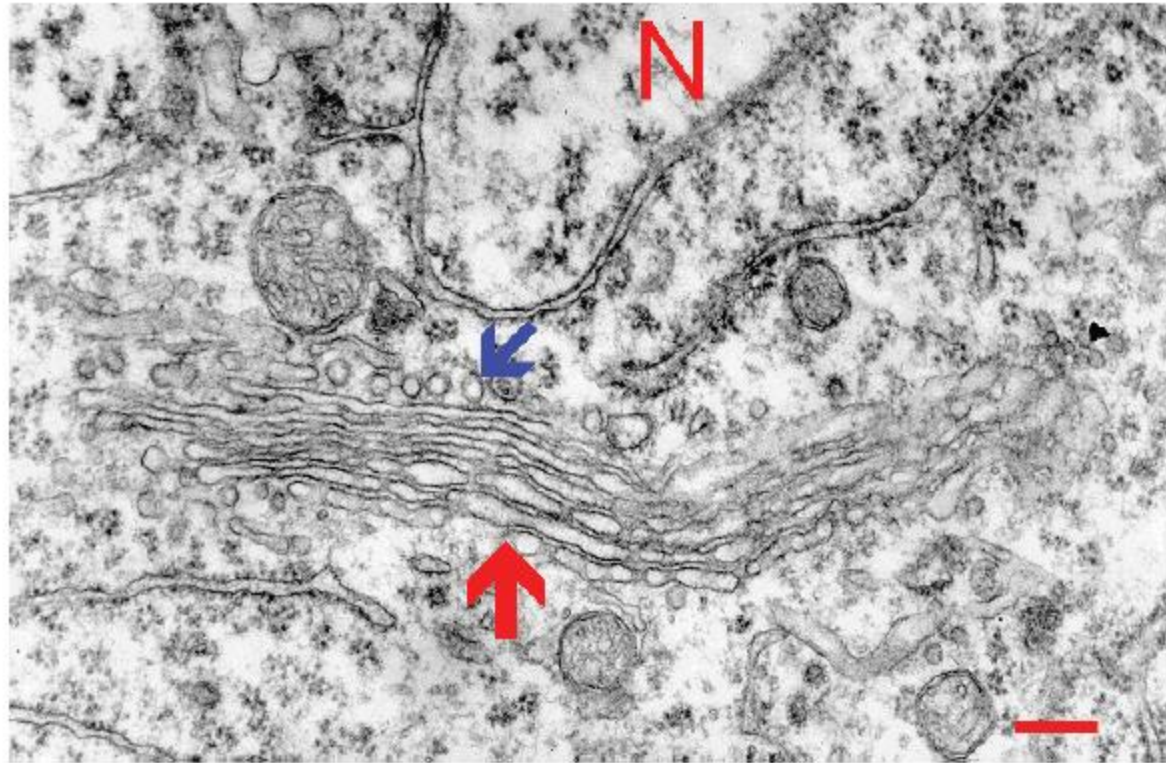

- Sorts, packages, and modifies cargo proteins coming from ER
- Major site of carbohydrate synthesis
- Site of glycosylation and proteoglycan synthesis
- Site of initial aspects of processing of neuropeptides

The Golgi complex is present in the somatodendritic compartment and does not extend into the axon

Differently from neurons, in most eukaryotic cells the Golgi complex is confined to the perinuclear region

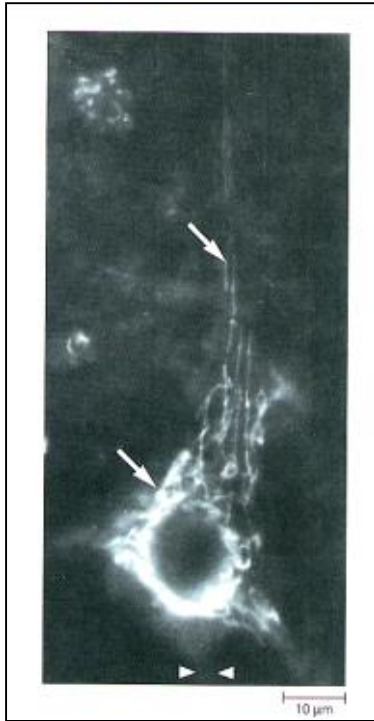

Figure 4-3 Under the light microscope the Golgi complex appears as a network of filaments that extend into dendrites (arrows), but not into the axon. The arrowheads at the bottom indicate the axon hillock. The Golgi complex in this micrograph is in a large neuron of the brain stem immunostained with antibodies specifically directed against this organelle. (From De Camilli et al. 1986.)

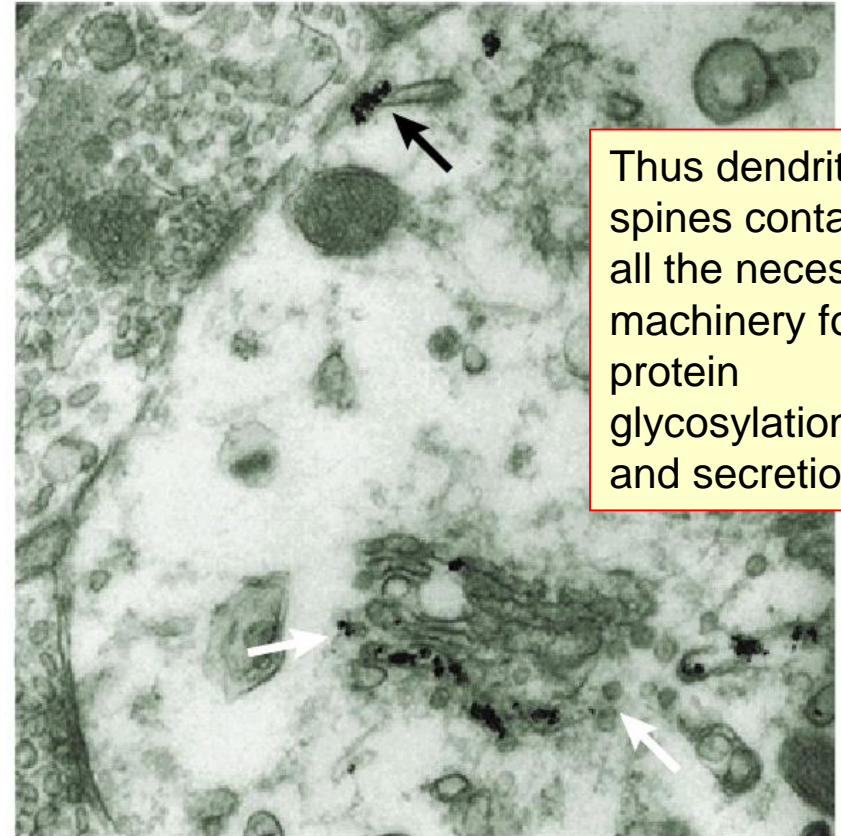

Figure 1 | Electron-microscopic evidence for the existence of Golgi markers in neuronal dendrites. Using gold-labelled antibodies to trans-Golgi network protein TGN38, this Golgi marker can be visualized on the inside of the dendritic spine. White arrows indicate TGN38 immunoreactivity on dendritic stacks; the black arrow highlights TGN38 immunostaining close to synaptic connections. Reproduced with permission from REF. 12 © 1999 Society for Neuroscience.

Neuronal cytoskeleton

Microfilaments

Intermediate
Filaments

Microtubules

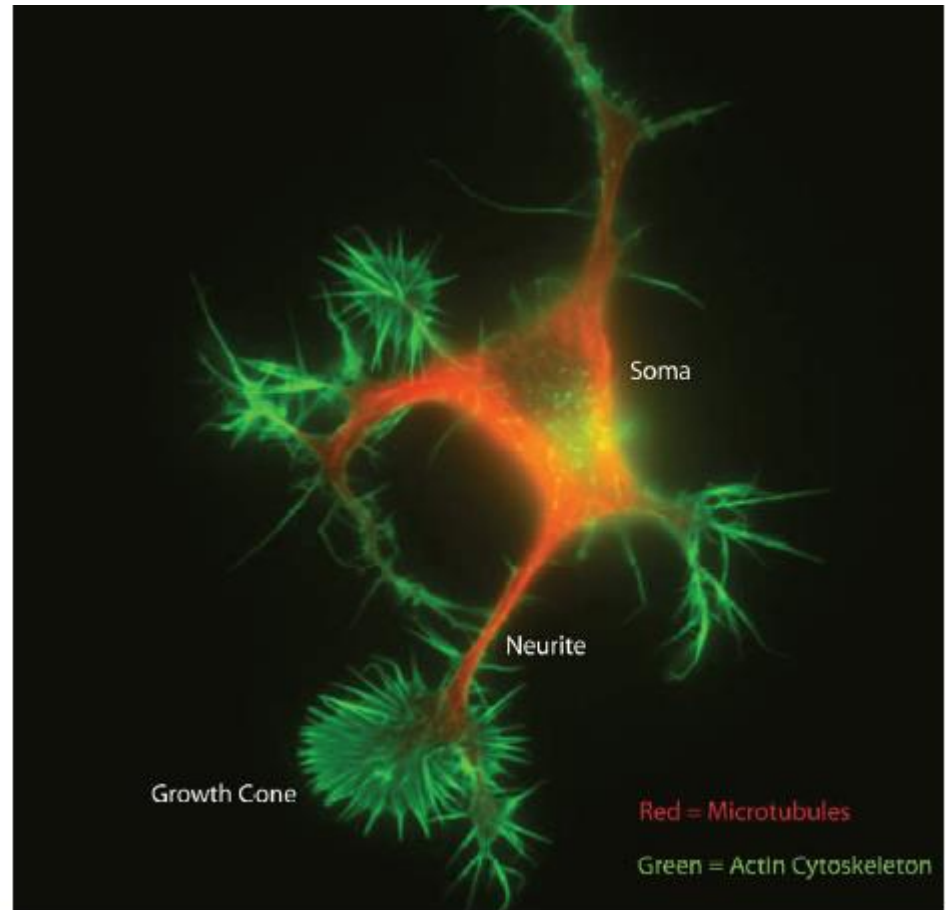

The three types of cytoskeletal filaments have a differential subcellular distribution

Let's have a look to a simple type of polarized cell:
the intestinal epithelial cell

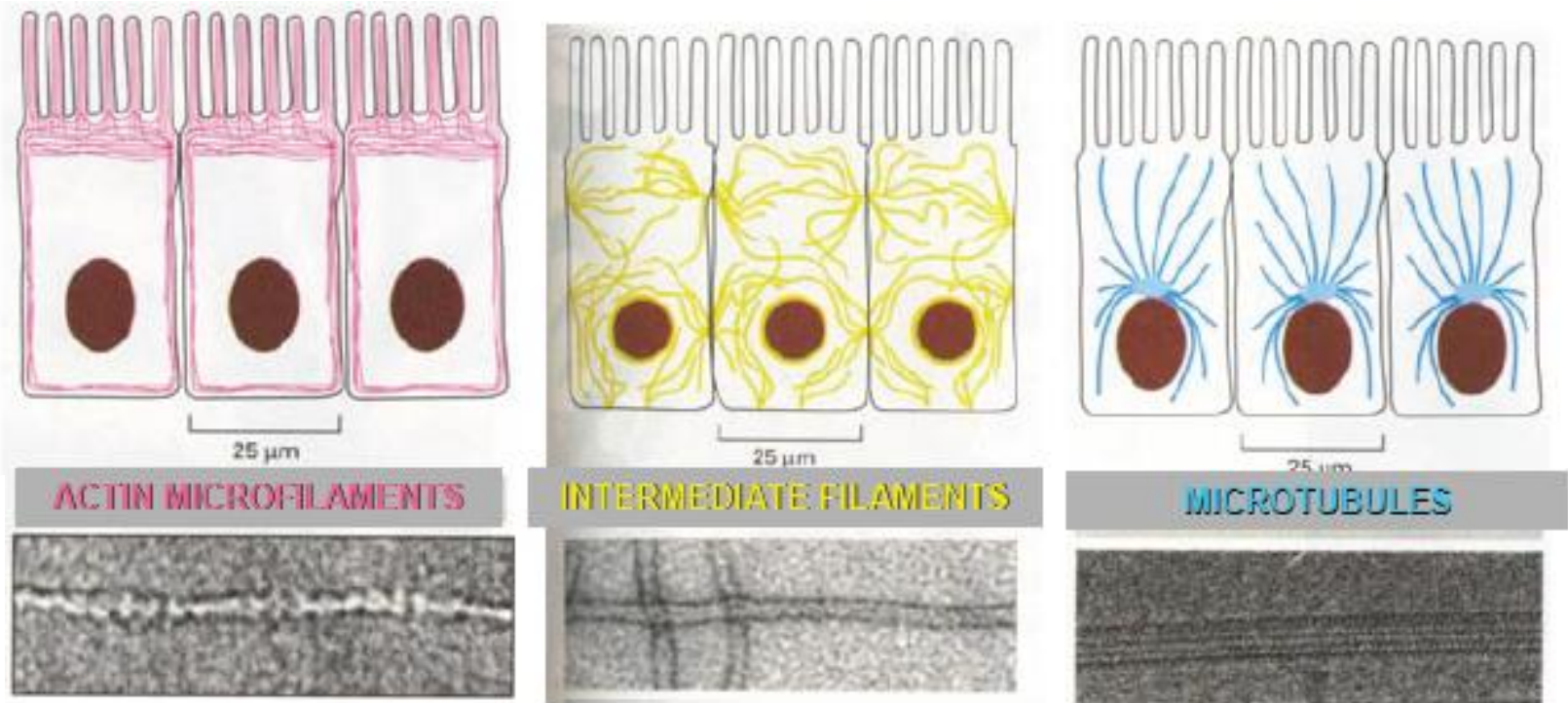

Distribution of neurofilaments and microtubules in the neuron

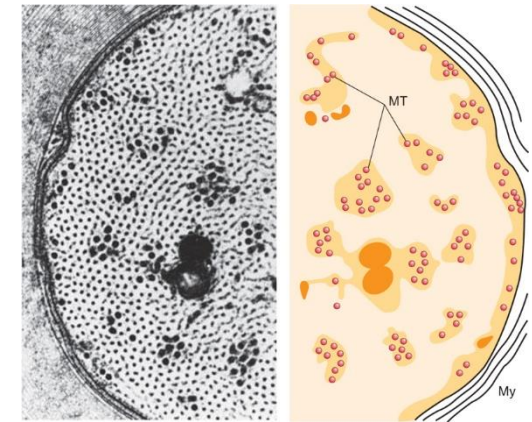
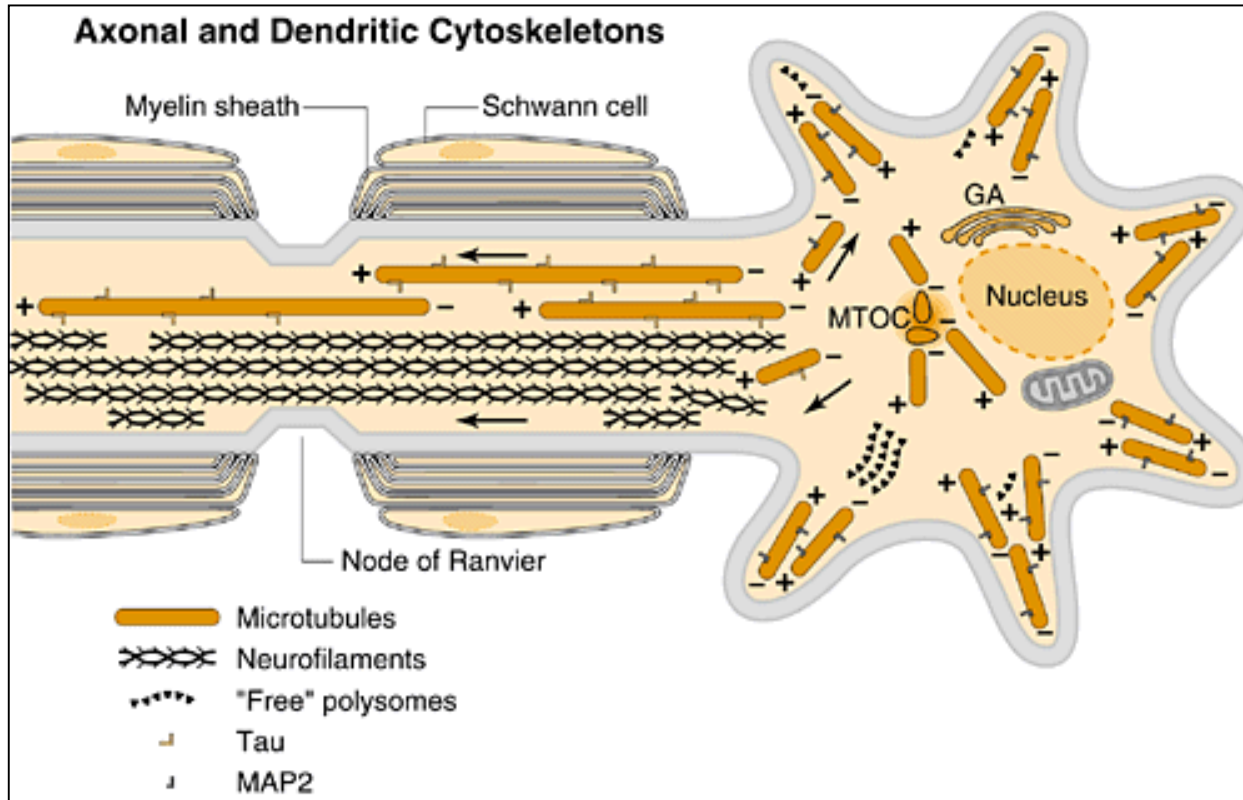

Organization of the cytoskeleton in a cross section of an axon.

Left: Electron micrograph of a myelinated toad axon in crosssection.

Right: Diagram of the same axon. Most of the axonal diameter is taken up by the neurofilaments (*clear area*). The microtubules (*MT*) tend to be found in bundles and are more irregularly spaced. They are surrounded by a fuzzy material that is also visible in the region just below the plasma membrane (*stippled areas, right*). These areas are thought to be enriched in actin microfilaments

Neurofilaments are largely excluded from the dendritic compartment and are highly abundant in large axons.

Microtubules in axons and distal dendrites are unipolar, with the + end pointing away from the cell body. However in proximal dendrites are of mixed polarity.

Intermediate filaments of the nervous system appear as solid, rope-like fibrils from 8 to 12 nm in diameter, they may be many μm long.

TABLE 6-2 IF Proteins of the Nervous System

IF Type	Subunit	Cell type
Type III	Vimentin	Neural and glial precursors
	GFAP	Astrocytes, some Schwann cells
	Peripherin	Subset of neurons, particularly in PNS, may coassemble with NFH/NFM/NFL
	Desmin	Smooth muscle cells in vasculature
Type IV	NFH	Most neurons, most abundant in large neurons
	NFM	
	NFL	
	α -Internexin	
Type V	Nuclear lamins	Nuclear envelope
Type VI	Nestin	Neuroectodermal precursors in developing brain

Intermediate Filaments – no polarity

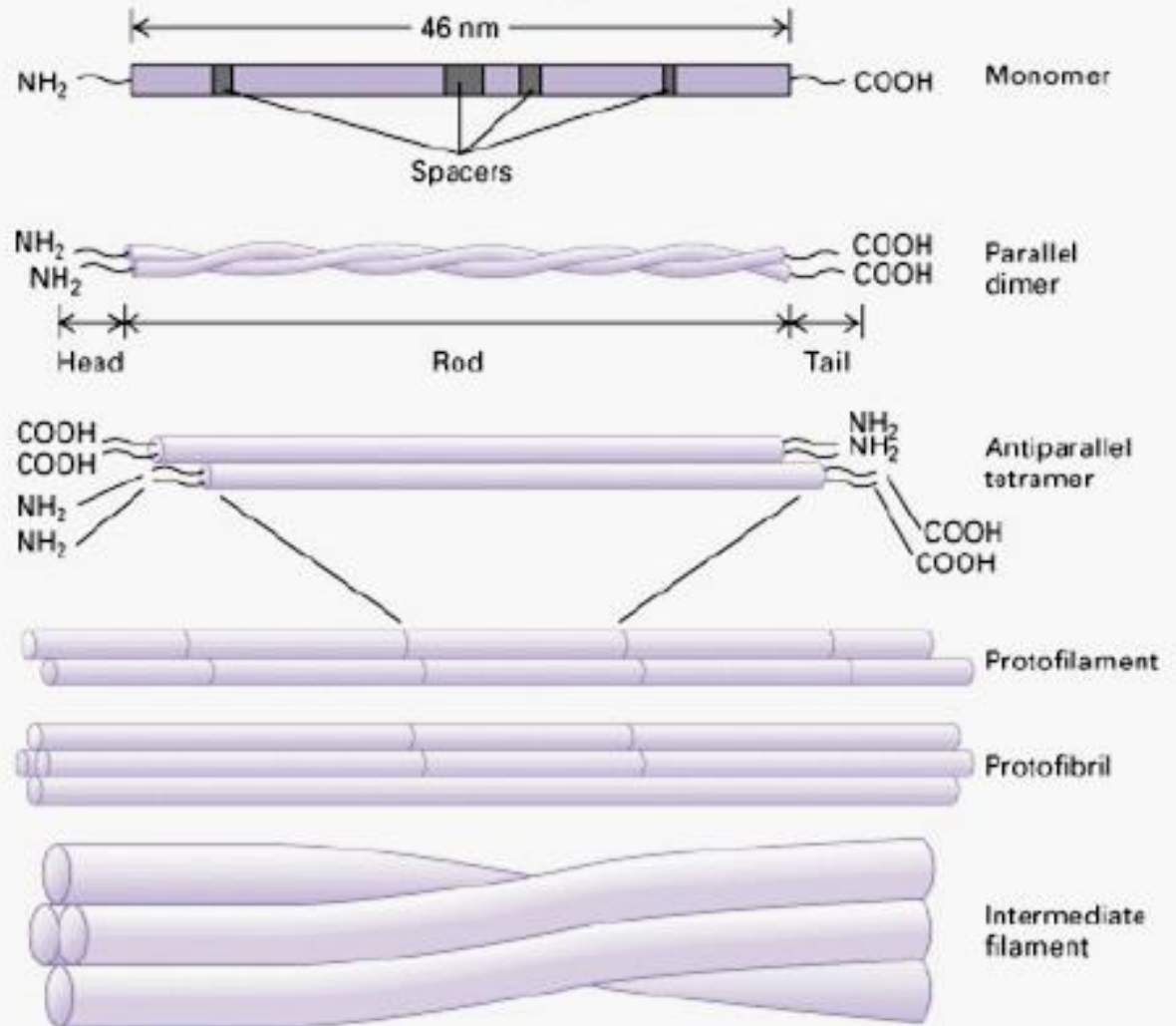

Neurofilaments have an unusual degree of **metabolic stability**, with a special role in stabilizing and maintaining neuronal morphology

Mutations in neurofilament genes are associated with some neuropathologies

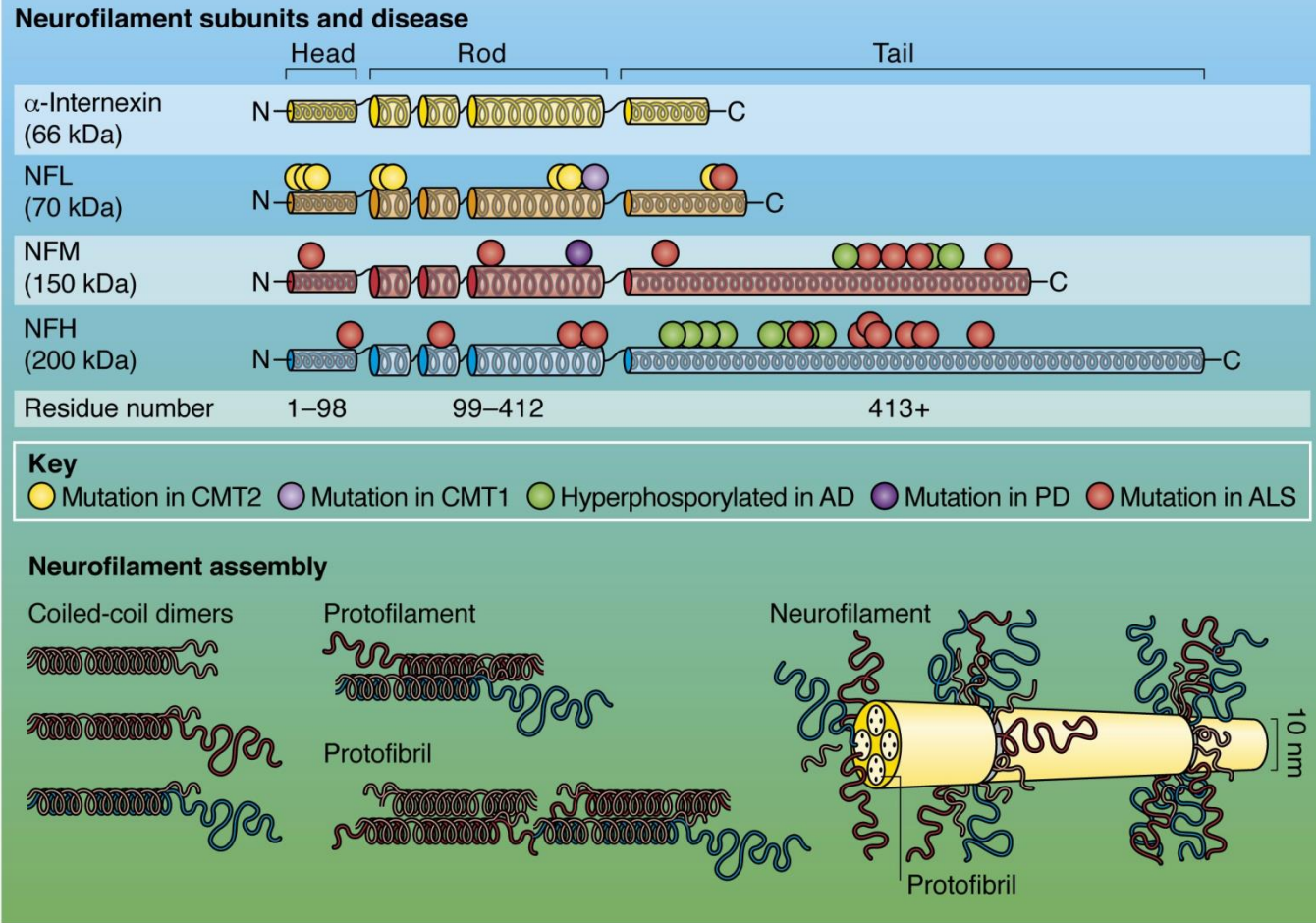
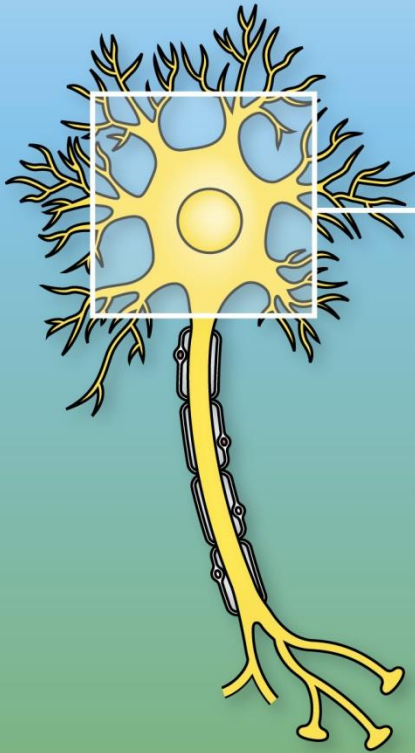

IF in neurons are formed by 3 subunits, the **neurofilament triplet**, each encoded by a separate gene

CMT = Charcot Marie-Tooth disease

Tangles or aggregates of NFs are often associated with neurodegenerative diseases

Comparison of IF in neurons and glia

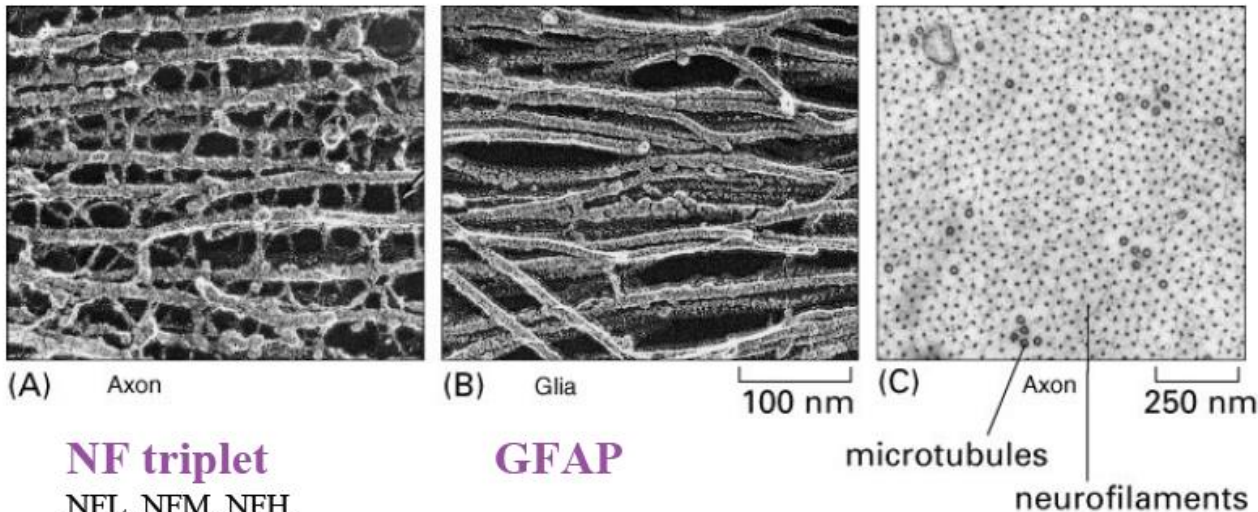

NF triplet
NFL, NFM, NFH

GFAP

microtubules
neurofilaments

IF in neurons (NFs):

- Represent 13% of total protein in mature neurons
- Neurofilament composed of NF-L, -M, and -H
- NF-L required for all filament assembly
- Side arms of NFM & NFH contribute to wider spacing of NFs relative to glial IFs
- The side arms of NFH & NFM have consensus phosphorylation sites.
Phosphorylated side arms repel adjacent NFs with similar charge

IF in glia (or other non-neuronal cells):

- are shorter and lack side-arms

The local environment can alter the organization of the axonal cytoskeleton

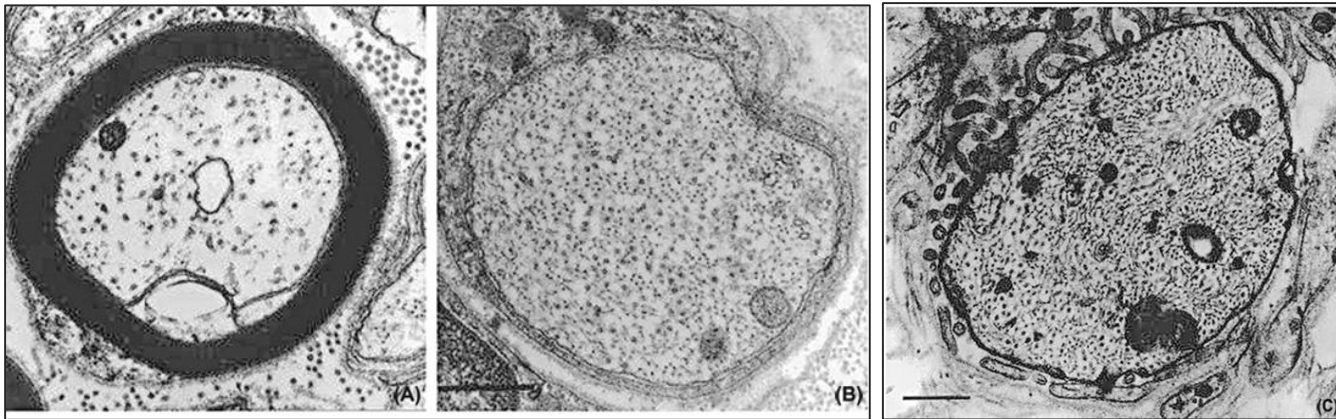

(A) In a normal myelinated axon of the sciatic nerve, neurofilaments and microtubules are widely spaced, so they occupy considerable volume. **(B)** In contrast, a comparably sized axon from the sciatic nerve of the **demyelinating Trembler mutant mouse** has a denser cytoplasm, with neurofilaments densely packed. This has been shown to result from a shift in the net **dephosphorylation of neurofilaments produced by demyelination**. This effect on the axonal cytoskeleton is highly localized. **(C)** Similar changes in the organization and phosphorylation of the axonal cytoskeleton occur even over the short gap in the myelin sheath which occurs at the **node of Ranvier**. Such changes illustrate the dynamic nature of the axonal cytoskeleton. Bars represent 0.5 μm with **(A)** and **(B)** at the same magnification. (Micrographs supplied by Sylvie de Waegh and Scott Brady.)

Microfilaments

- Smaller very dynamic structural filaments
- Composed of actin polymers
- Involved in cell motility and axon growth via filopodia and lamellipodia
- Involved in endocytosis and intracellular motility
- Structurally component of neuronal spines
- Act with myosins to drive certain intracellular movements
- Synapse structure

ACTIN

Cell/ Growth Cone Migration

Sensing and Processing Environmental Cues

Microfilament

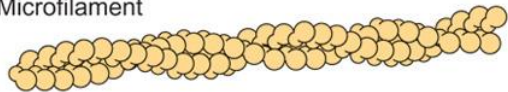

<http://cellix.imba.oeaw.ac.at/cytoskeleton>

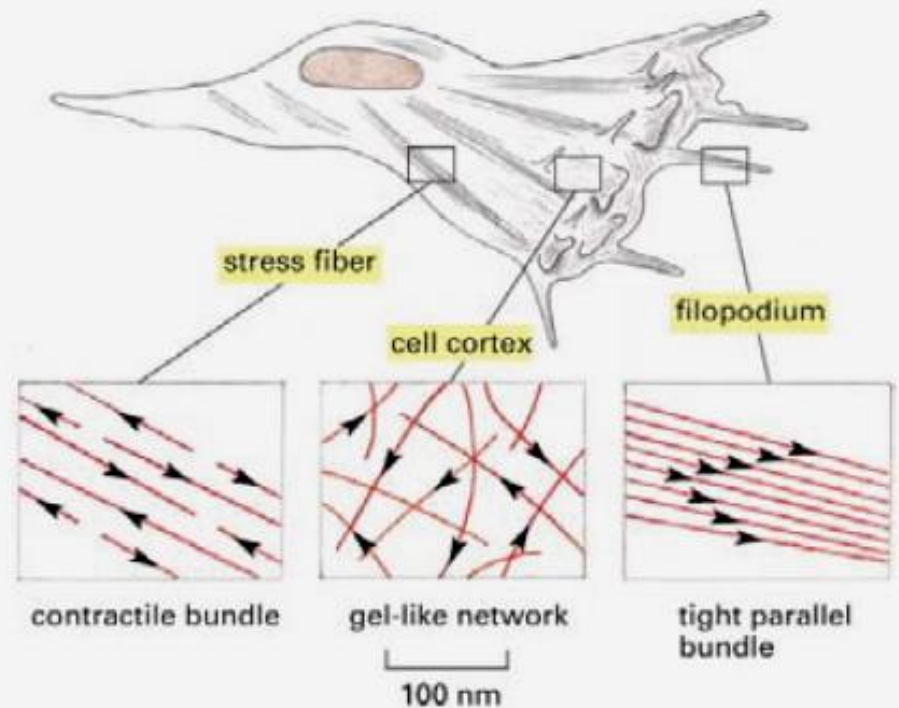

Figure 16-38. Molecular Biology of the Cell, 4th Edition.

Actin is Enriched in Lamella and Growth Cones

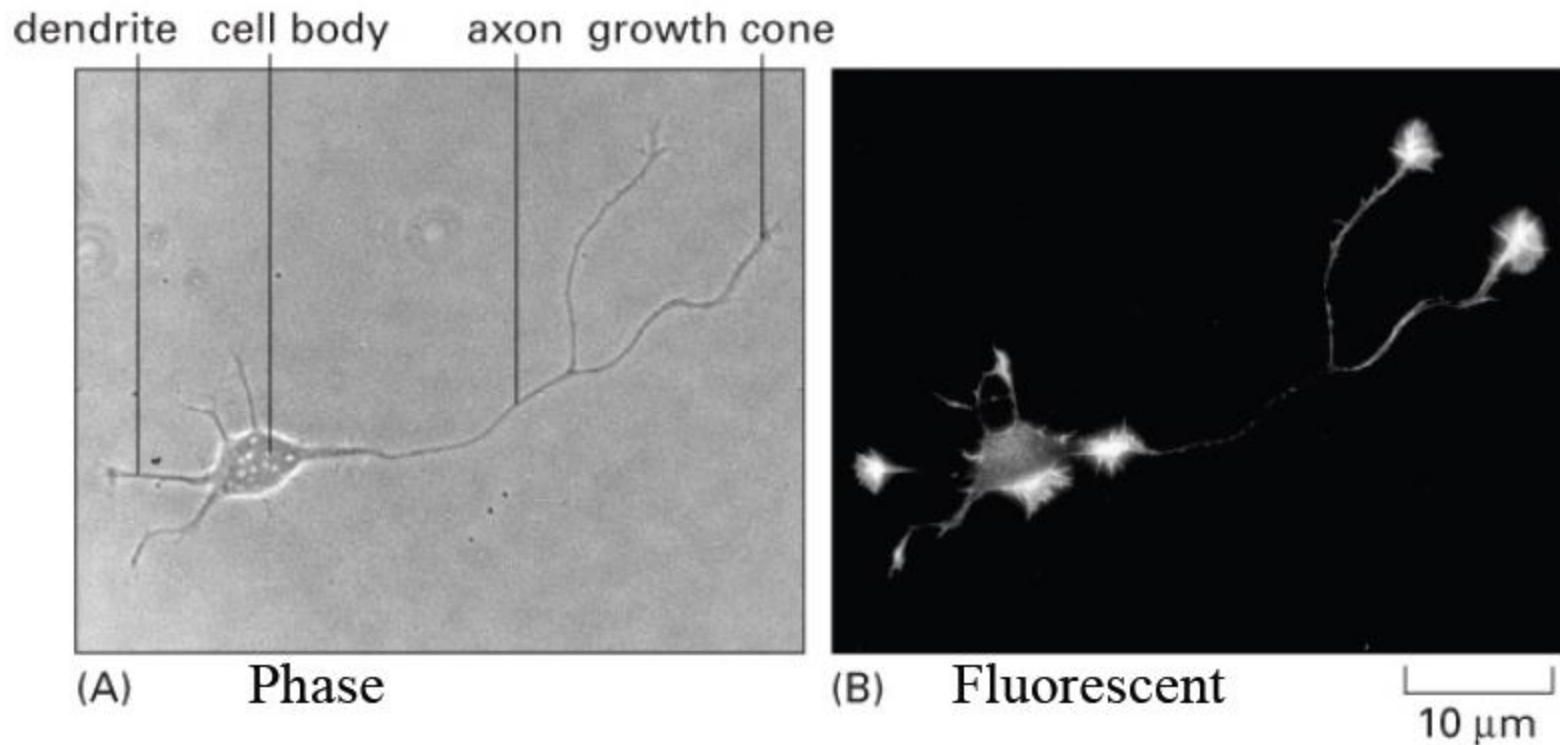
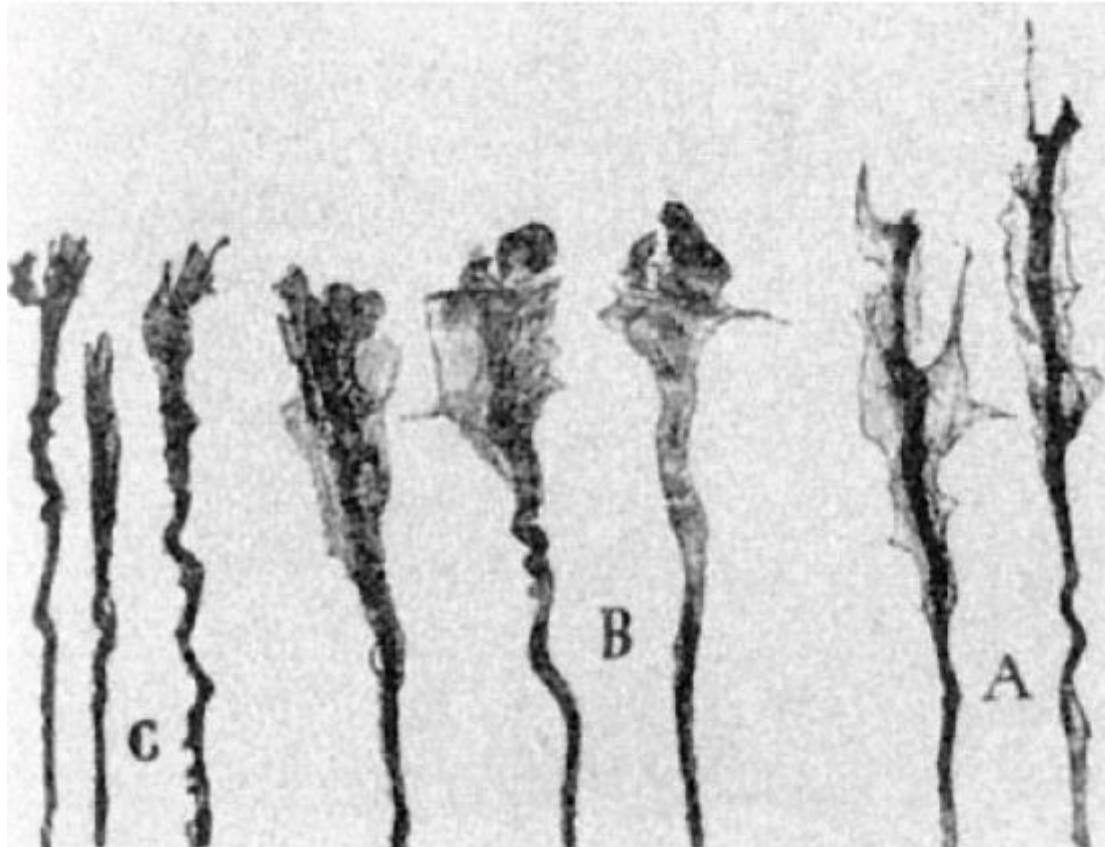

Figure 21-97. Molecular Biology of the Cell, 4th Edition.



Growth Cones

Mammalian from RyC

Growth cones sample the environment and respond to signaling cues.

The end results of the signaling pathways are changes in actin and MT cytoskeletal dynamics.

Growth Cone of Aplysia Bag Cell Neuron

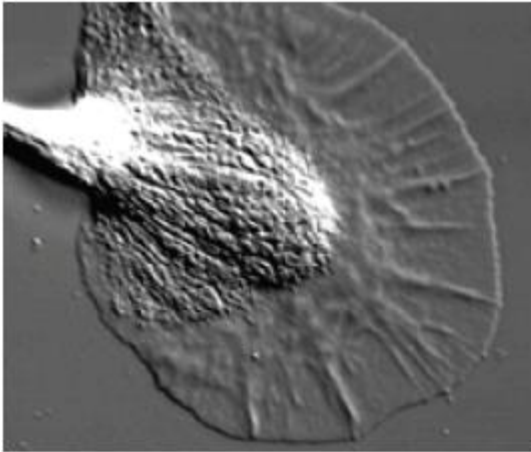

These mollusc neurons are great for growth cone studies. Big and flat, note a peripheral (P) region with actin but relatively empty and the vesicle filled central (C) region (with mts). MTs concentrated in the central region, but some in P region

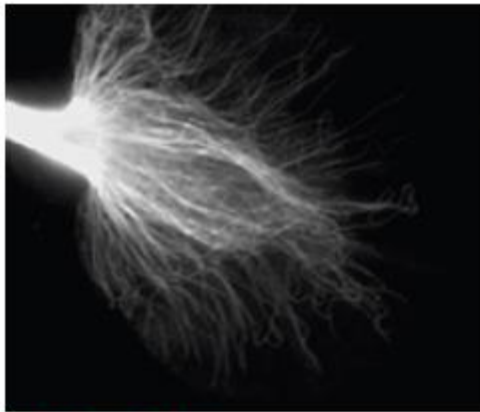

Tubulin

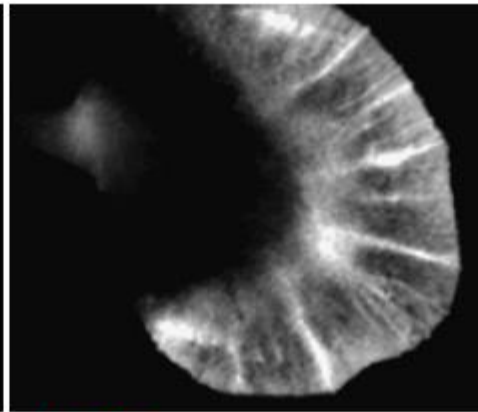

Actin

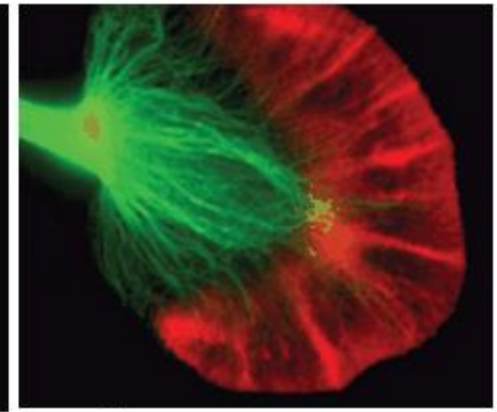

Both

The neuronal actin cytoskeleton

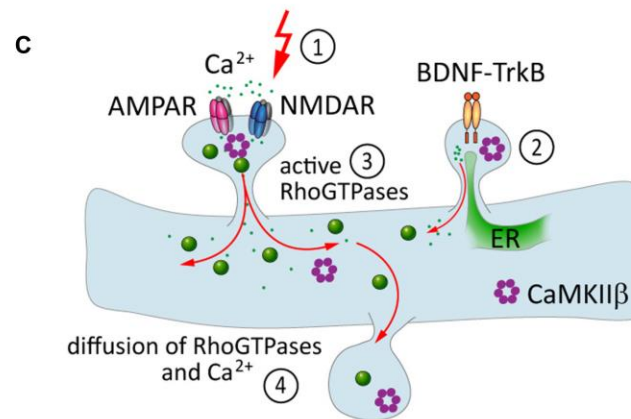
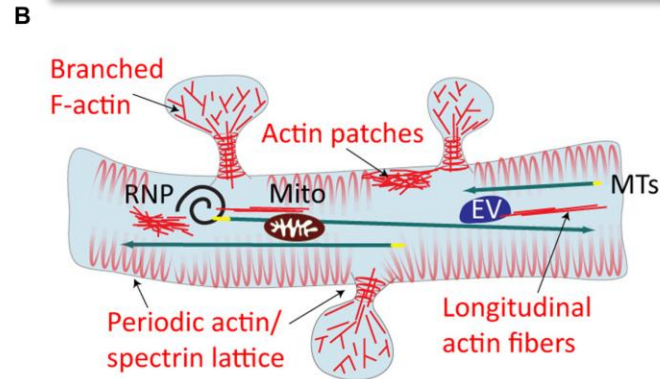
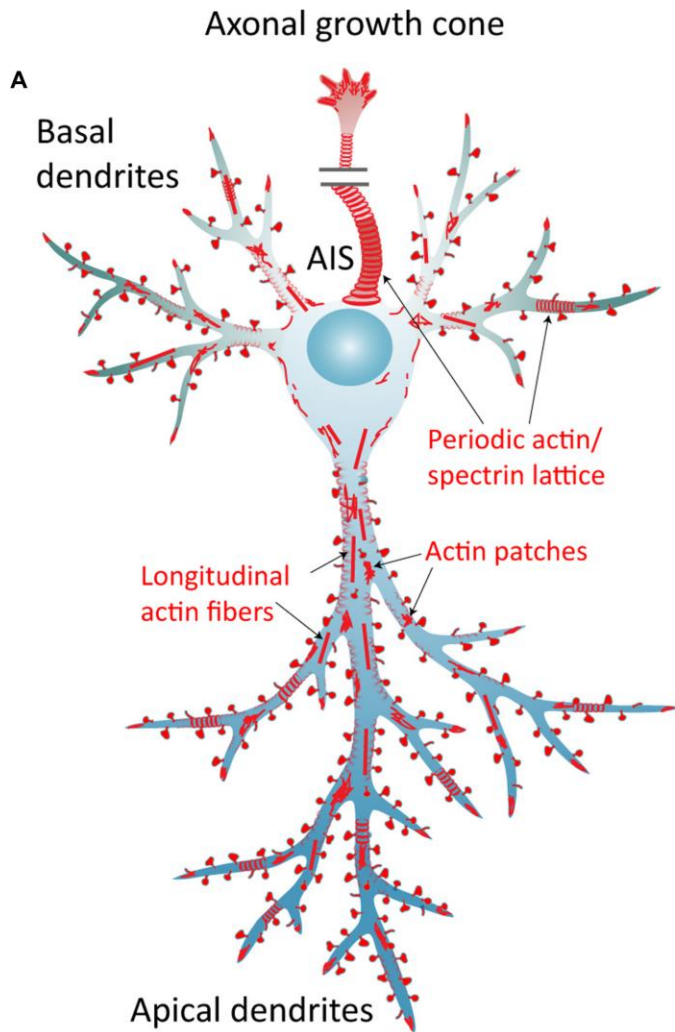

Konietzny et al., 2017
Frontiers in Cellular Neurosci.
doi: 10.3389/fncel.2017.00147

RE 1 | The neuronal actin cytoskeleton and its regulation by external factors. (A) Overview of different actin structures present in pyramidal neurons: F-actin enrichments called actin patches, longitudinal actin fibers, and a cortical periodic actin/spectrin lattice termed “actin rings” can be found throughout and in dendrites. (B) Dendritic spines contain branched F-actin in the head, and straight bundles as well as a periodic actin/spectrin lattice in the neck. Directed sort of cargo from the soma to the dendrite is carried out via MTs, and can then be subjected to activity-dependent positioning at the base of activated spines F-actin and myosin-dependent manner. EV = endosomal vesicle, RNP = ribonucleoprotein, Mito = mitochondrion. (C) Dynamics of the dendritic actin cytoskeleton are influenced by external cues. Those include the transduction of external signals to the actin cytoskeleton via cell-surface receptors that couple to GEFs or ABPs, and Ca²⁺ signaling. The latter involves Ca²⁺ influx through glutamate receptors following synaptic stimulation (1), and Ca²⁺ release from internal stores, triggered for instance by BDNF-TrkB-signaling (2). Both pathways include the activation of Rho-GTPases (3), which act as “molecular switches” that regulate a multitude of cellular functions. Diffusible factors, like Ca²⁺, Rho-GTPases, CaMKIIβ and other downstream effectors, can spread the signal from their activation site to the dendrite and to other spines (4). ER = endoplasmic reticulum.

TABLE 6-3 Selected Microfilament-Associated Proteins Expressed in the Nervous System

Protein	Activity	Cellular location
Actin	Core subunit of MFs	Throughout neurons and glia, enriched in growth cones and in membrane cytoskeleton
Tropomyosin	Stabilize MFs	Co-distributed with most MFs
Spectrin/fodrin	Cross-link MFs in membrane cytoskeleton	Enriched in membrane cytoskeleton
Ankyrin	Links MF/spectrin to membrane proteins	Membrane cytoskeleton, distinct forms in axon, dendrite and nodes of Ranvier
Fimbrin	MF bundling and cross-linking	Growing neurites
Gelsolin	Fragments MFs and nucleates assembly, regulated by Ca ²⁺	Growing neurites, glia, mature neurons
β -thymosin	Binds actin monomers and regulates MF assembly	Growing neurites
Profilin	Binds actin monomers, inhibits MF formation, regulated by selected signal transduction pathways	Growing neurites, glia, mature neurons
Arp2/3	Nucleation of actin MF assembly in cortex and initiation of MF branches	Enriched in cell cortex where MF assembly is active
N-WASP	Interacts with Arp2/3 complex to nucleate branched actin MF assembly	Enriched in cell cortex where MF assembly is active, binds to Cdc42/Rac small GTPases and Arp2/3 complexes
Formin	Nucleates straight actin filaments	Enriched in cell cortex where MF assembly is active, binds to Rho small GTPase

Microtubules

- **Are the tracks or highways for organelle transport**
- **Maintain elongated (asymmetric) neurite process morphology**
- **Different polarity distribution in axons and dendrites**
- **Microtubule associated proteins (MAPs) contribute to function**
Structural MAPs also different in axons and dendrites
Motor Proteins are also MAPs

Axons and Dendrites: Different Microtubule Associated Proteins (MAPs)

Two MAPs (structural):

Red: MAP2 in the soma and dendrites

Green: Tau (dephosphorylated) in the
axon

Cultured hippocampal neuron

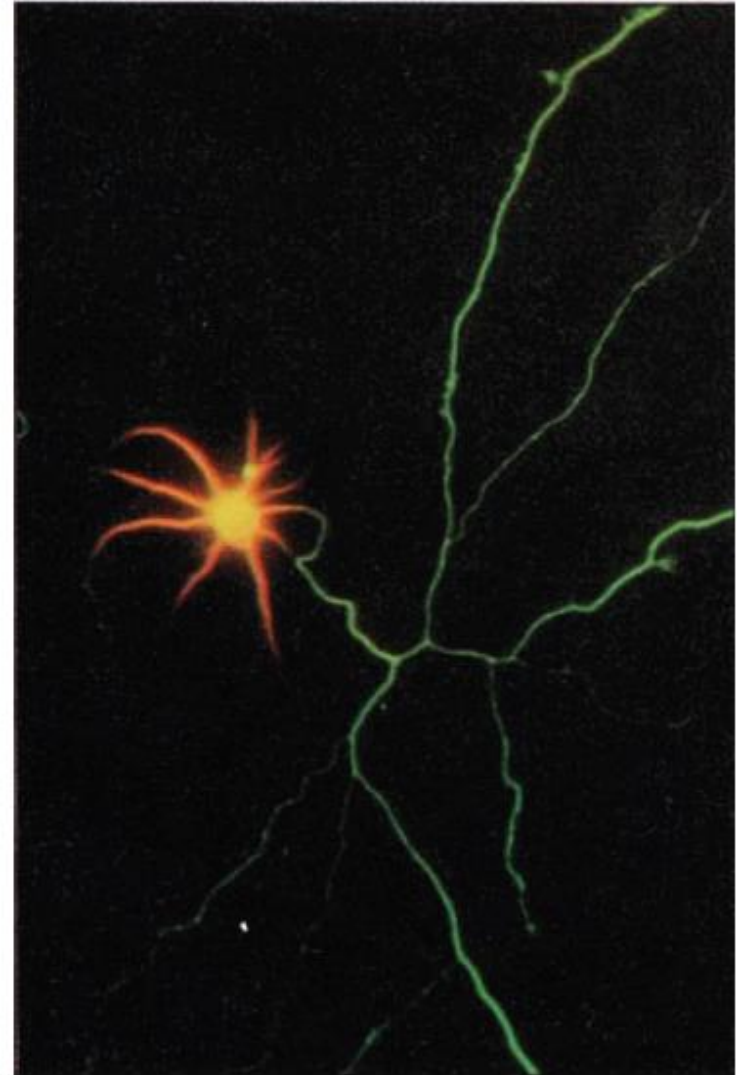

Role of MAPs and other MT regulators

Organize microtubules in neurons

Bundle microtubules (assembly MAPs, MAP1A and MAP1B)

Stabilize microtubules (MAP2, MAP4, Tau, acetylation of MTs)

Control rate of tubulin polymerization
(phosphorylated MAPs cannot bind to MTs)

Microtubule severing proteins (spastin and katanin)

Microtubule-actin linking proteins (spectraplakins)

Microtubule organization in axons and dendrites

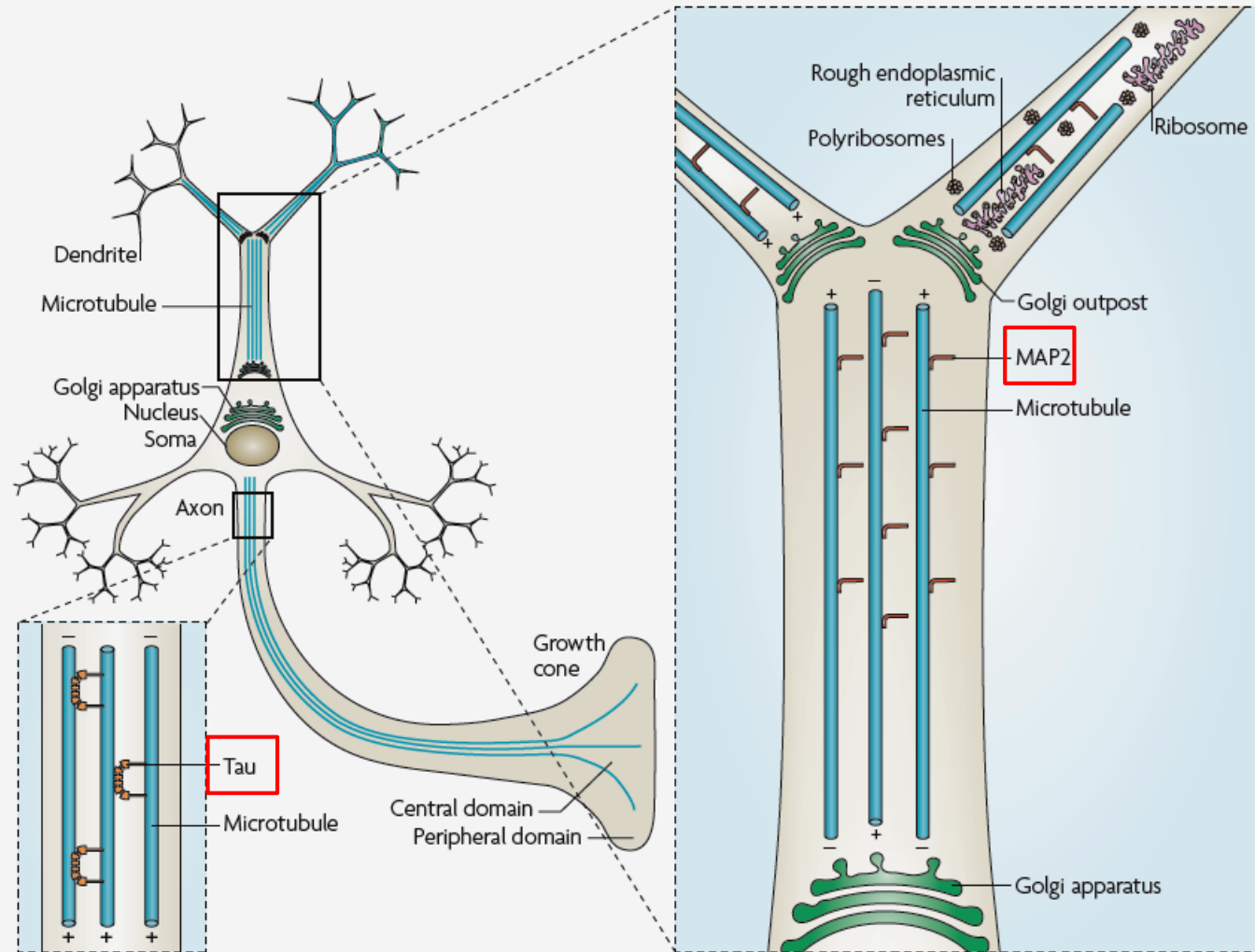
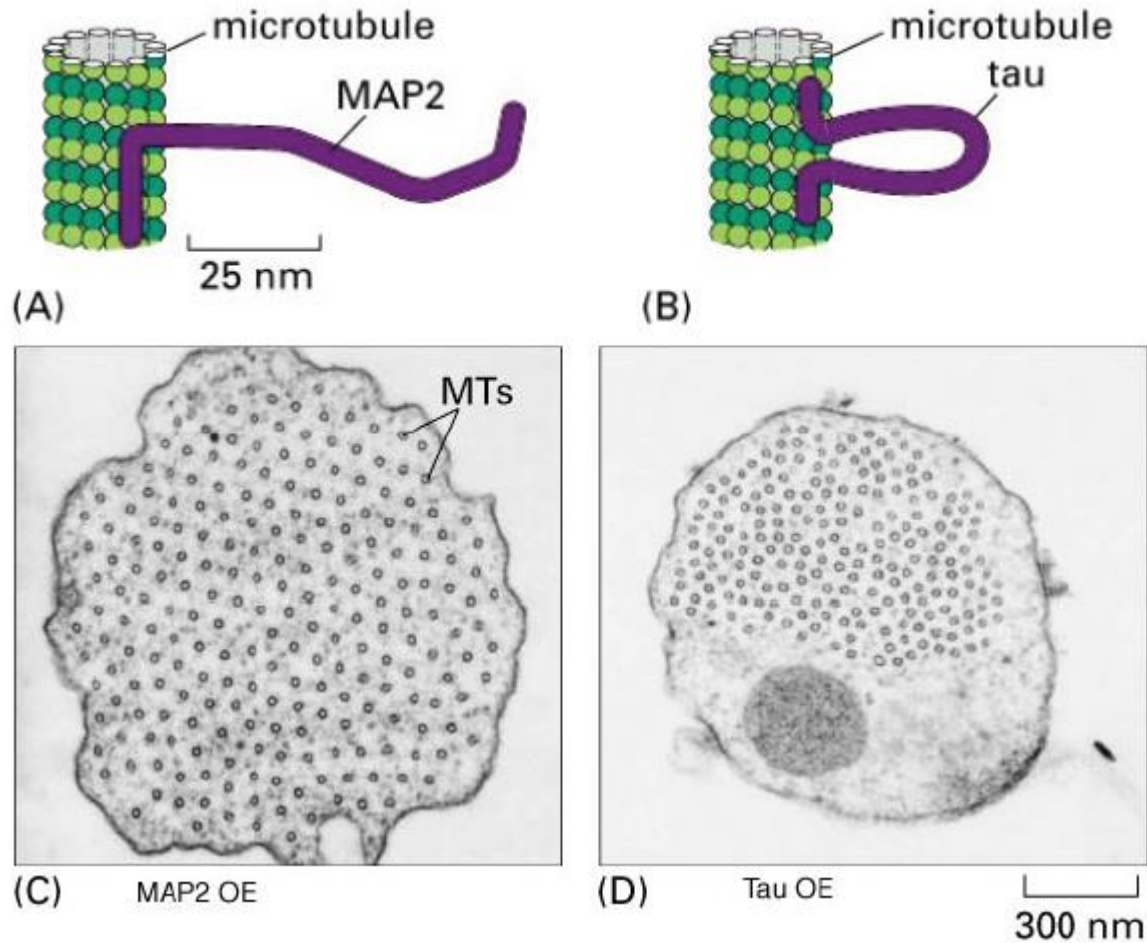

Figure 1 | **Microtubule organization and organelle distribution in axons and dendrites.** Axons have tau-bound microtubules of uniform orientation, whereas dendrites have microtubule-associated protein 2 (MAP2)-bound microtubules of mixed orientation. Dendrites also contain organelles that are not found in axons, such as rough endoplasmic reticulum, polyribosomes and Golgi outposts.

MAP2 and tau bind to MTs

The lengths of their side arms may contribute to spacing of mts.



Microtubules are tracks for **axonal transport**

Axonal Transport

Axons can be >95%
of total neuronal volume.

All proteins in the axon are
made in cell body and must be
transported into and along the
axon

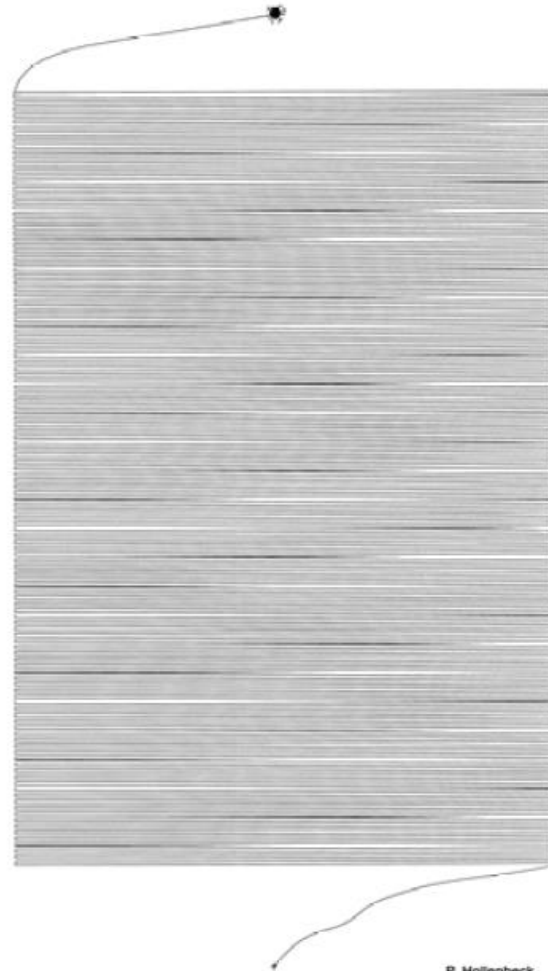

How do we study axonal transport?

- ❑ Metabolic cell-labeling experiments in the 1960s demonstrated the rapid movement of newly synthesized proteins along the axon in a process termed “**cellulifugal transport**” (Weiss, 1967).
- ❑ Experiments with drugs that disrupt the cellular cytoskeleton demonstrated that **microtubules are required** for active transport along the axon (Kreutzberg, 1969).
- ❑ Pulse-chase labeling experiments led to the discovery of multiple phases of transport. Organelles were observed to move outward from the cell body at “**fast**” speeds of up to 400 mm/day, while cytoskeletal proteins and some soluble proteins were observed to move via “**slow**” transport, at speeds of <8 mm/day.
- ❑ The development of **live-cell imaging** allowed the direct observation of organelle motility (Allen et al., 1982; Brady et al., 1982). These observations led to the discovery of the microtubule motor **kinesin**, now known as kinesin-1; **cytoplasmic dynein** was discovered soon after.

Fast Axonal Transport

Extrusion of Axoplasm from squid giant axon

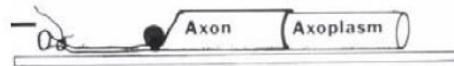

Video microscopy reveals that organelle movement can continue in apparently normal fashion in axons isolated from their cell bodies and divested of a cell membrane. The implication is that transport must be driven by **local energy-generating mechanisms**

<https://www.youtube.com/watch?v=i3hxq4XPez0>

Fast axonal transport

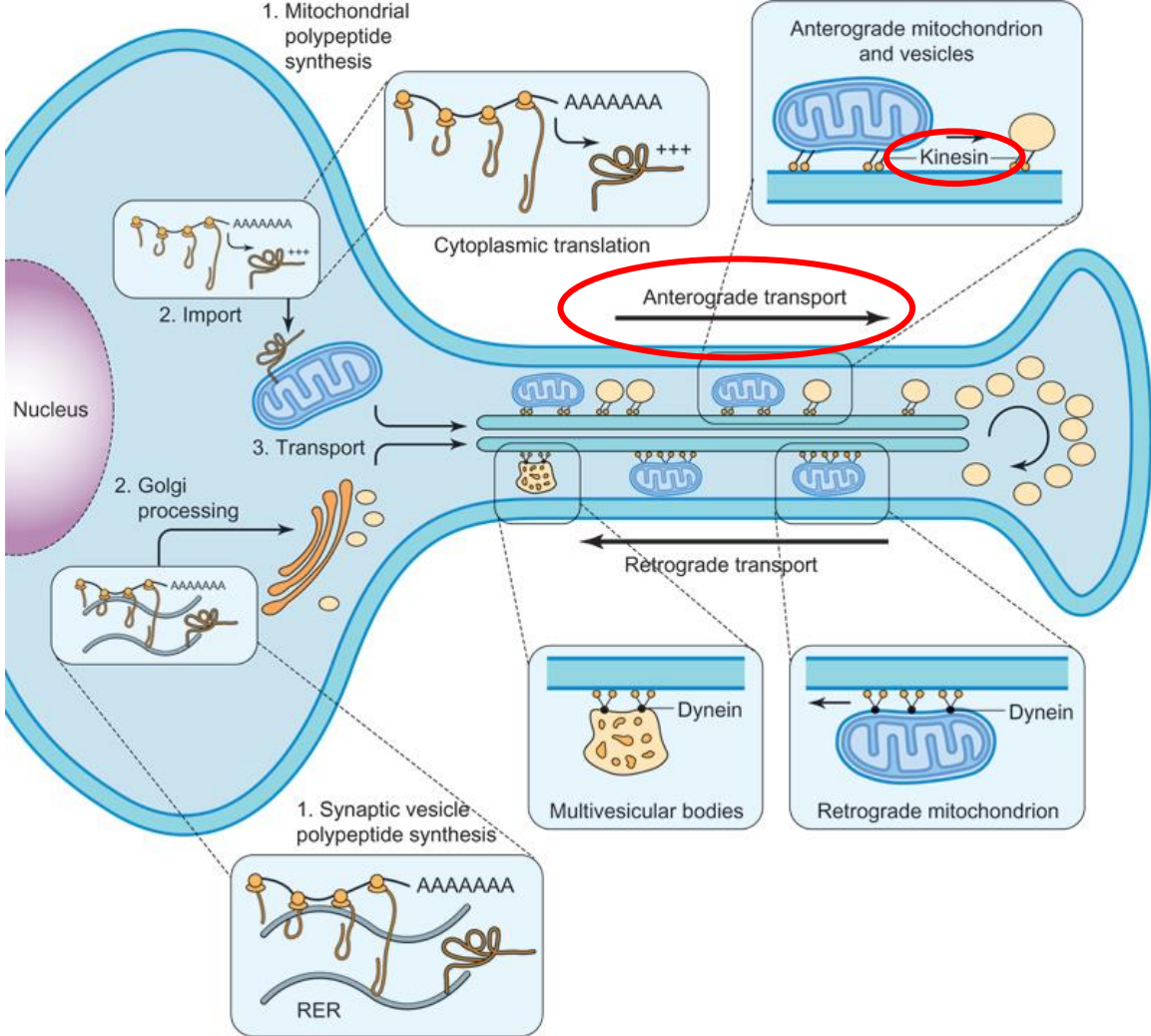

100-400 mm/day

Membranous organelles

**ANTEROGRADE
&
RETROGRADE**

Slow axonal transport

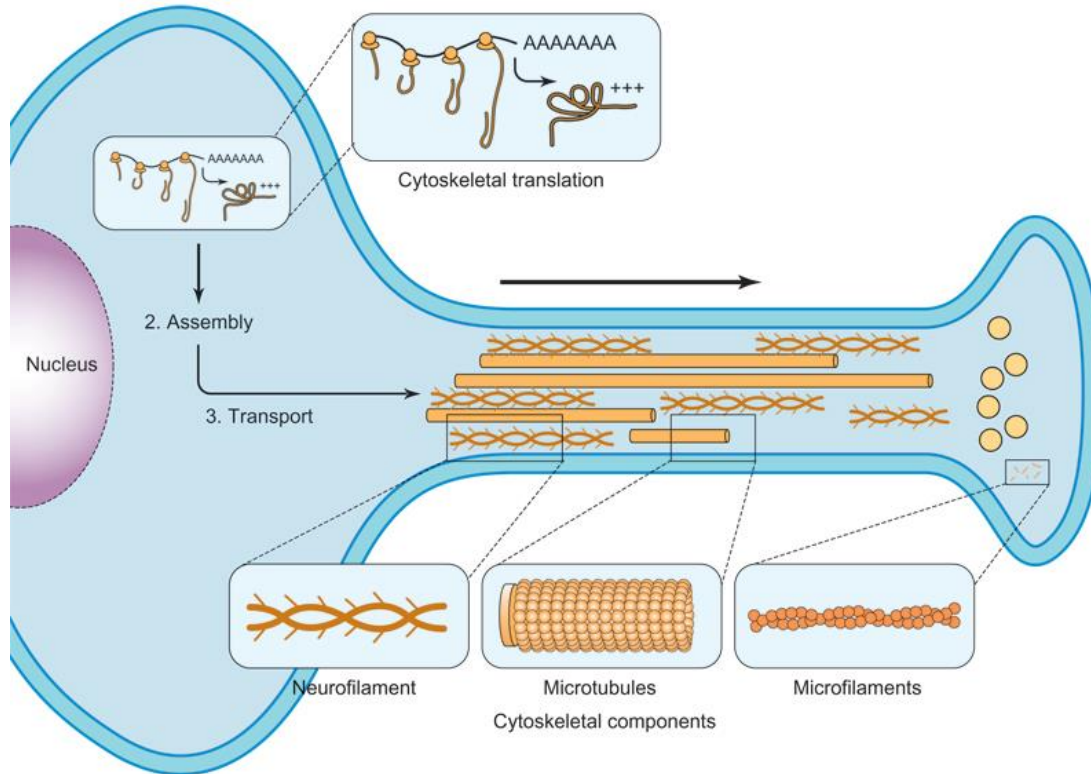

~ 0.2-2.5 mm/day

Cytosolic and cytoskeletal proteins

Roles of axonal transport:

ANTEROGRADE

- Establishing neuronal polarity
- Deliver growth and guidance molecules to the growth cone
- Deliver synaptic components
- Deliver cytoskeletal construction along the axon
- Neurotrophin transport
- Energy supply - mitochondrial transport
- Transport of mRNA

RETROGRADE

- Growth factor signaling
- Injury signaling
- Neurotoxin / viral transport
- Energy supply - mitochondrial transport

Molecular Mechanisms of Axonal Transport

Microtubule motor proteins **kinesin** and **dynein** drive the movement of organelles, vesicles, RNA granules, and proteins along the axon. Kinesins drive **anterograde** transport outward from the soma, and dynein drives **retrograde** transport back from distal axon. To avoid either distal accumulation or distal depletion of cellular components, anterograde and retrograde axonal transport must be in balance.

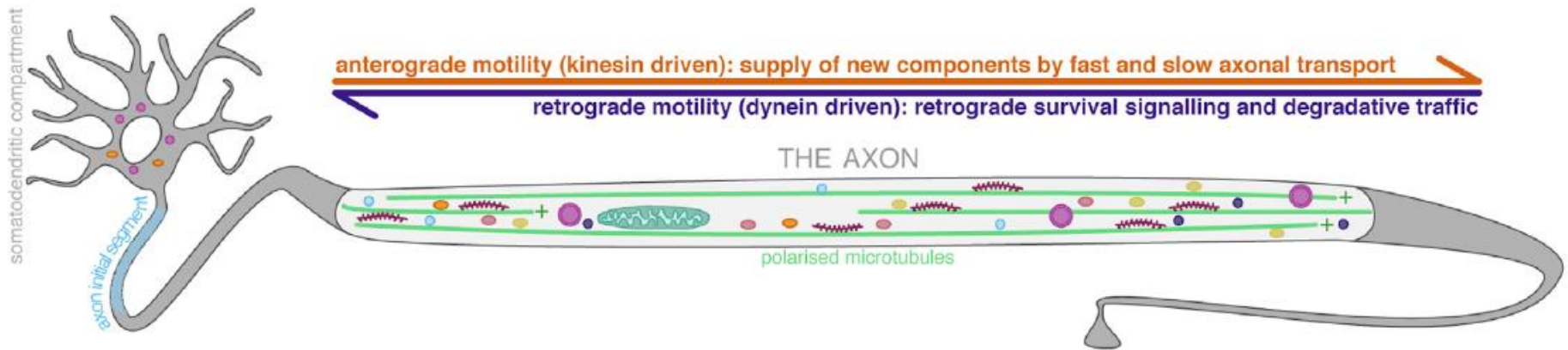

Kinesins: motor, stalk and cargo binding

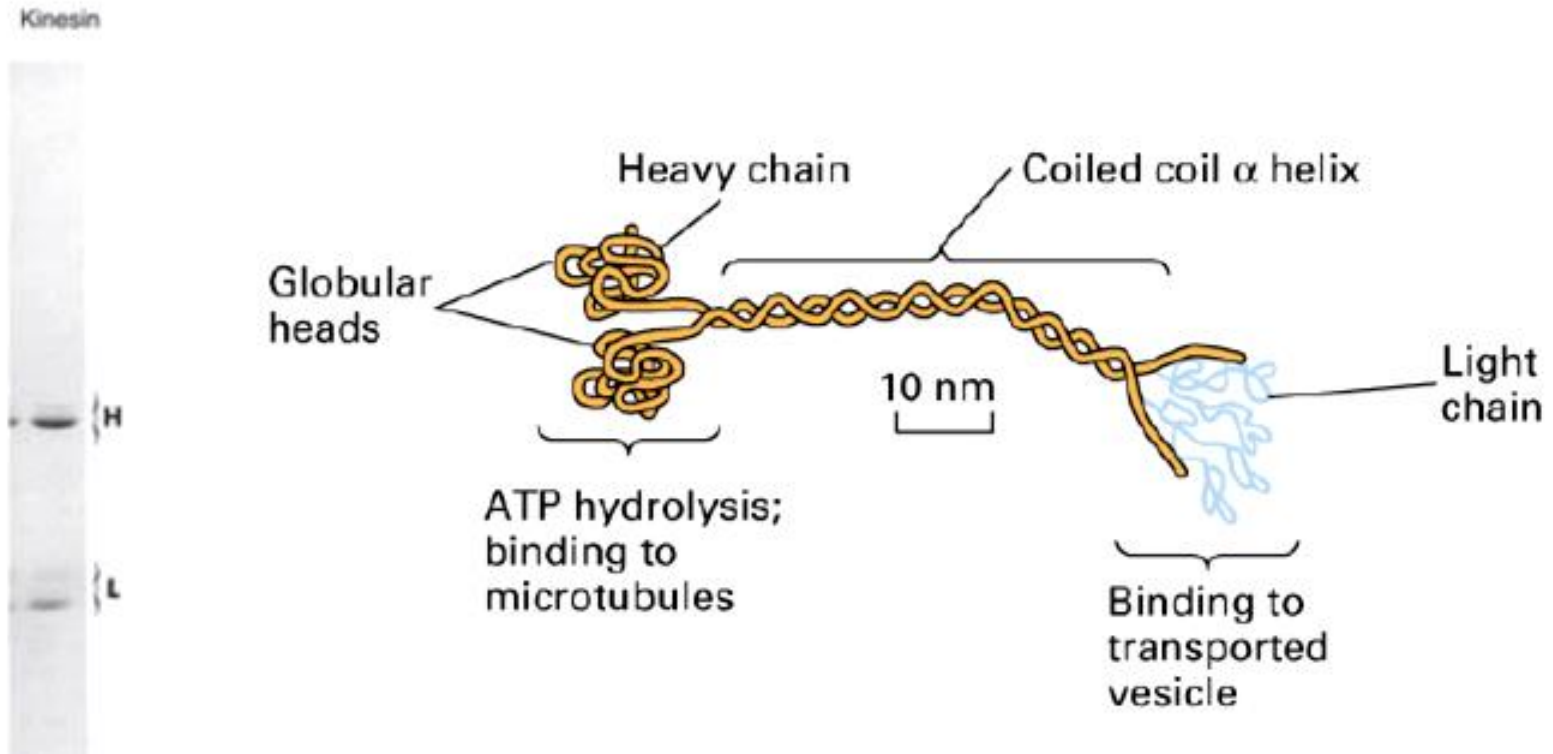

The autoinhibition of kinesin-1 is key to its regulation. **The binding of kinesin tail to the motor domain blocks motor function**; inhibition is relieved by specific binding partners such as the scaffolding proteins **JIP1 and JIP3**

The structure and phylogeny of major mouse kinesins

The kinesin superfamily constitutes **45 genes** in the mammalian genome, 38 of which are expressed in brain.

Kinesin genes can be grouped into **14 subfamilies** that share structural and functional similarities; motors from the kinesin-1, kinesin-2, and kinesin-3 families all contribute to axonal transport dynamics.

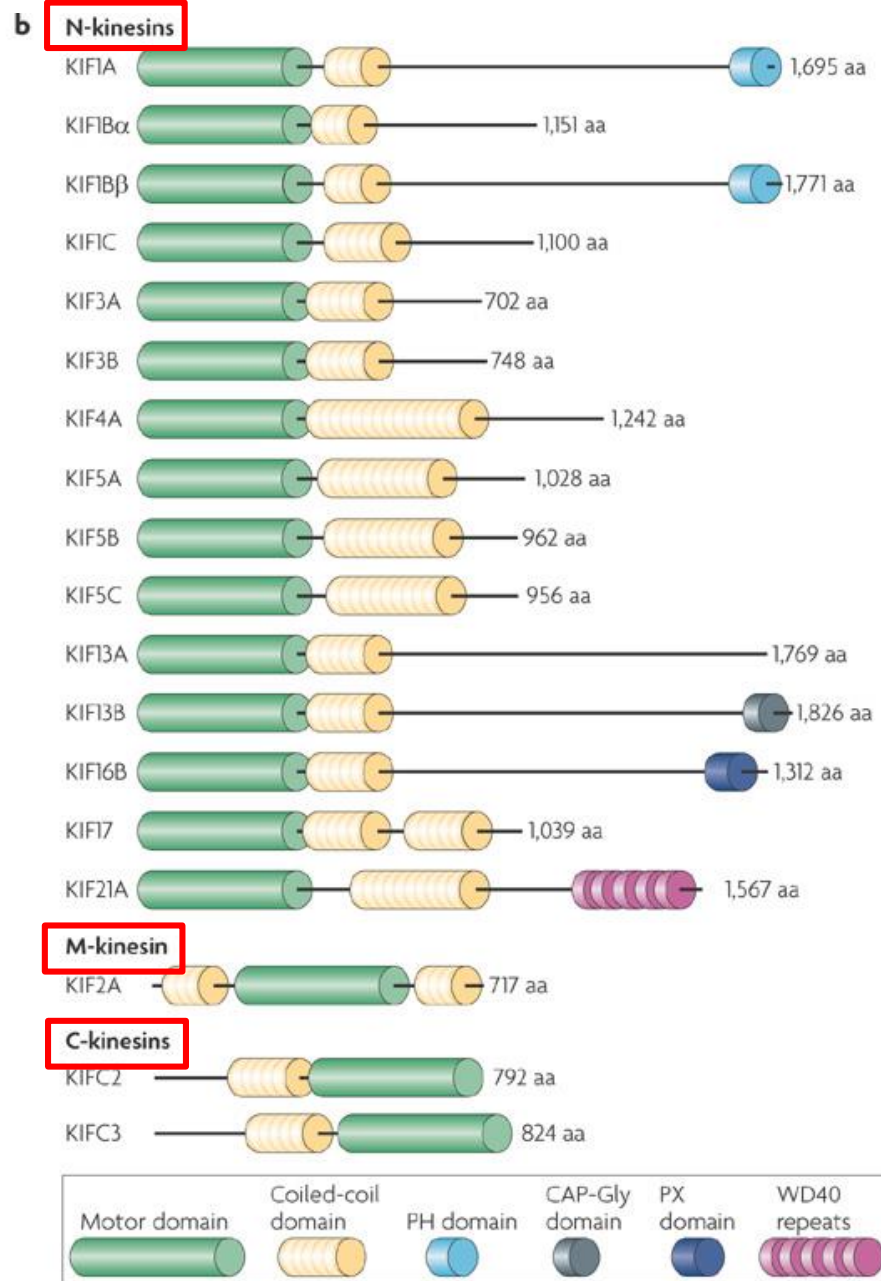
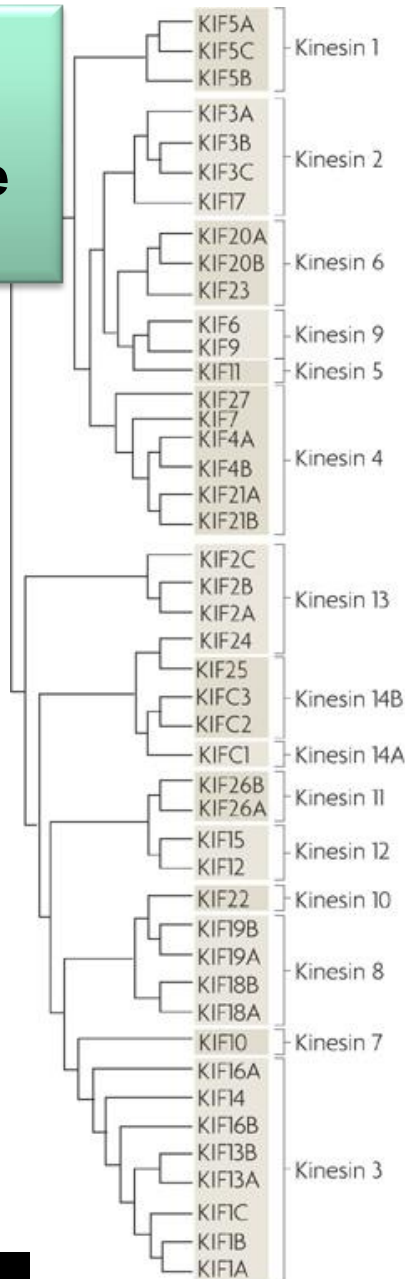

Box 1 | General mechanism of kinesin-mediated cellular transport

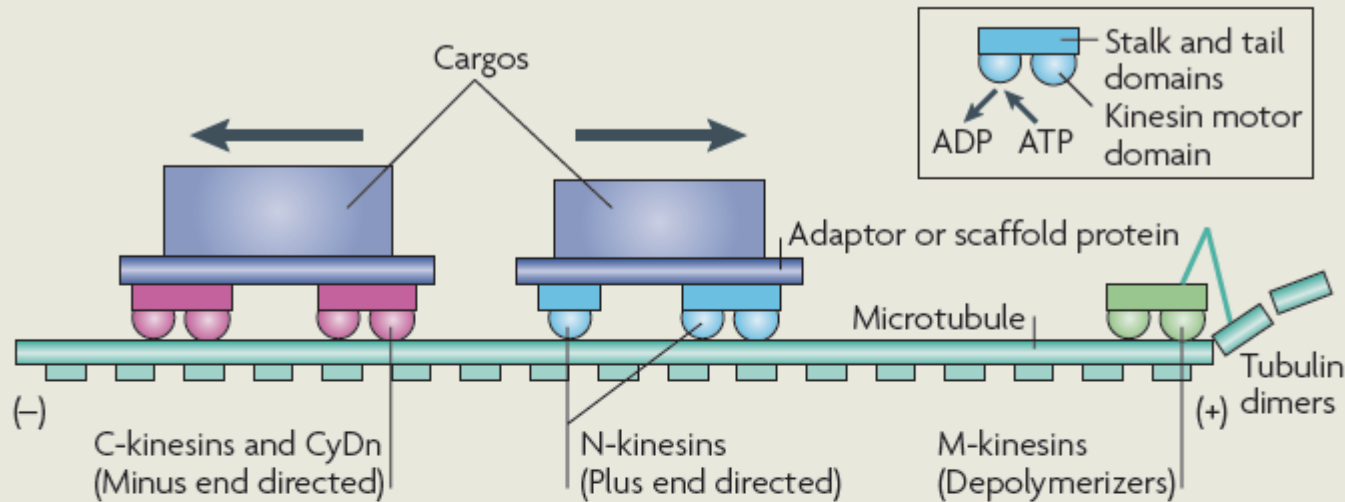

Kinesins transport cargos along microtubules by a standard mechanism (depicted here using a freight train model; see the figure). A kinesin motor generally consists of a kinesin motor domain, which is conserved among kinesin superfamily proteins (KIFs), and unique stalk and tail domains that are used for kinesin dimerization and/or kinesin binding to cargos, adaptors or scaffold proteins. The kinesin motor domain generates force by hydrolysing ATP. Kinesins are largely classified as N-kinesins, M-kinesins or C-kinesins, which contain their motor domain at the amino terminus, in the middle or at the carboxyl terminus, respectively. N-kinesins generally provide plus end-directed motility that is anterograde towards the cell periphery or axon terminals in neurons. Some N-kinesins act as monomers and others act as dimers. C-kinesins, together with cytoplasmic dynein (CyDn), provide minus end-directed motility that is generally retrograde towards the cell centre. M-kinesins depolymerize microtubules. In some cases, adaptors and scaffolds provide a mechanistic link between kinesins and cargos, and they might also have regulatory roles in kinesin-driven intracellular transport, namely in the recognition of specific cargos and the regulation of cargo loading and unloading.

Cargo-bound motors are regulated by organelle-specific complements of scaffolding and adaptor proteins.

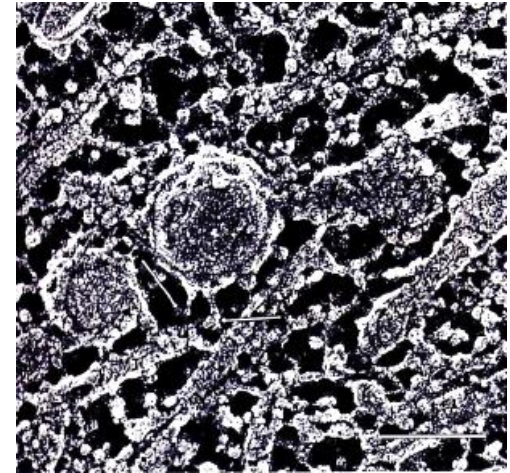
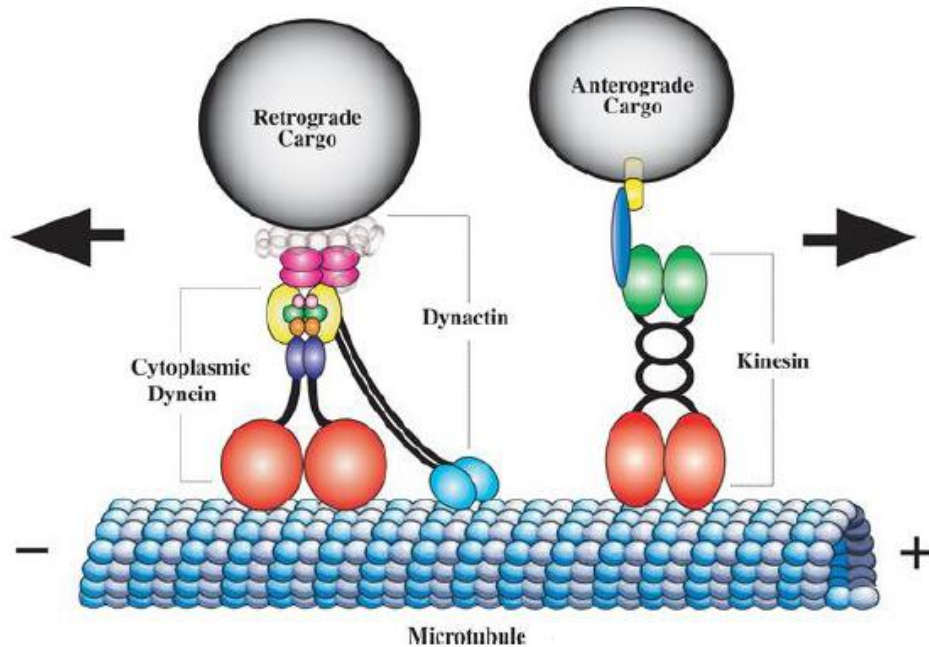

The complement of **motors**, **adaptors**, and **scaffolding** proteins bound to each cargo is organelle specific, leading to distinct patterns of motility and localization along the axon.

Intracellular transport by molecular motors in neurons, non-neuronal cells and cilia.

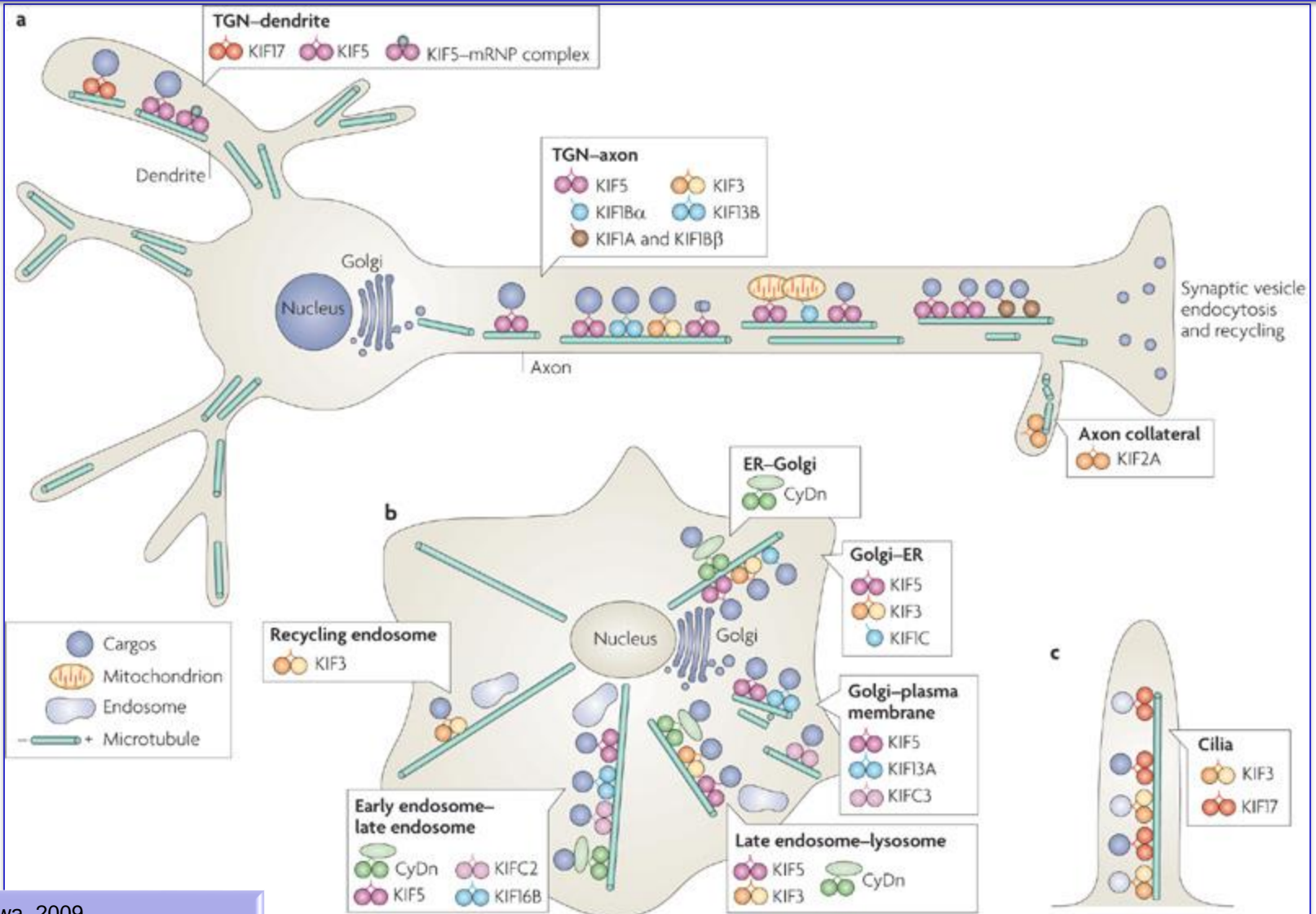

Hirokawa 2009
 Nature Reviews Mol Cell Biology
 doi:10.1038/nrm2774

Opposing motors bind simultaneously to cargos along the axon

Many axonal cargos have multiple motor types bound simultaneously.

Quantitative analyses and live-cell trapping experiments suggest that 1–2 kinesins and 6–12 dyneins may act together to move a single organelle along the microtubule.

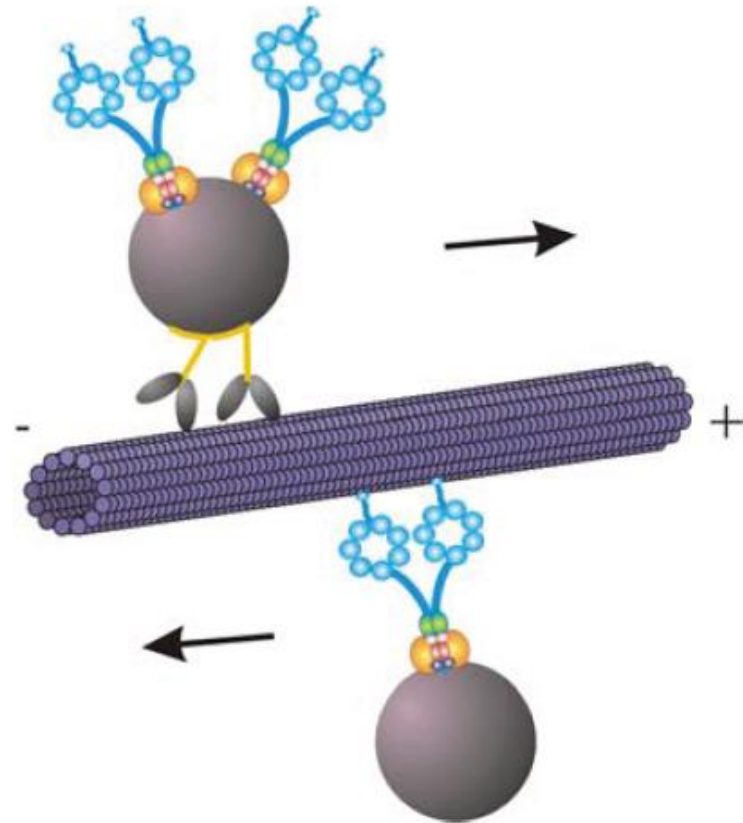

Some cargos are 'handed off' from MTs to actin filaments for local transport

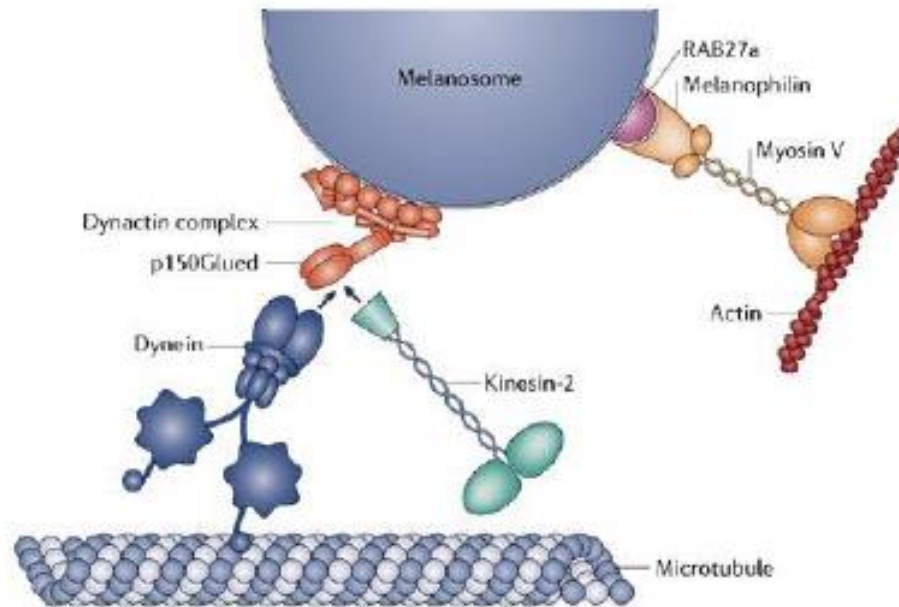

Copyright © 2005 Nature Publishing Group
Nature Reviews | Molecular Cell Biology

How is cargo transported along actin filaments?

Answer: Myosin motors

In dendritic spines, vesicular cargoes **switch from microtubules to actin filaments**, where Myosin motors are used for short distance transports

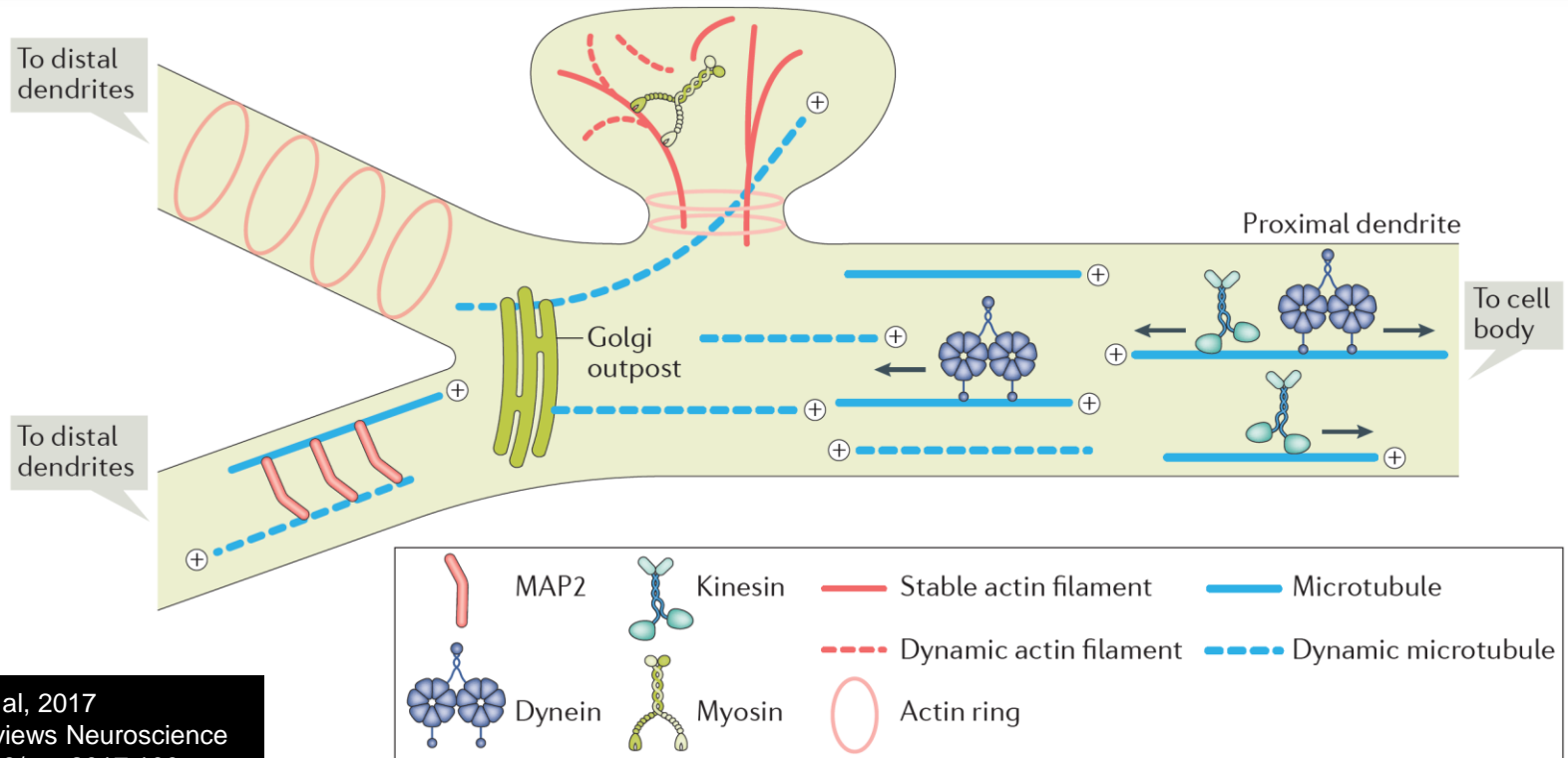

Nirschly et al, 2017
 Nature Reviews Neuroscience
 doi:10.1038/nrn.2017.100

Figure 4 | **The cytoskeletal organization of dendrites.** The dendritic shaft is enriched in microtubules, whereas dendritic spines are actin-rich; both stable and dynamic microtubules and actin filaments are present. Actin rings are found in the shaft and spine neck, and they may provide structural support. Owing to the mixed polarity of dendritic microtubules, both dynein and kinesins regulate the transport of retrograde and anterograde cargoes, whereas myosins mediate trafficking into and out of spines. Microtubules may be transported into dendrites by motors or nucleated at Golgi outposts and are enriched in microtubule-associated proteins (MAPs) such as MAP2. In this compartment, long-range transport must be balanced against the dynamics of the underlying microtubule tracks and overall dendritic morphology.