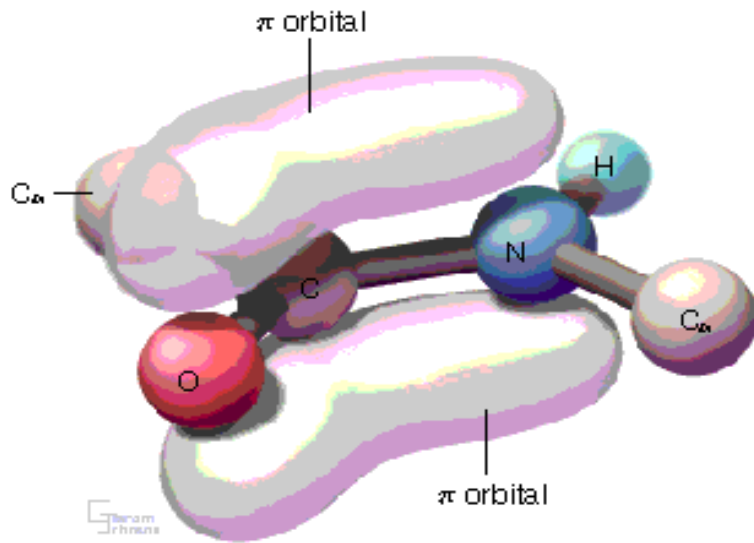
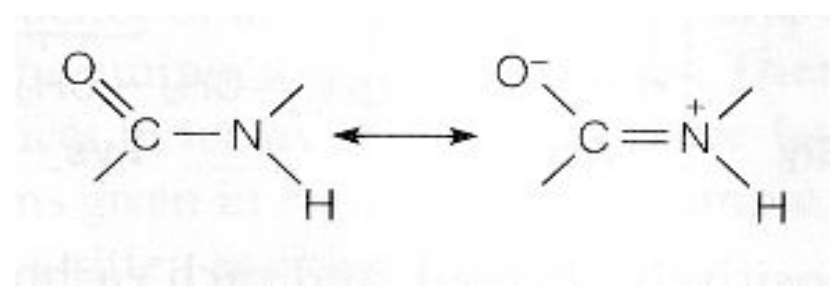




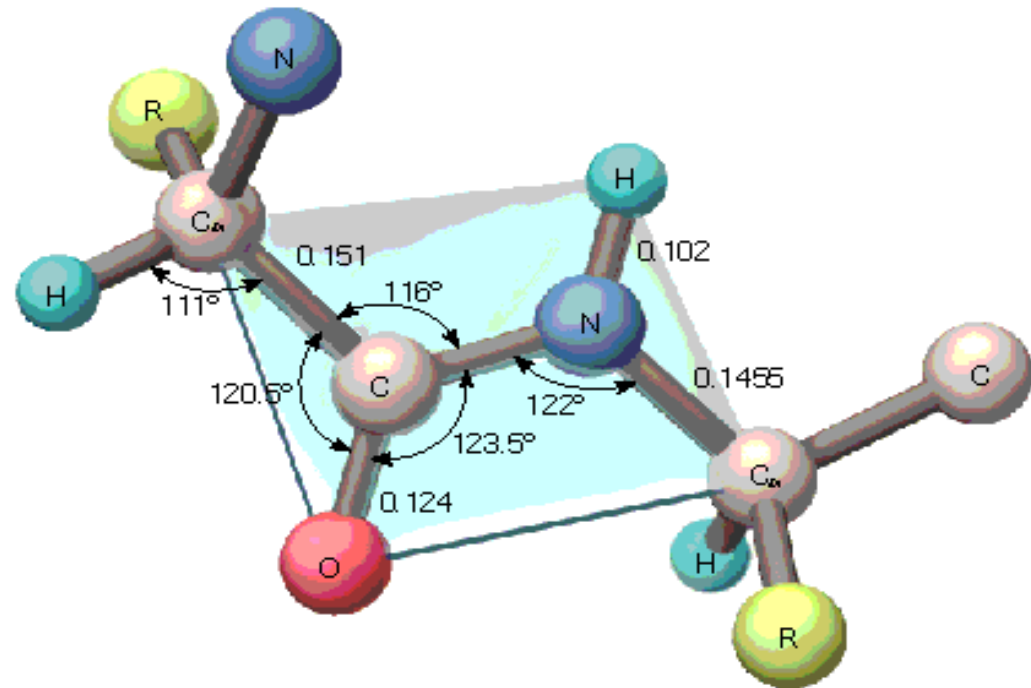
# 3. Secondary and tertiary structure in proteins

---

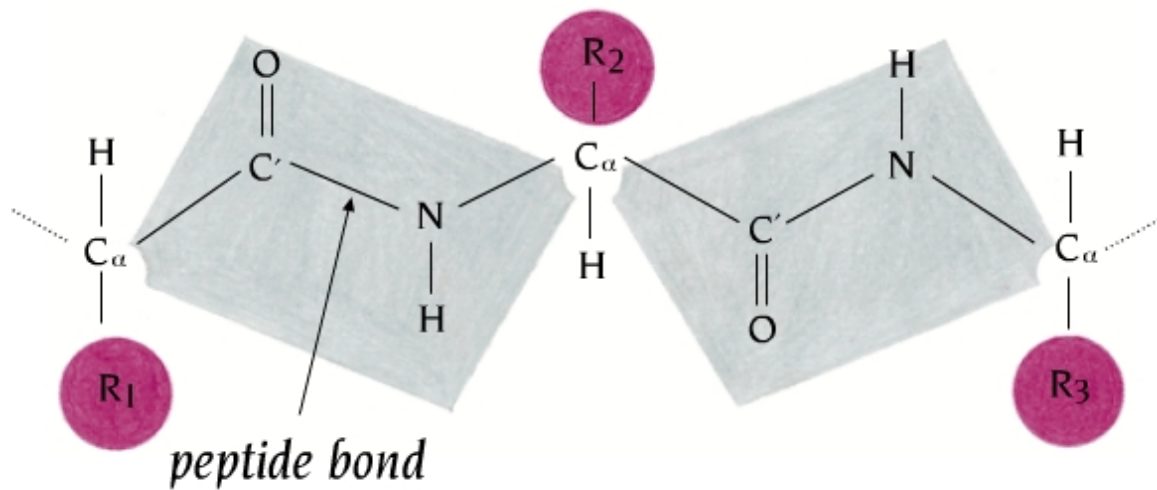
# Peptide bond



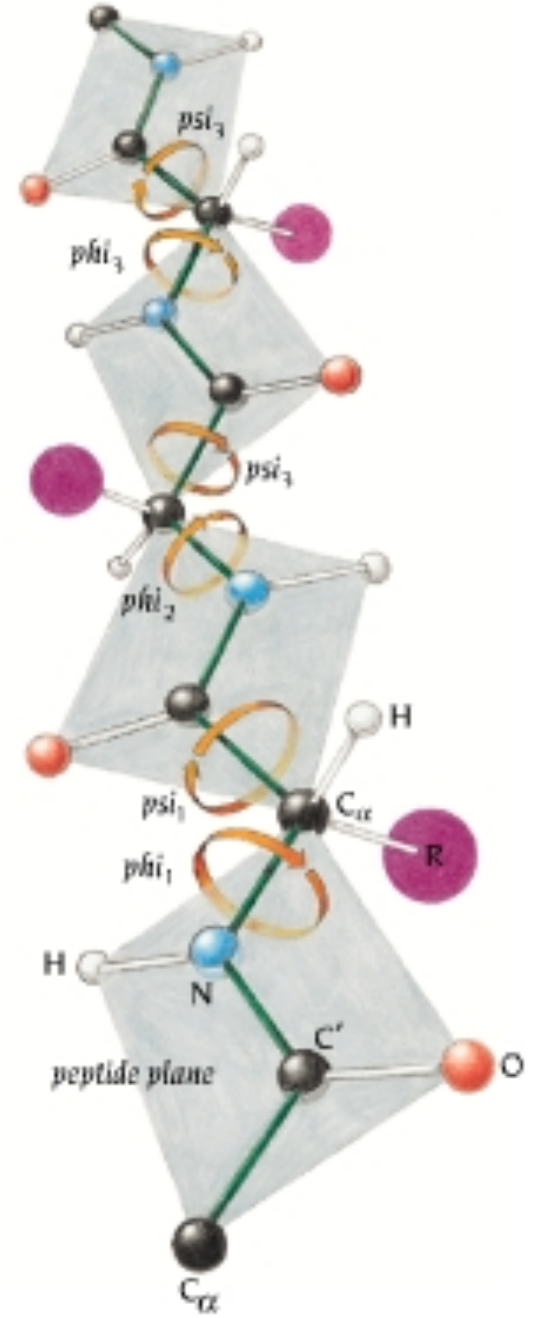
(a) Partial double-bond character of peptide bond



(b) Bond angles and lengths

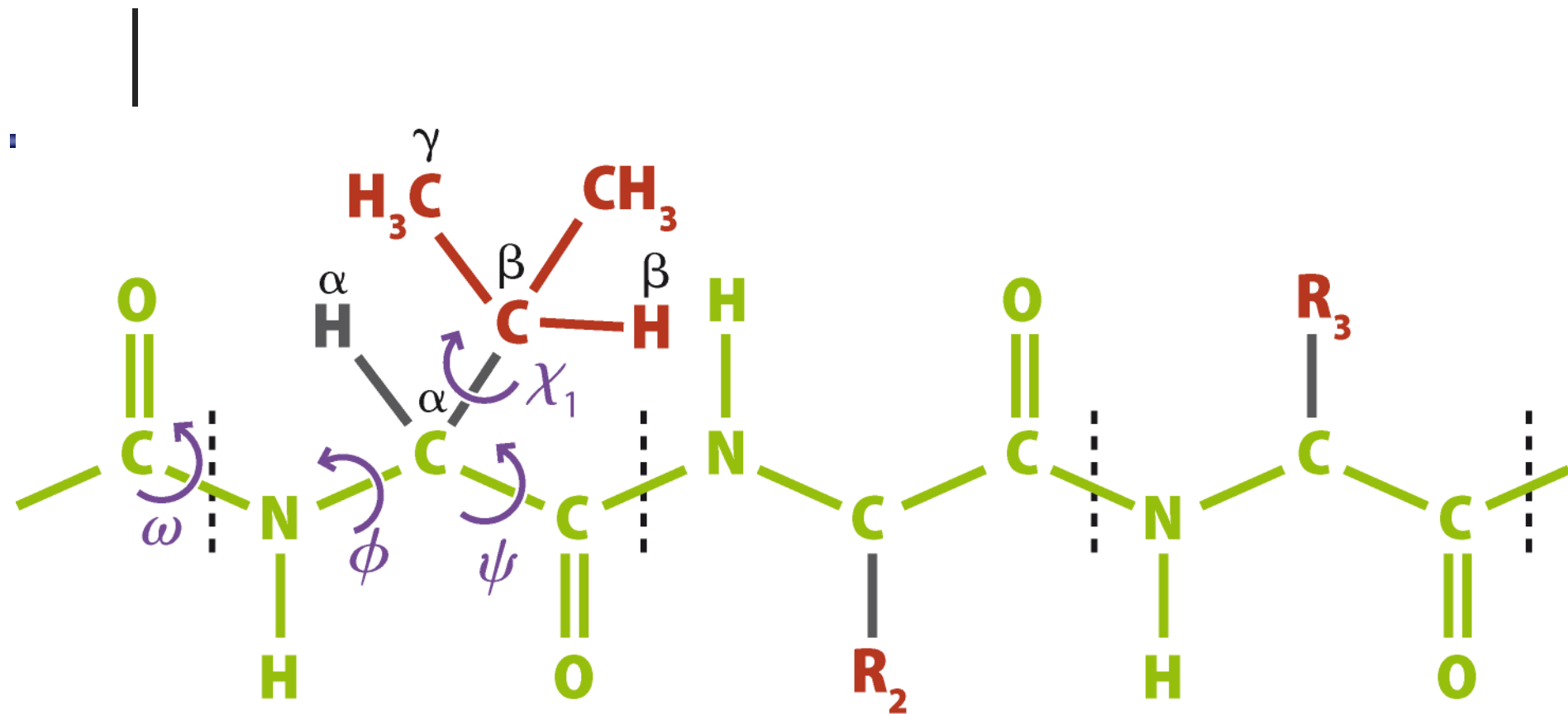


© 1999 GARLAND PUBLISHING INC.  
A member of the Taylor & Francis Group



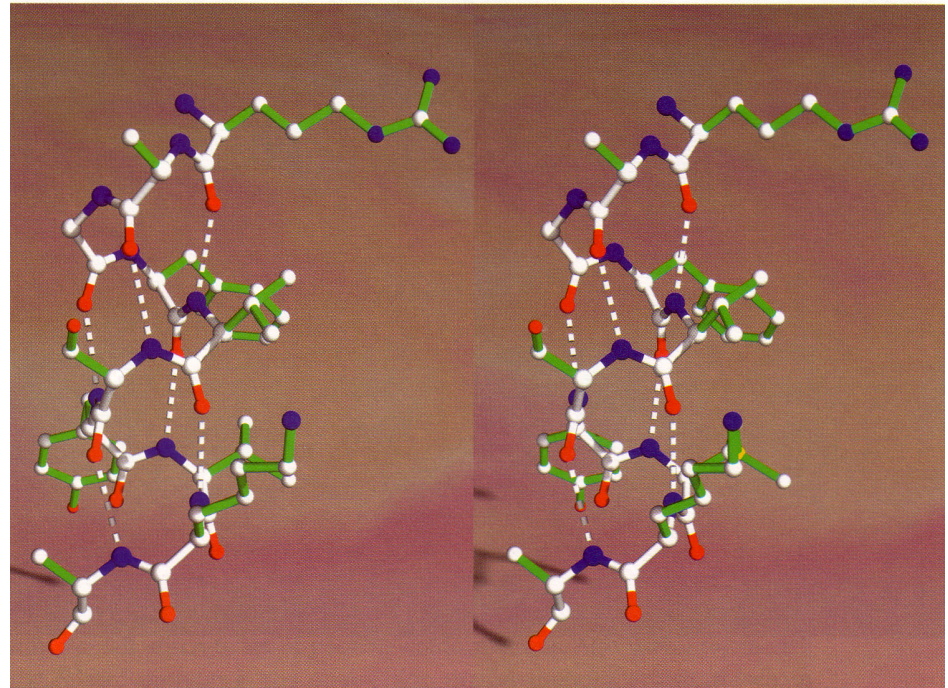
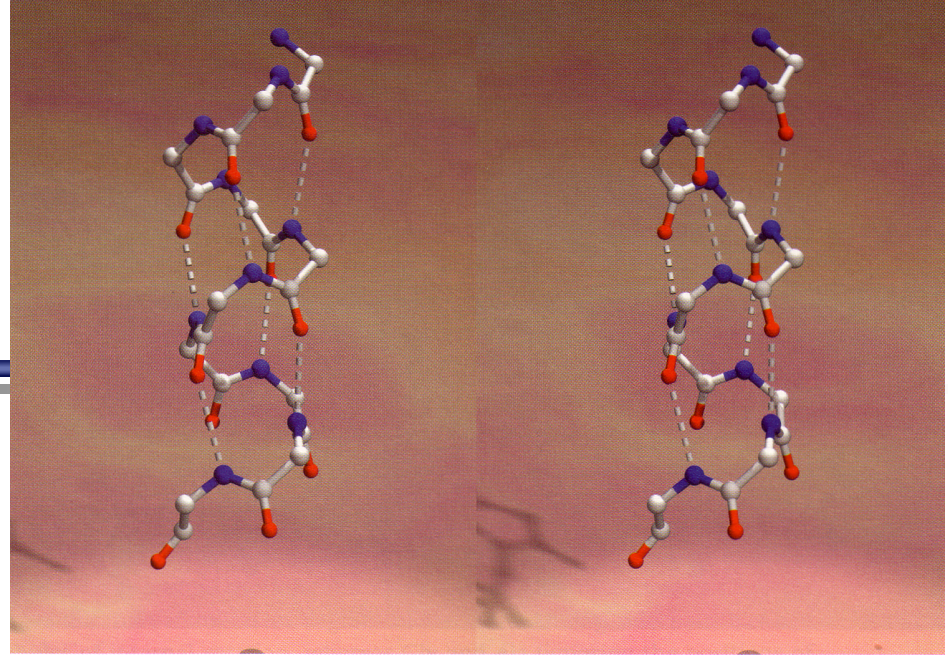
© 1999 GARLAND PUBLISHING INC.  
A member of the Taylor & Francis Group

# Dihedral angles

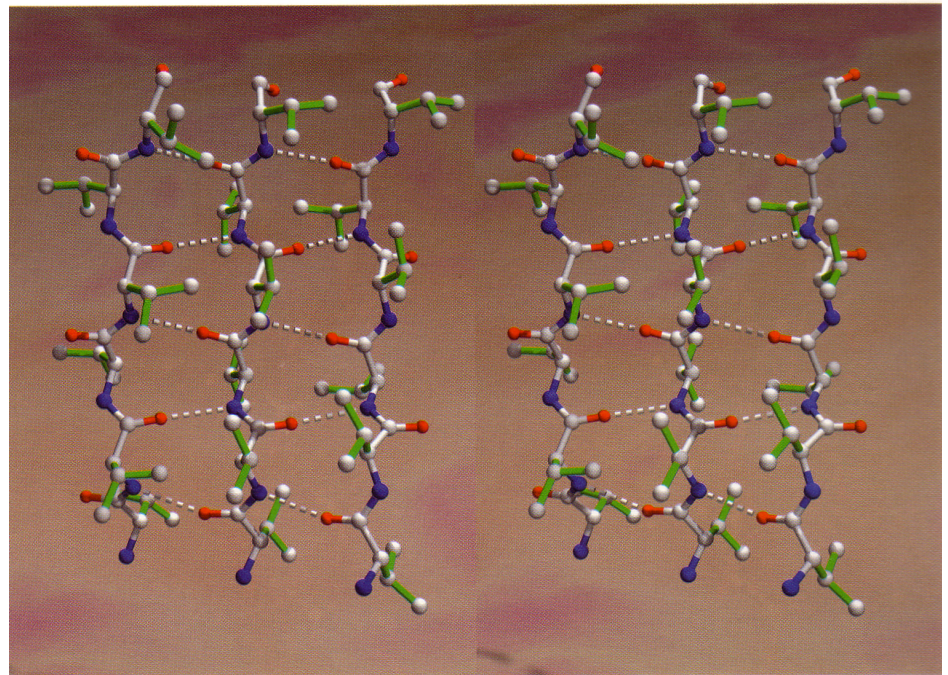
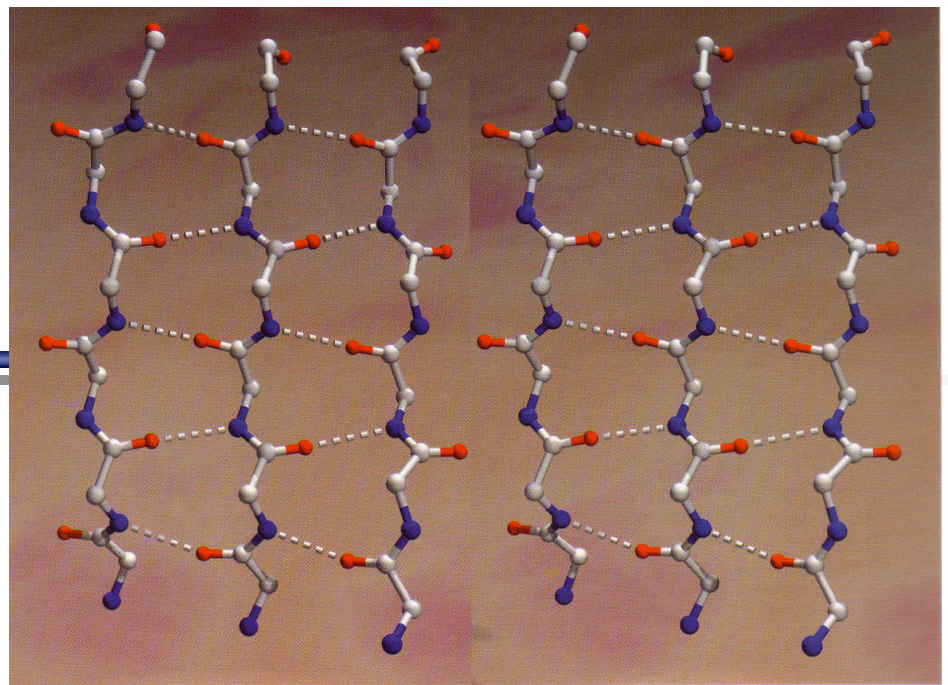


# Secondary structure

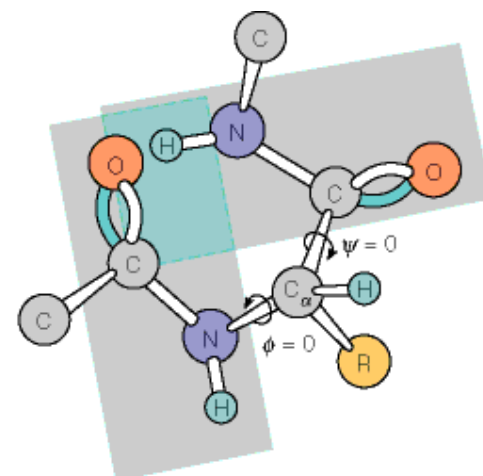
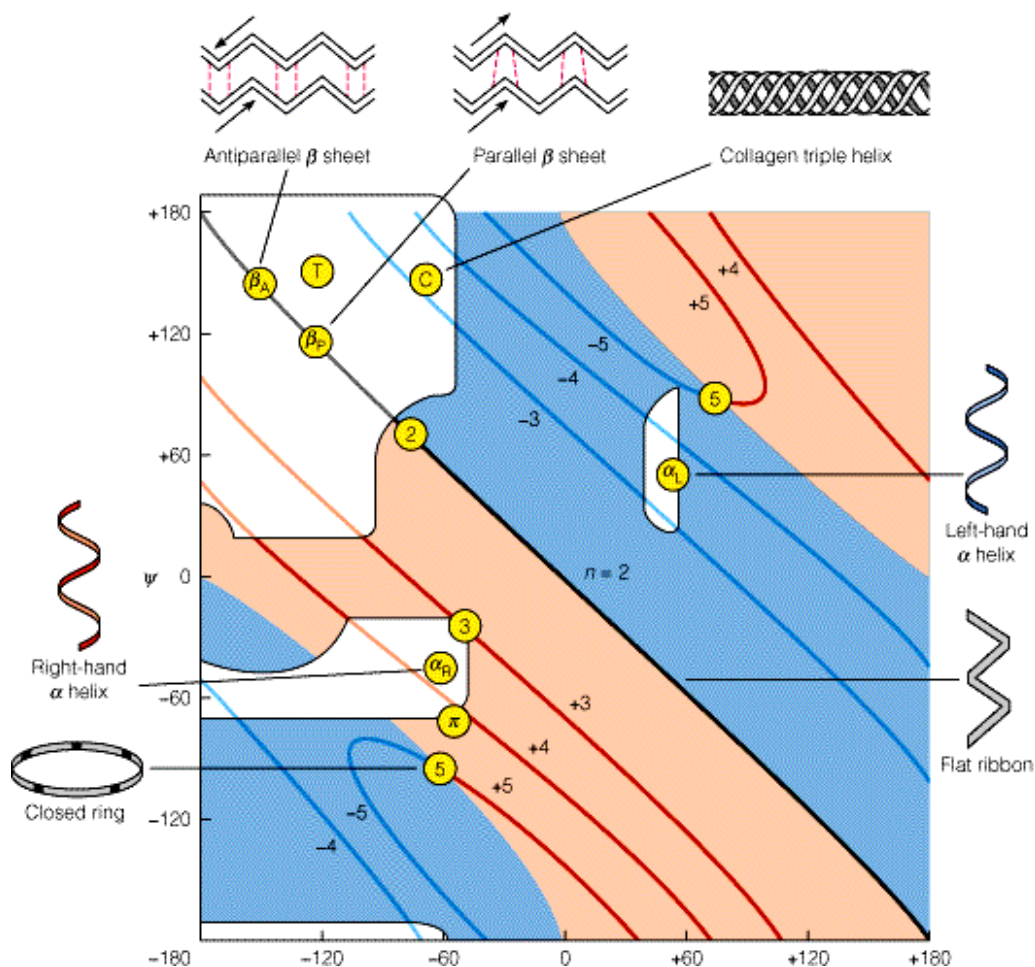
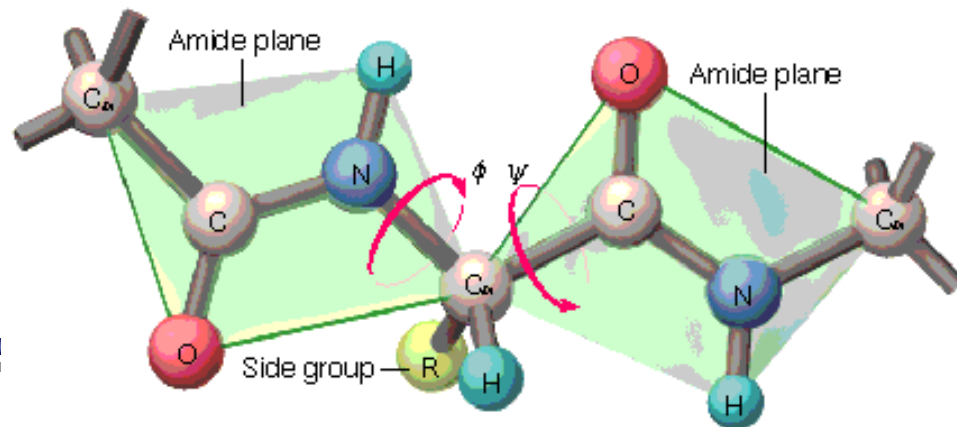
- Alpha-helix without/with side chains



- Beta-strands forming a beta-sheet, without/with side chains

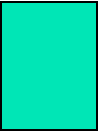


# Ramachandran plot:

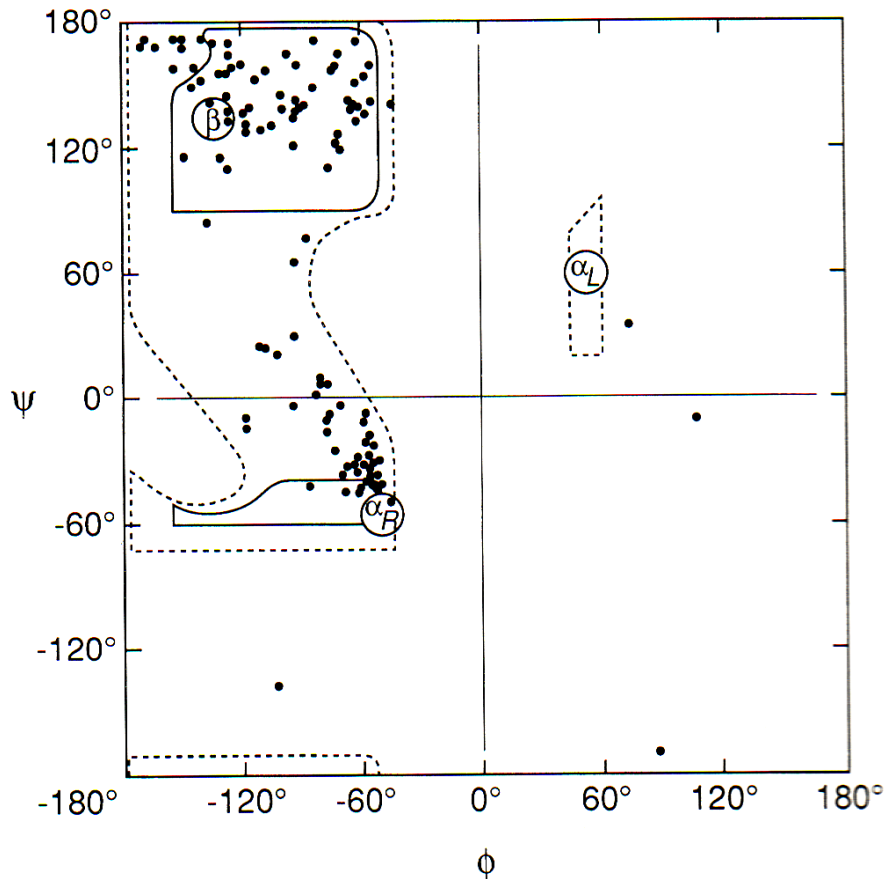


Example of sterically non-allowed conformation for  $\phi = 0$ ;  $\psi = 0$

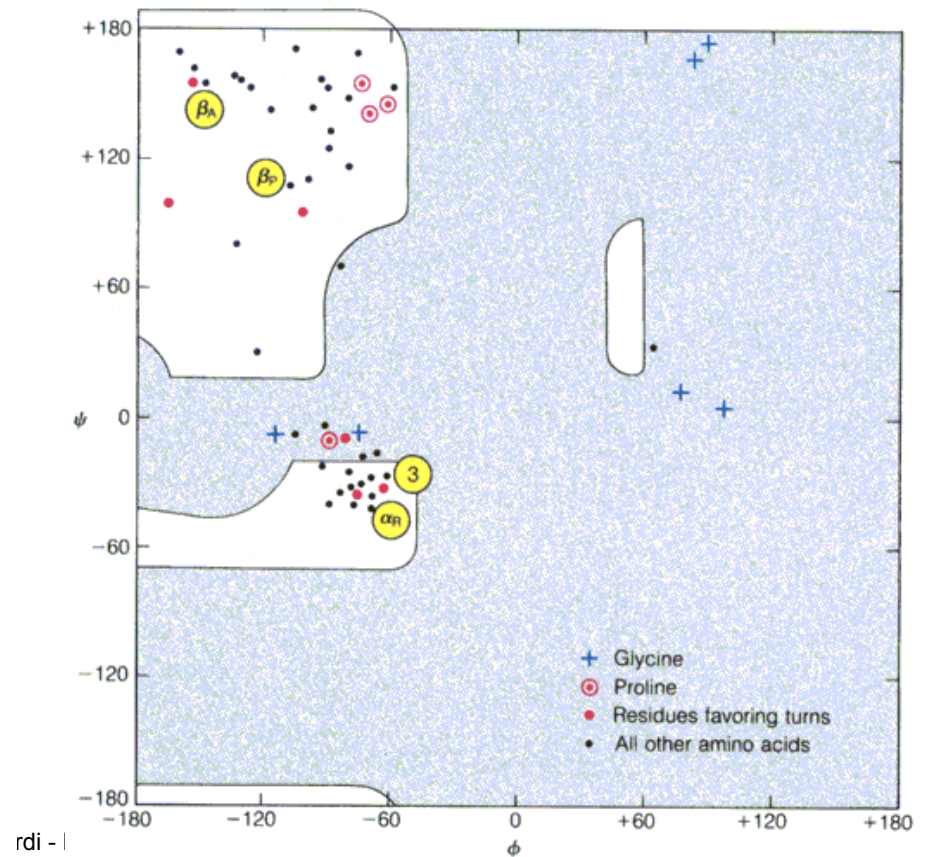
# Sasisekhran-Ramakrishnan-Ramachandran diagram



Ribonuclease A

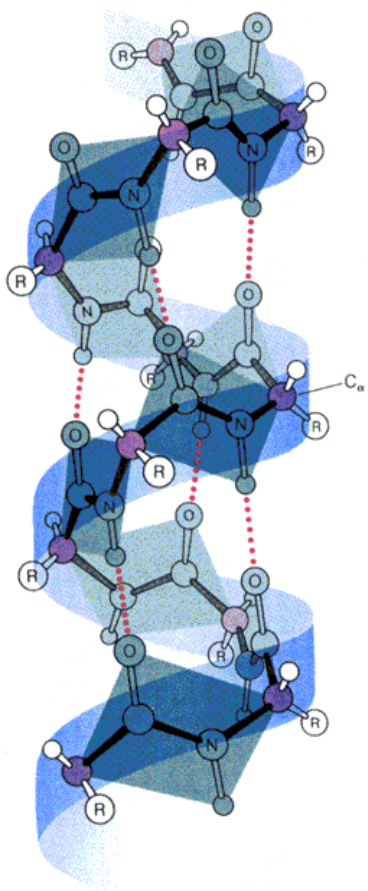


BPTI = Bovin Pancreatic Trypsin Inhibitor

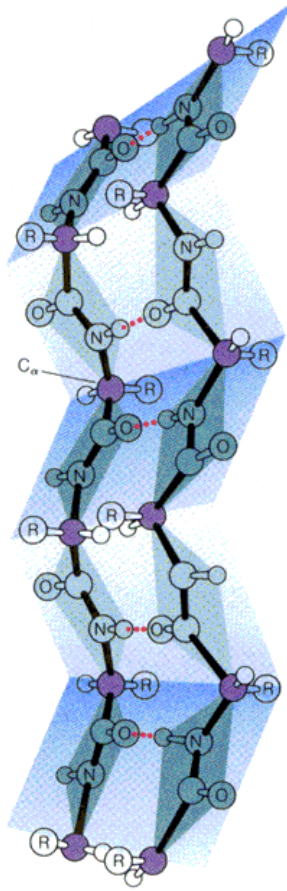




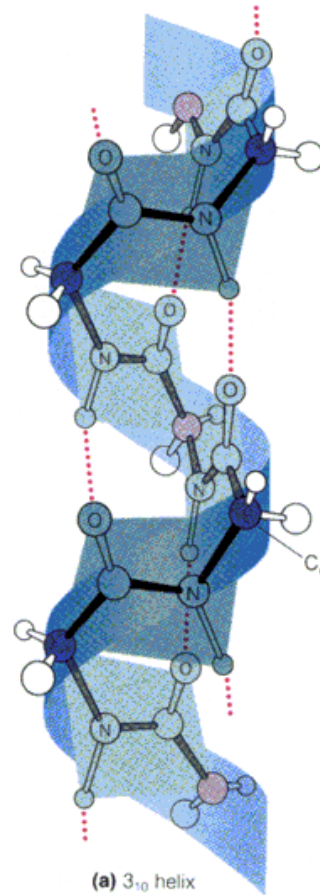
# Elements of 2ary structure



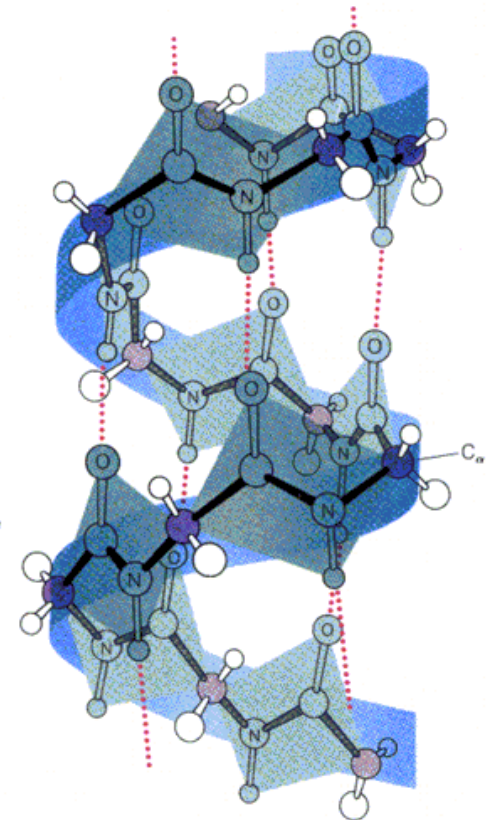
(a)  $\alpha$  helix  
 $\alpha$ -helix



(b)  $\beta$  sheet  
 $\beta$ -sheet



(a)  $3_{10}$  helix

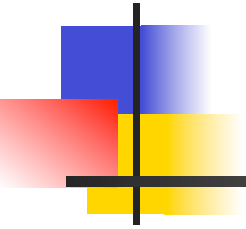


(b)  $\pi$  helix

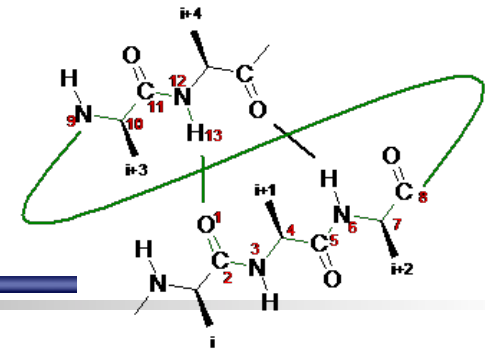
$3_{10}$ -helix

$\pi$ -helix

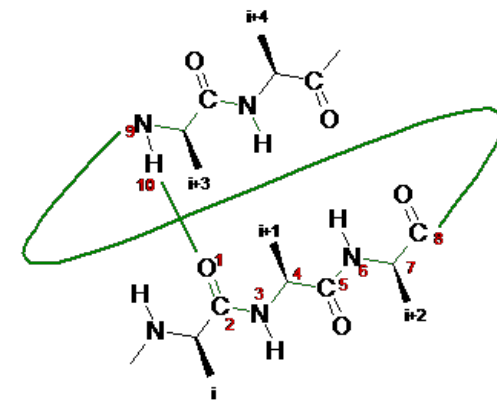
# Helices



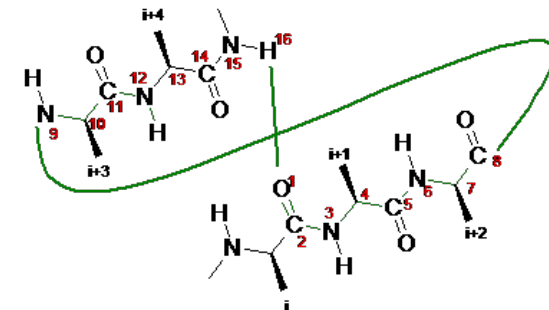
3.6-13 Alpha Helix



3-10 Helix



4.4-16 Pi Helix

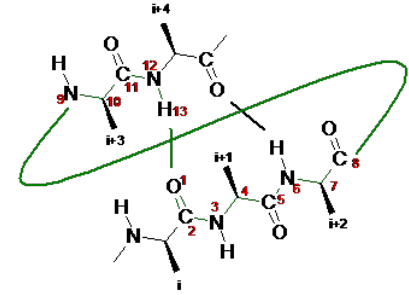


Structure Type	Residues/ Turn	Rise (nm)	Number of Atoms in H-Bonded Ring	$\phi$ ( $^{\circ}$ )	$\psi$ ( $^{\circ}$ )
Antiparallel $\beta$ sheet	2.0	0.34	— <sup>a</sup>	-139	+135
Parallel $\beta$ sheet	2.0	0.32	— <sup>a</sup>	-119	+113
$3_{10}$ helix	3.0	0.20	10	-49	-26
$\alpha$ helix (3.6 <sub>13</sub> )	3.6	0.15	13	-57	-47
$\pi$ helix (4.4 <sub>16</sub> ) <sup>b</sup>	4.4	0.12	16	-57	-70

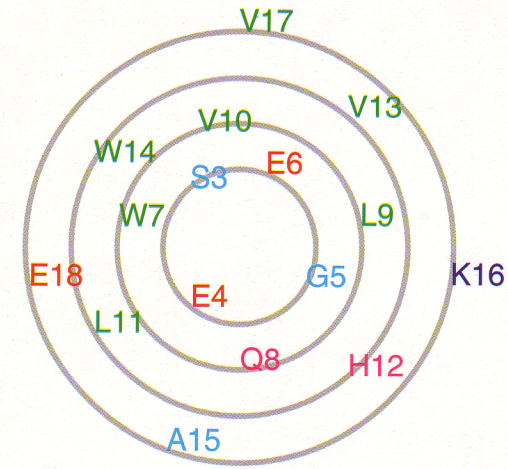
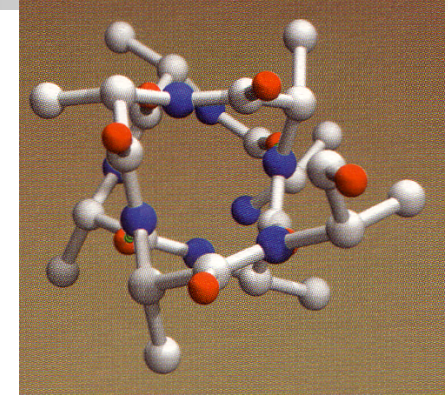
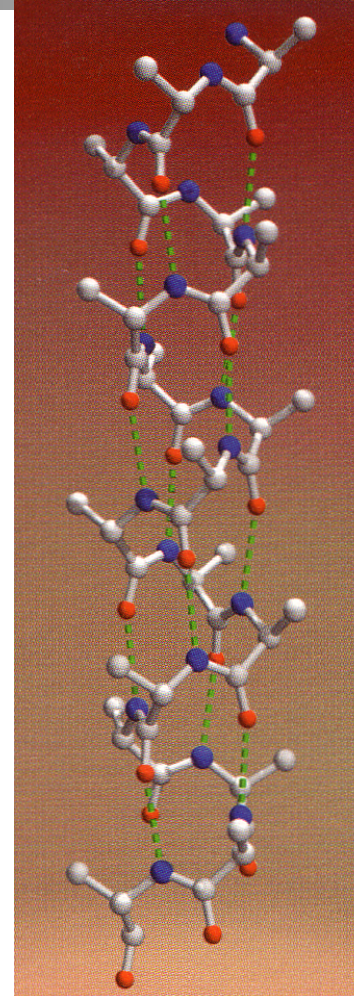
<sup>a</sup>Bonding is between polypeptide chains.

<sup>b</sup>Sterically permitted but not observed in protein.

# The $\alpha$ -helix

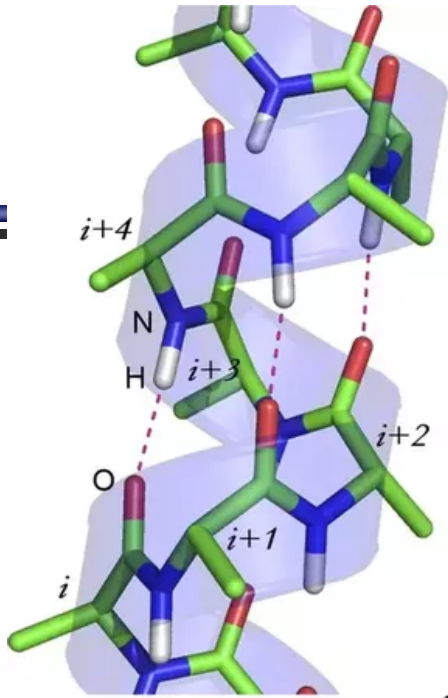


- It is the most common type of helix
- The C=O group of residue  $i$  forms a H-bond with the NH group of residue  $i+4$
- One residue is related to the next by a rotation of approximately  $100^\circ$  around the helix axis and with a translation along the axis by  $1.5 \text{ \AA}$
- Many  $\alpha$ -helices present an asymmetric distribution of hydrophilic/hydrophobic residues

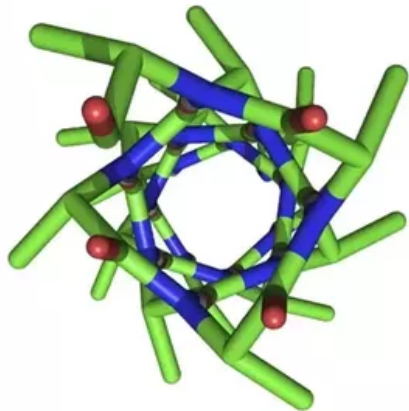


Helical wheel:  
Helix A from  
sperm whale myoglobin

# $\alpha$ -helix

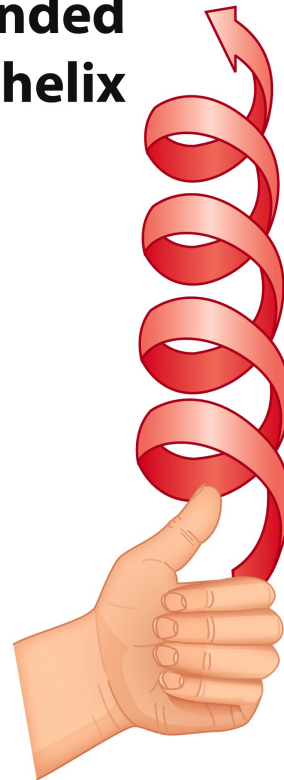


C

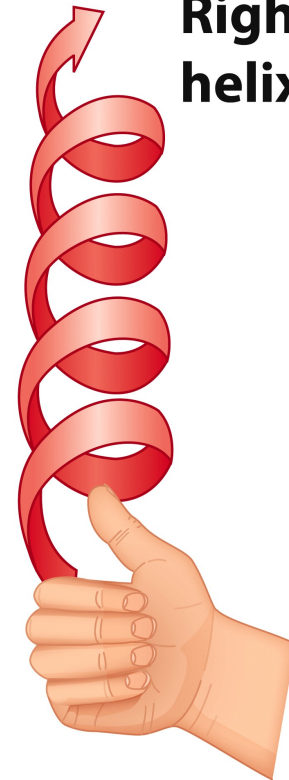


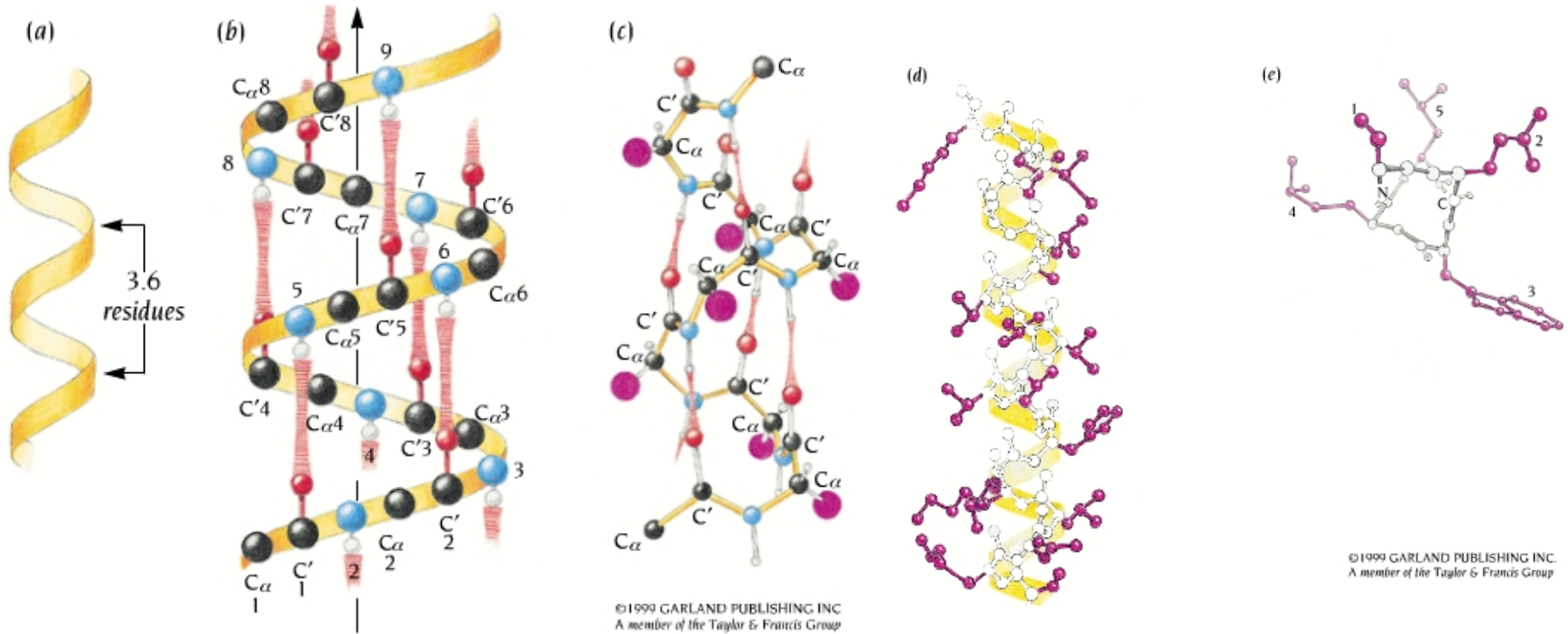
Canonical  $\alpha$ -helix

**Left-handed helix**



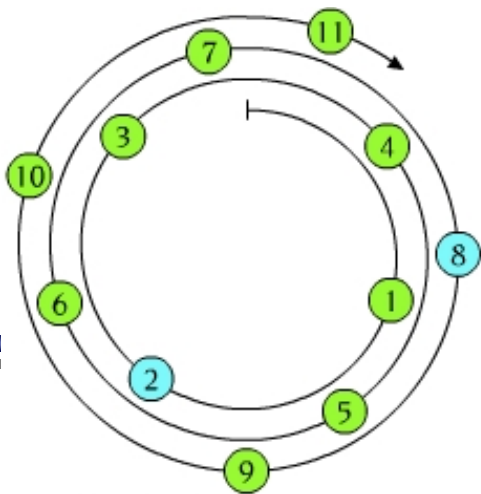
**Right-handed helix**



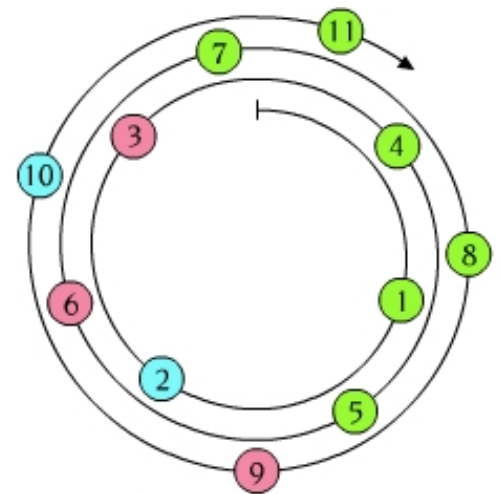


- Length: from 4/5 aa to over 40 aa
- Average length: 10 aa
- 3.6 aa per turn
- $360^\circ : 3.6 = 100^\circ$  rotation per aa per turn
- Rise: 1.5Å per aa; then an average helix is 15Å long
- Ala, Glu, Leu, Met: good helix formers
- Pro, Gly, Tyr, Ser: bad helix formers

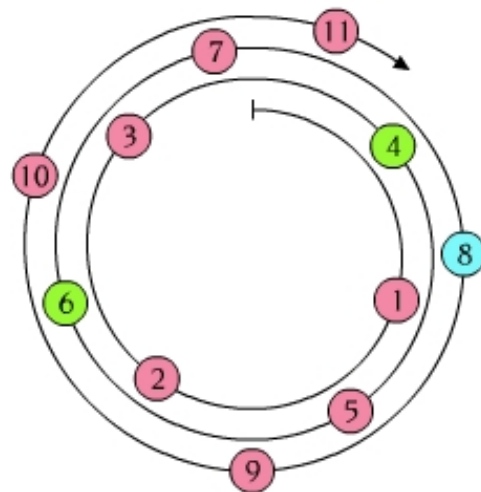
- Helices tend to be along the outside of proteins, giving a periodicity of 3.6 with hydrophobic/hydrophilic aa
- Convenient representatio: helical wheel



*citrate synthase*  
 1 2 3 4 5 6 7 8 9 10 11  
 L S F A A A M N G L A



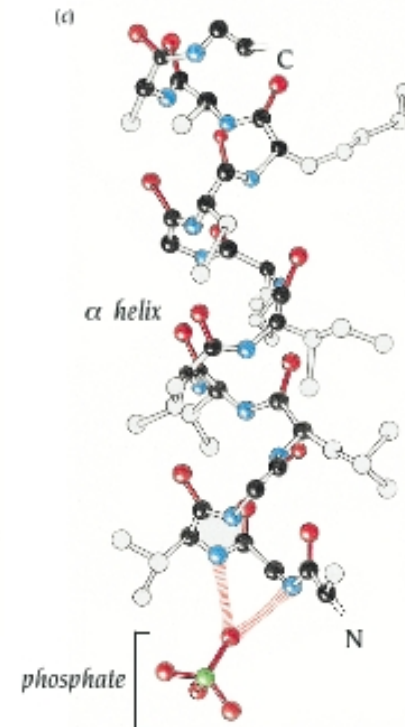
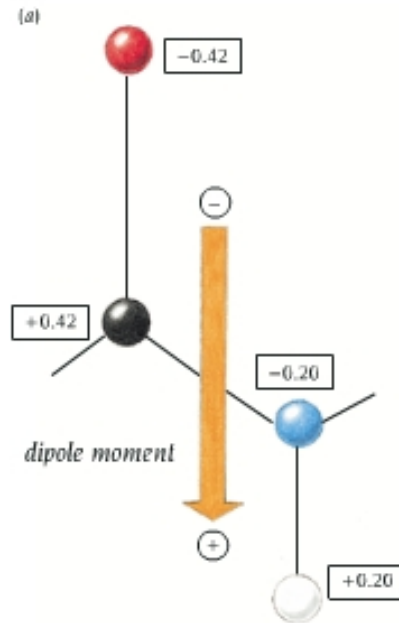
*alcohol dehydrogenase*  
 1 2 3 4 5 6 7 8 9 10 11  
 I N E G F D L L R S G



*troponin-C*  
 1 2 3 4 5 6 7 8 9 10 11  
 K E D A K G K S E E E

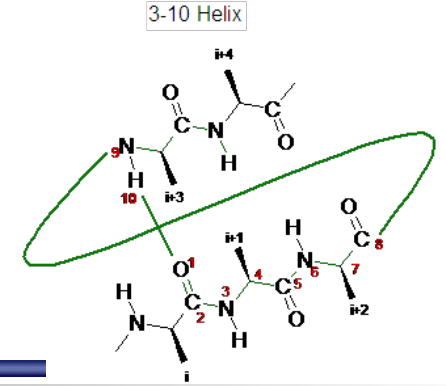
# Helices have a dipole moment

- ✓ A dipole is associated to each peptide unit;
- ✓ In an  $\alpha$ -helix, these dipoles are aligned along the helix axis;
- ✓ Dipoli associated to the peptide units sum up to give a **helix macrodipole**

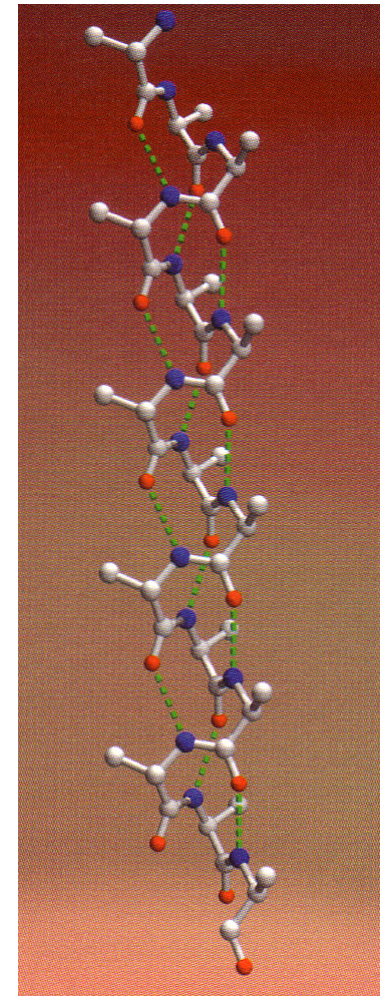
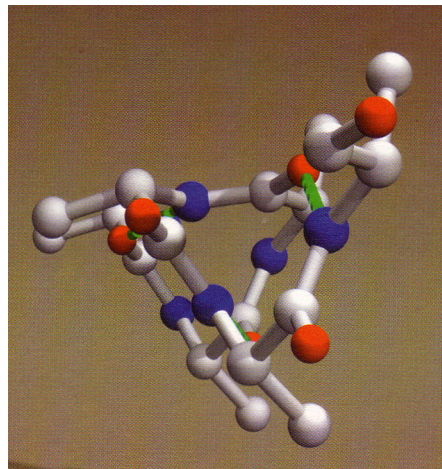




# The $3_{10}$ helix



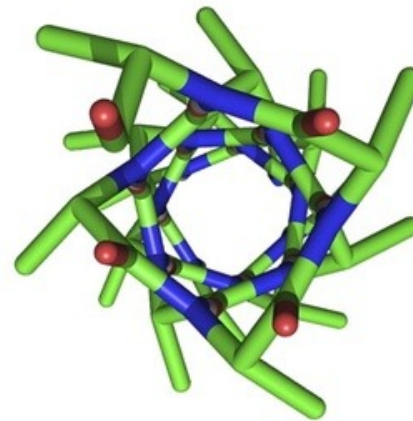
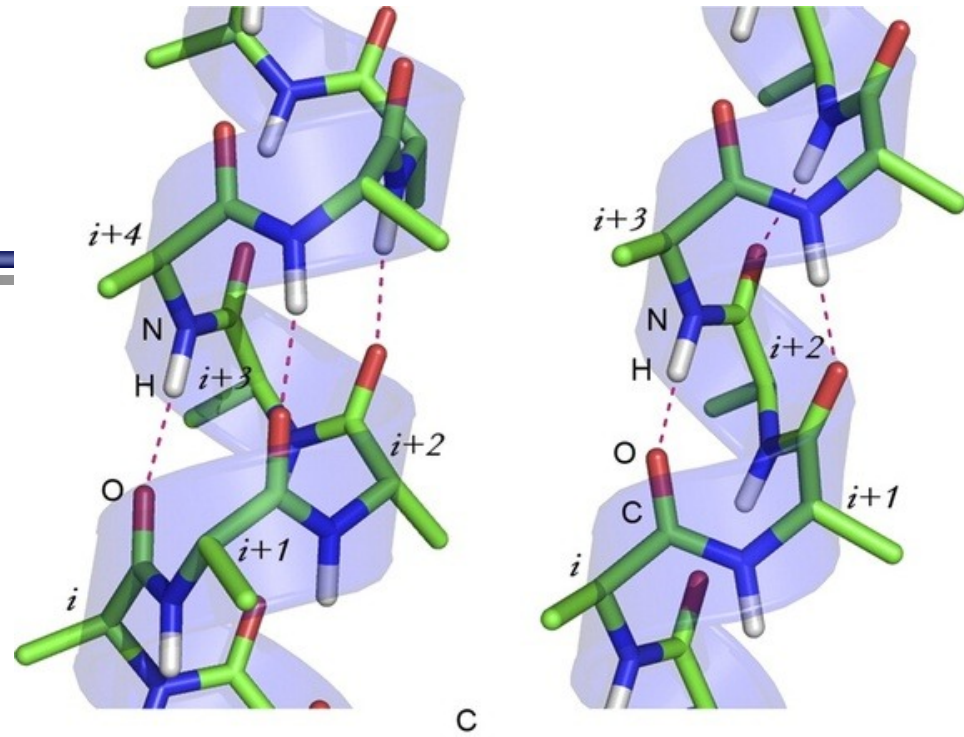
- It winds up more tightly than an  $\alpha$ -helix
- The C=O group of residue  $i$  forms a H-bond with the NH group of residue  $i+3$



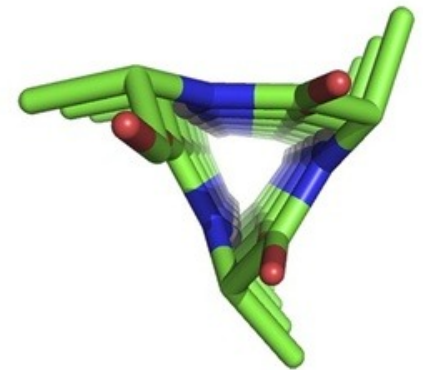
# The $3_{10}$ helix

The  $3_{10}$  helices are less favored of the  $\alpha$  helices:

- the atoms of the main chain are too closely packed, leading to interactions of the van der Waals repulsion;
- hydrogen bonds are not linear;
- The dipoles of the peptide deviate of about  $30^\circ$  with respect to the helix axis;
- The position of the side chains (aligned) leads to steric interference.

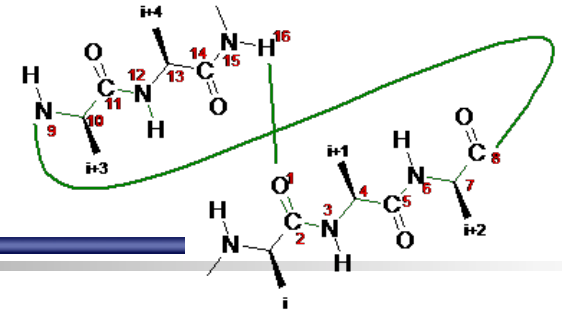


Canonical  $\alpha$ -helix

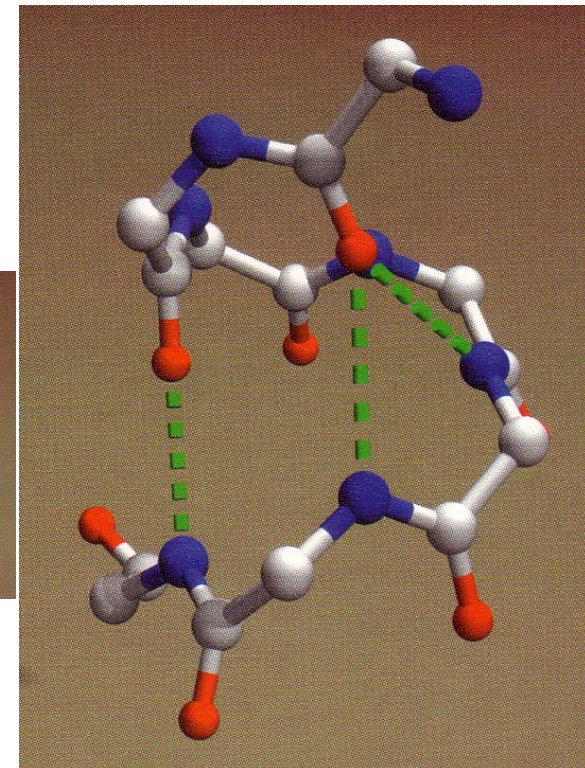
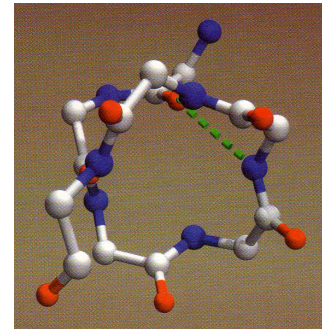


Canonical  $3(10)$  helix

# $\Pi$ -helix



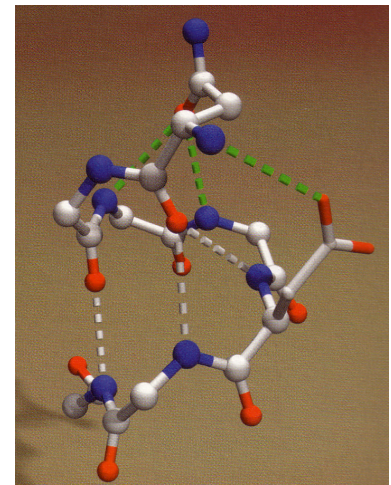
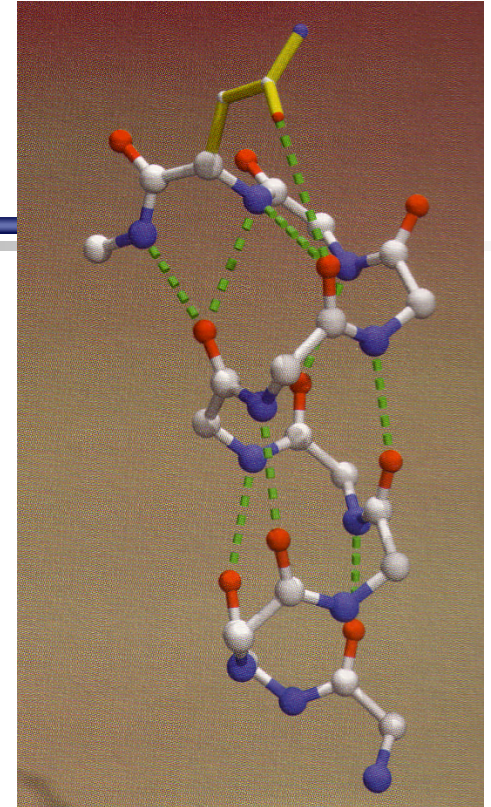
- It winds up less tightly than an  $\alpha$ -helix
- The C=O group of residue  $i$  forms a H-bond with the NH group of residue  $i+5$
- This type of extended  $\pi$ -helices are rare in proteins
- The  $\pi$ -helix can be outlined as a hollow cylinder.
- The cavity in the cylinder, however, is not such as to allow the entry of water molecules that may stabilize the helix.
- This makes the  $\pi$ -helix structure a little favored from an energy point of view and extremely uncommon in proteins.



$\pi$ -helix from photoactive yellow protein [2PHY]

# Helix capping

- Often special sequences and conformations appear as caps stabilising helix termini
- Helix-capping motifs are specific patterns of hydrogen bonding and hydrophobic interactions found at or near the ends of helices in both proteins and peptides.
- At the N-terminal helix there are 3 free NH groups, which do not form hydrogen bonds with CO groups, because there is no previous helix turn that provides the necessary partners.
- In this case the necessary partners to form hydrogen bonds are provided to the free -NH groups from the side chains of polar amino acids (Ser, Thr, Asp, Asn) which, in favorable cases, precede the end of the  $\alpha$ -helix.
- These hydrogen bonds then occur between an element of the main polypeptide chain and one of the side chain.



## Structural parameters for protein secondary structures

Structure	$\phi$	$\psi$	$n$	$d$	$p$
$\alpha$ -helix	-57	-47	3.6	1.5	5.5
$3_{10}$ helix	-49	-26	3.0	2.0	6.0
$\beta$ -helix	-57	-70	4.4	1.1	5.0
Polyproline II helix	-79	+149	3.0	3.1	9.4
Parallel $\beta$ strand	-119	+113	2.0	3.2	6.4
Antiparallel $\beta$ strand	-139	+135	2.0	3.4	6.8

$\phi$  and  $\psi$  are the conformational angles of the mainchain, with  $\omega \sim 180^\circ$  (the trans conformation)

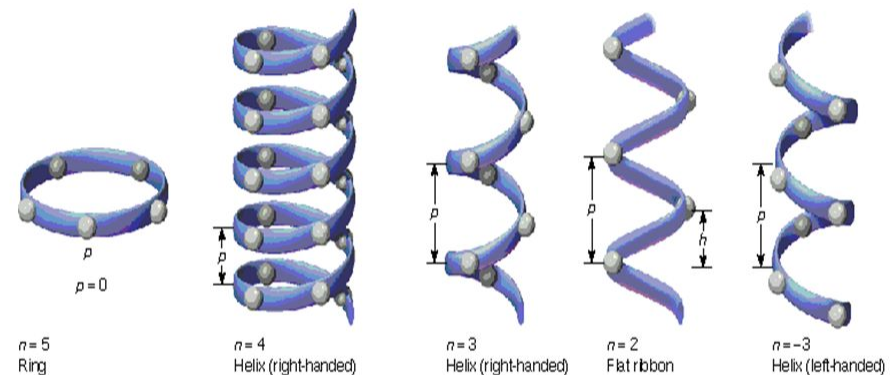
$n$  = the number of residues per turn.

$d$  = the displacement between successive residues along the helix axis.

$p$  = the pitch of the helix, the distance along the helix axis of a complete turn.

Note that  $p = n \times d$ . (The equation is exact; the values of  $p$ ,  $n$  and  $d$  in the table have been rounded to two significant figures.)

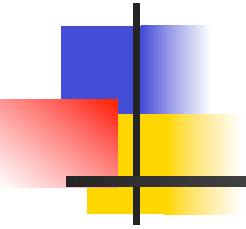
### Idealized helices




The pitch ( $p$ ) of the helix is the distance parallel to the axis in which the helix makes one turn. There may be an integral number of residues/turn or not.

The rise of the helix is the distance parallel to the axis from the level of one residue to the next.

# $\beta$ -sheets



- 
- $\beta$ -sheets are formed by 2 strands distant in the sequence
  - By contrast, helices have H-bonding patterns in the same strand
  - They can be
    - Parallel sheets
    - Antiparallel sheets
    - Mixed sheets

# $\beta$ -sheets

$\beta$ -sheets are formed by 2 or more strands (5-10 residues) distant in the sequence

- ~~By contrast, helices have H-bonding patterns in the same strand~~
- They can be
  - Parallel sheets
  - Antiparallel sheets
  - Mixed sheets

## Structural parameters for protein secondary structures

Structure	$\phi$	$\psi$	$n$	$d$	$p$
$\alpha$ -helix	-57	-47	3.6	1.5	5.5
$3_{10}$ helix	-49	-26	3.0	2.0	6.0
$\beta$ -helix	-57	-70	4.4	1.1	5.0
Polyproline II helix	-79	+149	3.0	3.1	9.4
Parallel $\beta$ strand	-119	+113	2.0	3.2	6.4
Antiparallel $\beta$ strand	-139	+135	2.0	3.4	6.8

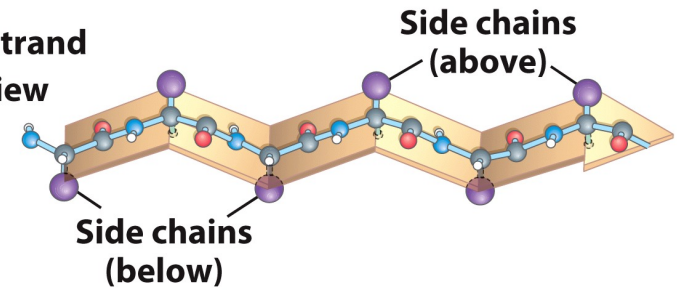
$\phi$  and  $\psi$  are the conformational angles of the mainchain, with  $\omega \sim 180^\circ$  (the trans conformation)

$n$  = the number of residues per turn.

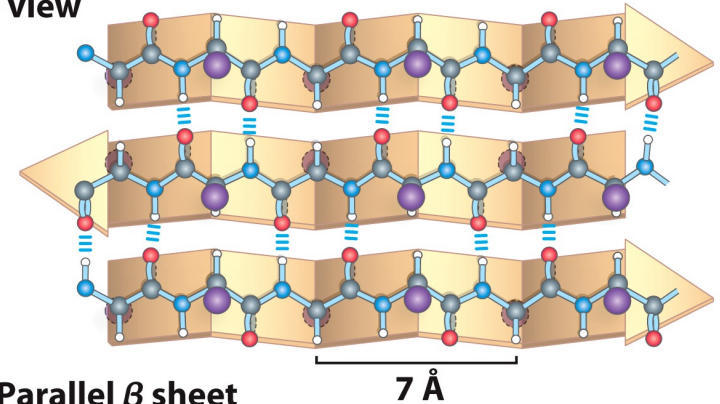
$d$  = the displacement between successive residues along the helix axis.

$p$  = the pitch of the helix, the distance along the helix axis of a complete turn. Note that  $p = n \times d$ . (The equation is exact; the values of  $p$ ,  $n$  and  $d$  in the table have been rounded to two significant figures.)

(a)  $\beta$  strand  
Side view



(b) Antiparallel  $\beta$  sheet  
Top view



(c) Parallel  $\beta$  sheet  
Top view

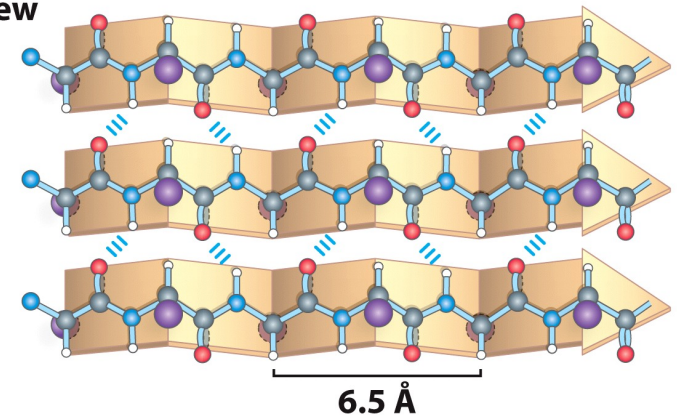
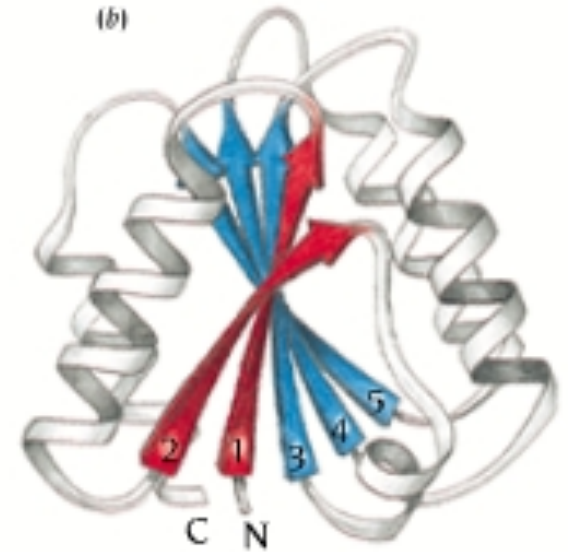
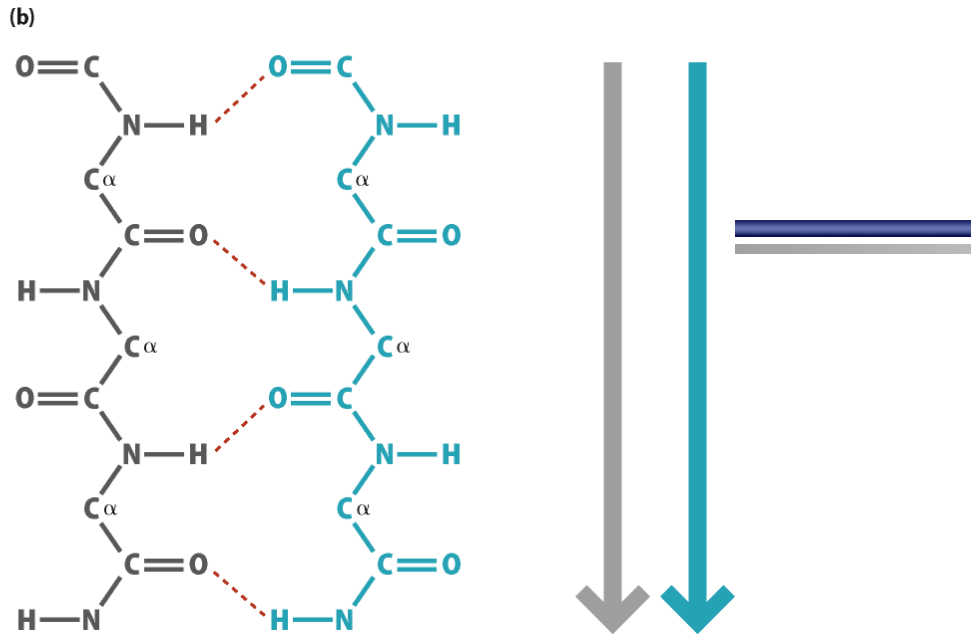


Figure 4-6

Lehninger Principles of Biochemistry, Sixth Edition  
© 2013 W. H. Freeman and Company

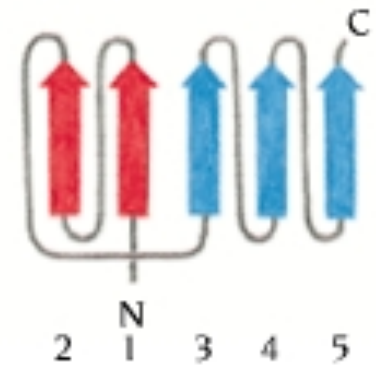
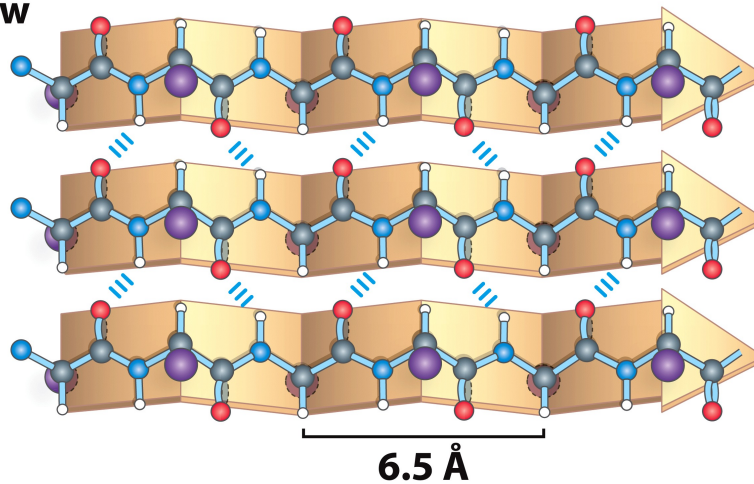


# Parallel $\beta$ -sheets



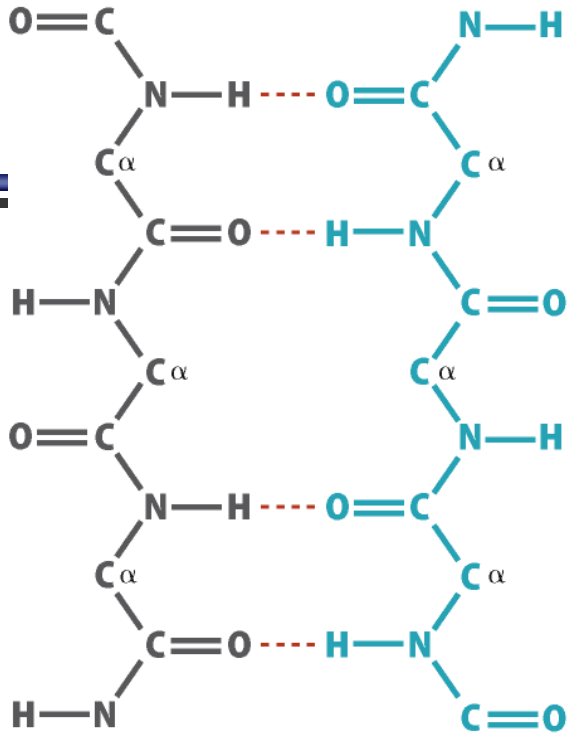
## Parallel $\beta$ sheet

Top view

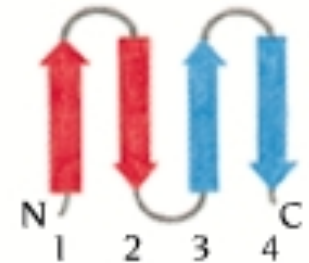
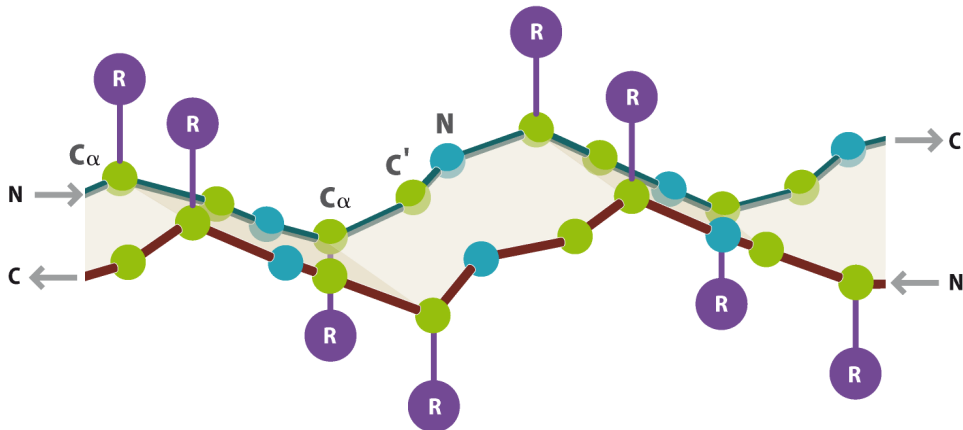
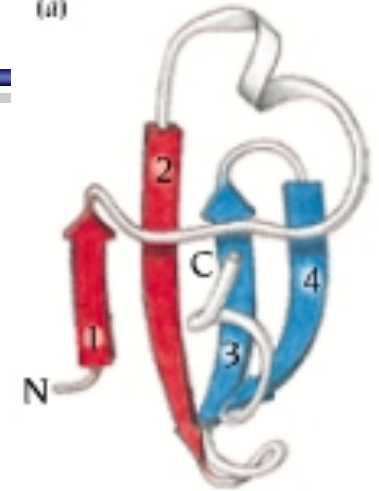


# Antiparallel $\beta$ -sheets

(a)

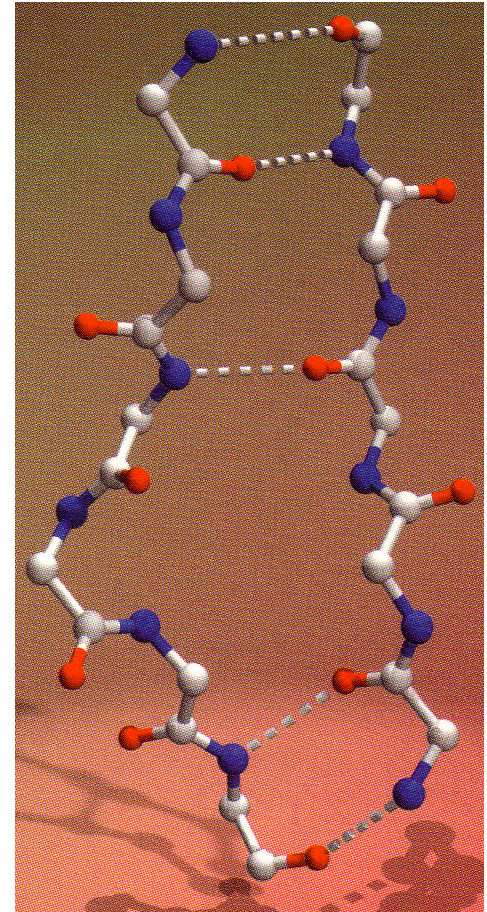


(a)



# The $\beta$ -bulge

- It is an irregularity in the H-bonding pattern of a sheet, where one or two - rarely more - residues deviate from the regular pattern



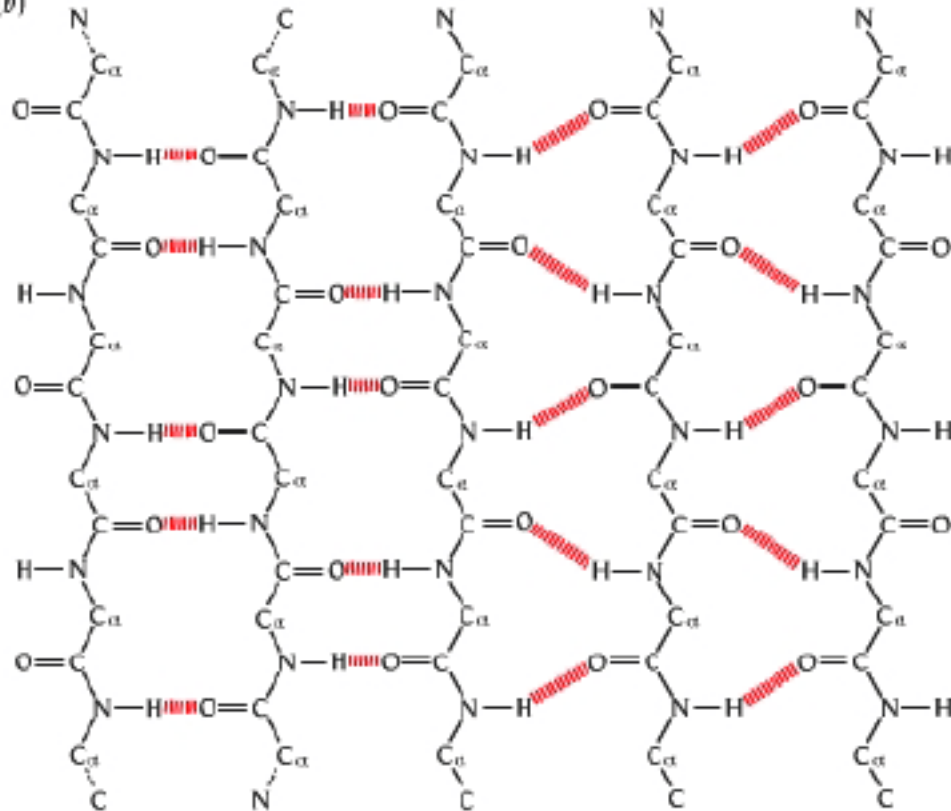
Fab J539  
[2FBJ]

# Mixed $\beta$ -sheets

(a)

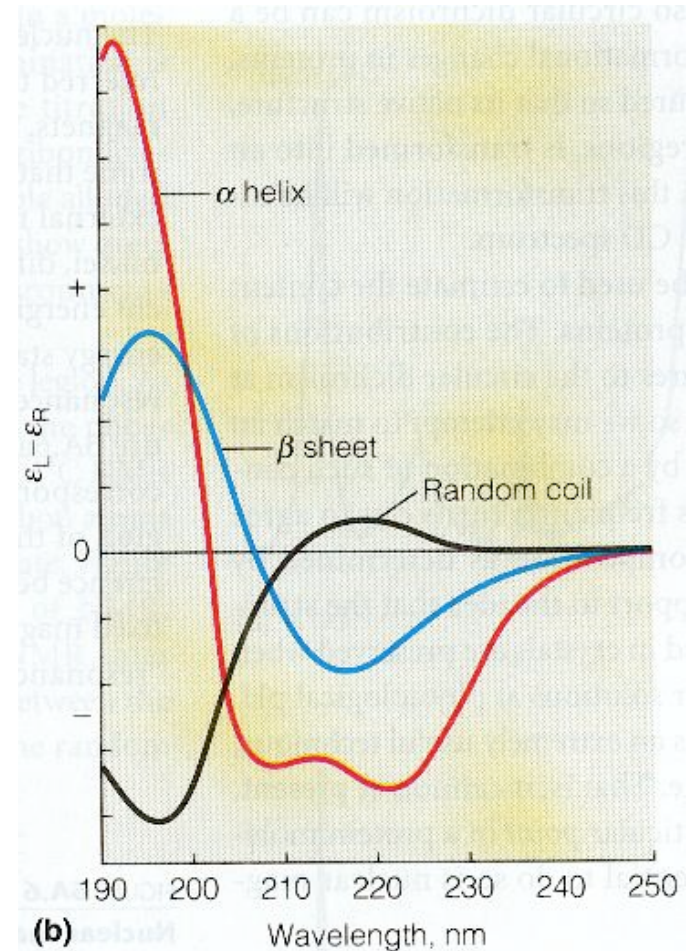
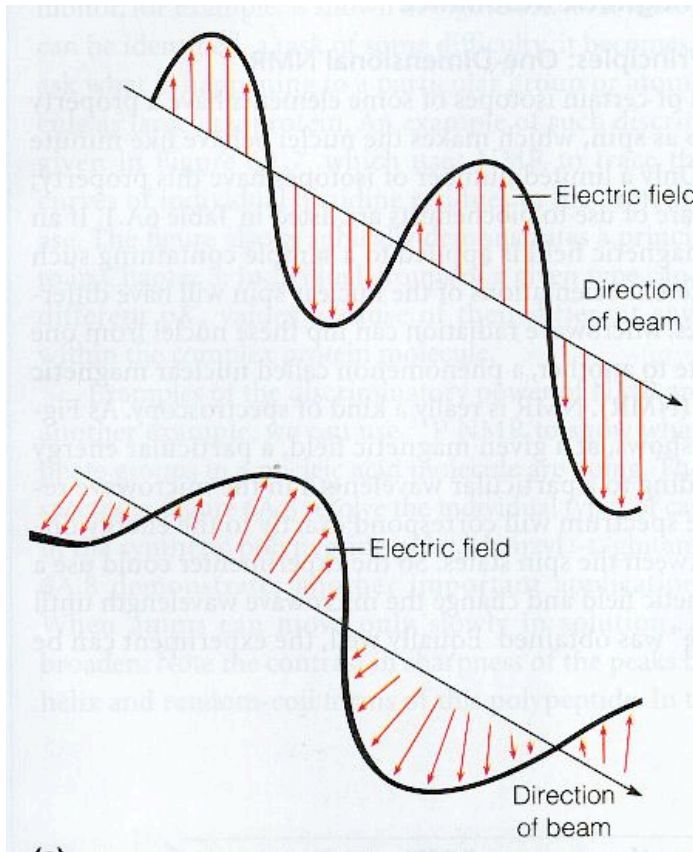


(b)

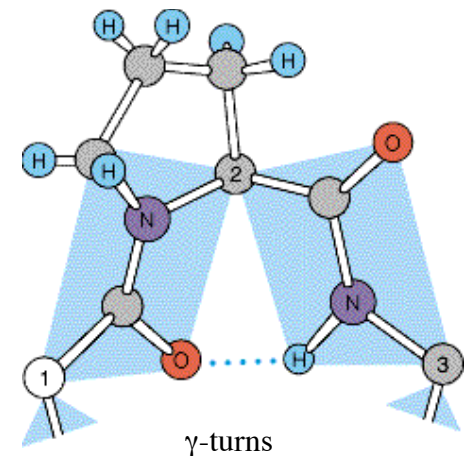
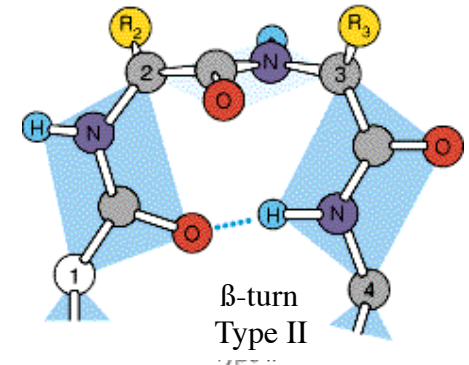
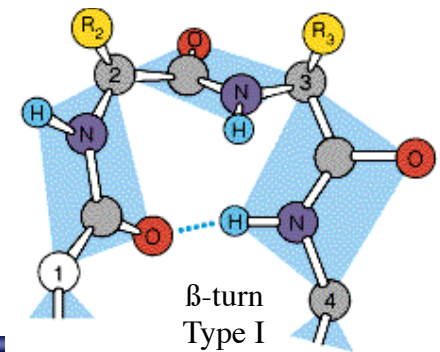


# Study of protein 2ary structure

- Circular dichroism:



- 2.  $\beta$ -sheets are usually twisted or wrapped into barrel structures
- 3. There are different types of turns
  - $\beta$ -turns:
    - Type I: 4 residues where the C=O of residue  $i$  makes H-bond with the N-H of residue ( $i + 3$ ).
    - Type II: same as type I but residue 2 has a bulky R, so residue 3 is a Gly.
  - $\gamma$ -turns:
    - Only 3 residues, of which only 1 is out of the H-bonding sequence. Usually Pro is involved.
- 4. Some parts of proteins cannot be classified as helix,  $\beta$ -sheets or turns: these are 'random coil' regions. Usually are found at the N-ter and C-ter





# Hierarchical nature of protein architecture

---

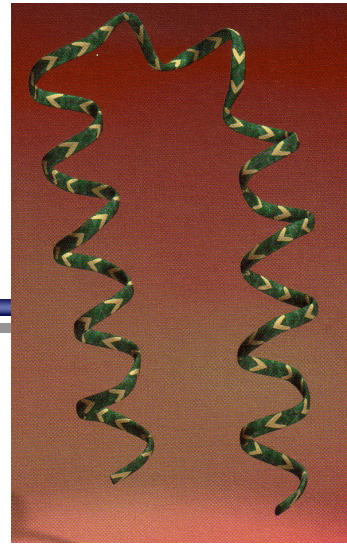
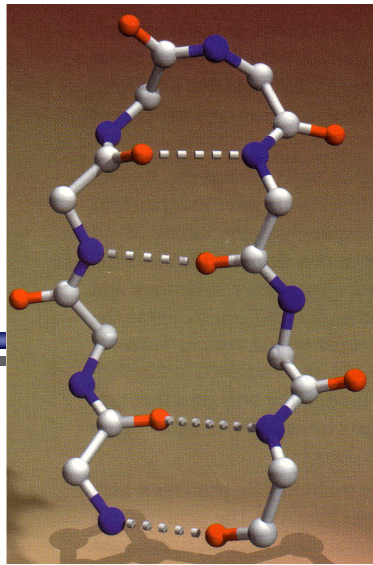
# Levels:

- Linderström-Lang has defined the classical levels of protein structure:
  - I-ary, II-ary, III-ary, IV-ary
- Additional levels have also been introduced:
  - **Super-secondary structure:**
    - These are recurrent patterns of interaction between helices and sheets close together in sequence. Examples are:
      - $\alpha$ -helical hairpin
      - $\beta$ -hairpin
      - $\beta$ - $\alpha$ - $\beta$  unit
      - Coiled-coil
  - **Domains:**
    - These are compact units that fold independently; they are really boarded-line with III-ary structure
  - **Modular proteins:**
    - These are multi-domains proteins where there are domains repeating themselves. One example is fibronectin, an extracellular protein involved in cell-adhesion formed by repeats of 3 identical domains, F1, F2 and F3 in the form of  $(F1)_6(F2)_2(F1)_3(F3)_{15}(F1)_3$

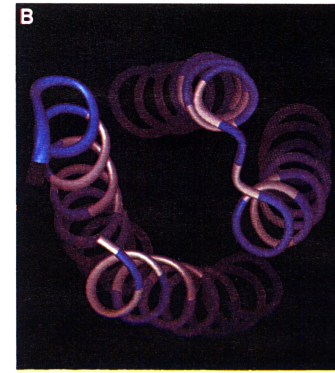
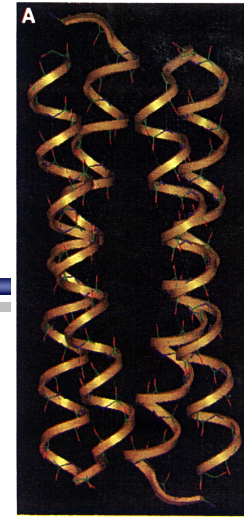




$\beta$ -hairpin

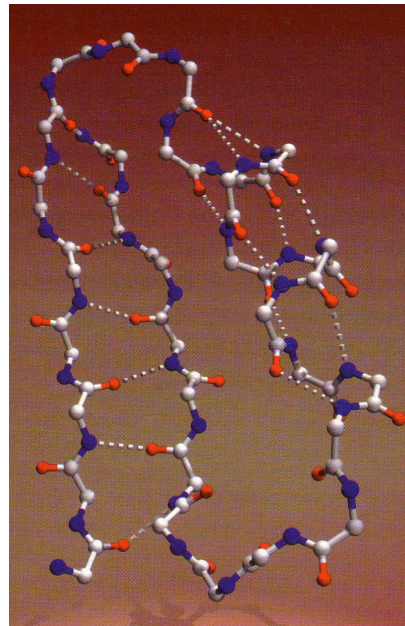


$\alpha$ -helical hairpin

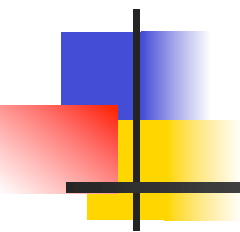


**Figure 2.** Two views of the ROP homodimer illustrating the importance of amphiphilic secondary structure (60). *A*) All backbone atoms are shown and the hydrogen bonds between them are shown as dotted lines. *B*) A view of ROP along the helical bundle axis. The ribbon is colored blue at the positions where hydrophilic residues occur (Ser, Thr, His, Gln, Asn, Lys, Asp, Glu, Arg) and white where hydrophobic residues occur (Phe, Leu, Ile, Met, Val, Ala, Tyr, Cys). This view also reveals the supercoiling of the helices.

coiled coil



$\beta$ - $\alpha$ - $\beta$  unit



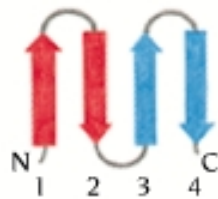
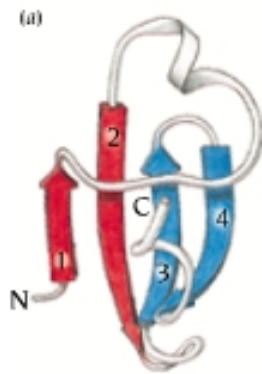
# Classification of protein structures

---

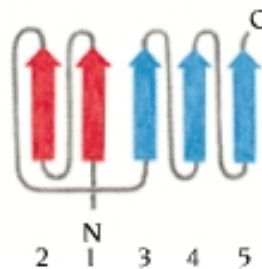
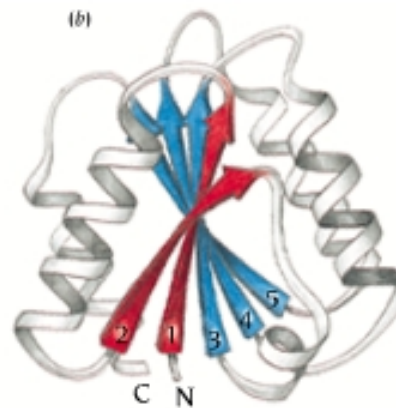
TOPOLOGY

# Topology diagrams

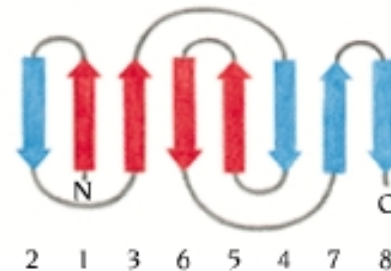
- Useful for classification of protein structures



Aspartate  
transcarbamoylase



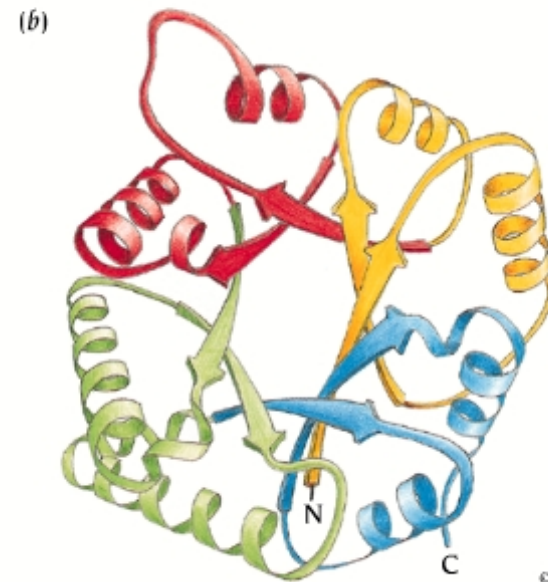
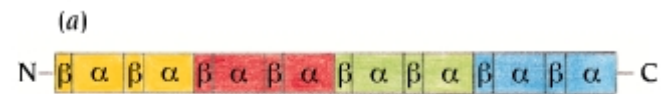
Flavodoxin



Plastocyanin  
©1995 JOHN WILEY & SONS, INC.  
A member of the Taylor & Francis Group

# Domains are built from structural motifs

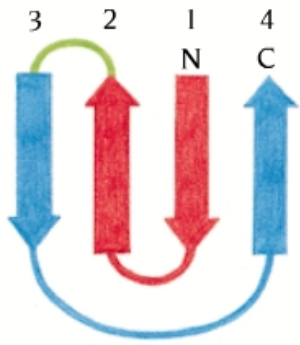
- Triose phosphate isomerase is built from 4  $\beta$ - $\alpha$ - $\beta$ - $\alpha$  motifs



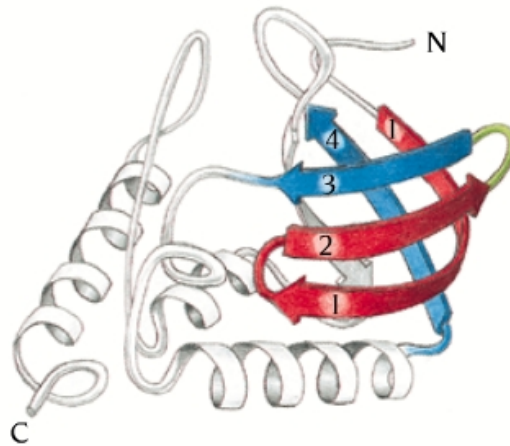
TIM  
barrel

# The Greek key motif

- 4 adjacent antiparallel  $\beta$ -strands (2  $\beta$ -hairpins) are frequently arranged in the so-called Greek key



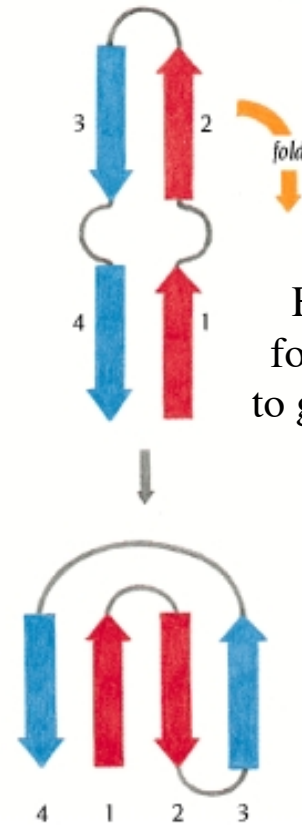
(a)



(b)

*Staphylococcus nuclease*

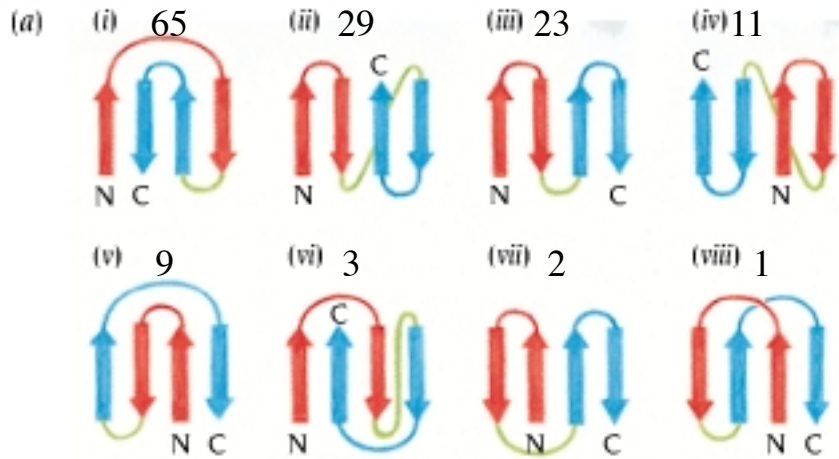
©1999 GARLAND PUBLISHING INC.  
A member of the Taylor & Francis Group



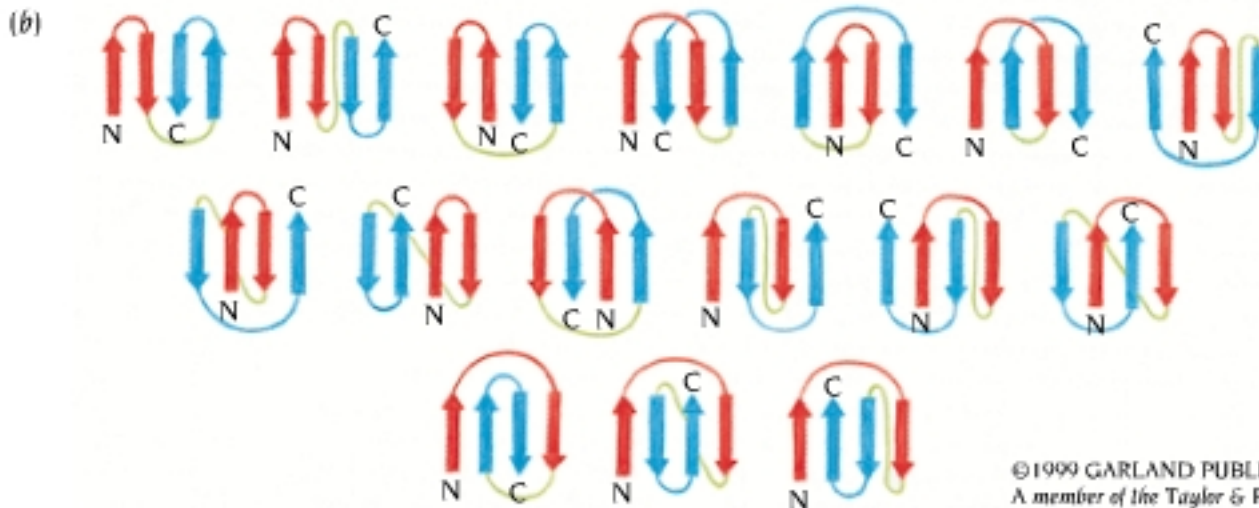
Folding pathway  
for the 2  $\beta$ -hairpins  
to give the Greek key

©1999 GARLAND PUBLISHING INC.  
A member of the Taylor & Francis Group

# Simple motifs combine to form complex motifs



- 2 adjacent  $\beta$ -hairpins can combine in 24 possible ways.



# Protein domains can be divided in 3 main classes

---

- According to Michael Levitt and Cyrus Chothia the taxonomy of protein structures comprehends 3 main groups:
  - $\alpha$ -domains
  - $\beta$ -domains
  - $\alpha/\beta$ -domains

# Proteins can be broadly classified as:

---

- Fibrous = structural - have only II-ary structure
  - Keratins
  - Fibroin
  - Collagen
  - Elastin
- Globular = functional (enzymes, Ab etc) - also have III-ary structure
  - Myoglobin
  - Hemoglobin
  - Cyt c





# Proteins: Tertiary Structure

---

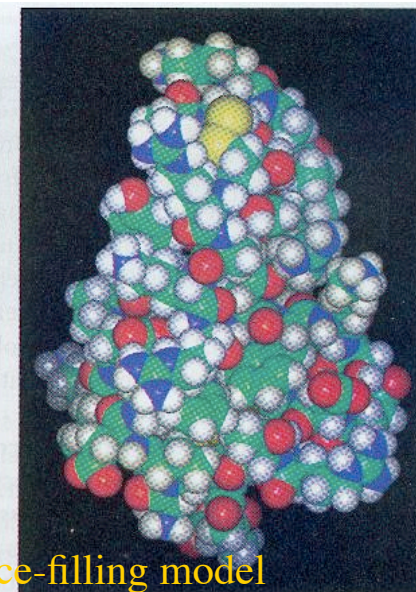
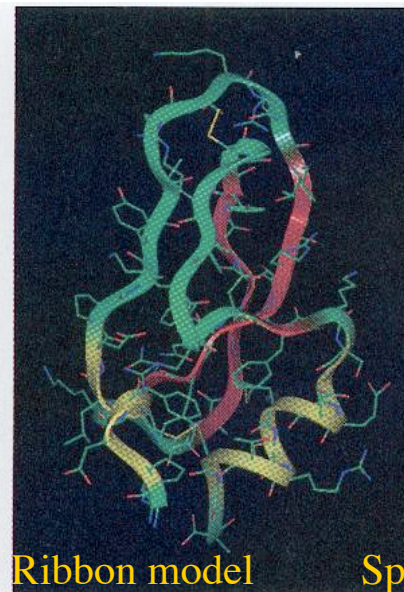
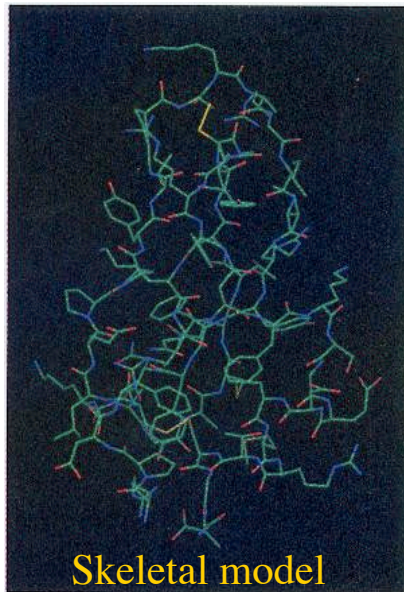
# Globular proteins

- Perform different functions:
  - Synthesis
  - Binding and Transport
  - Catalysis and Metabolism
- They are compact structures folded on themselves
- Different ways to show/study/display proteins

## Bovin Pancreatic Trypsin Inhibitor BPTI

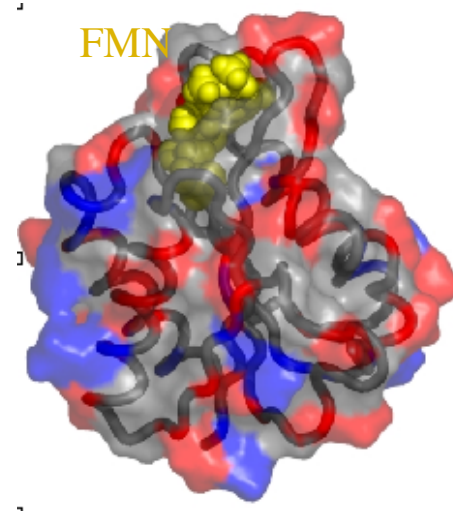
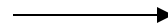
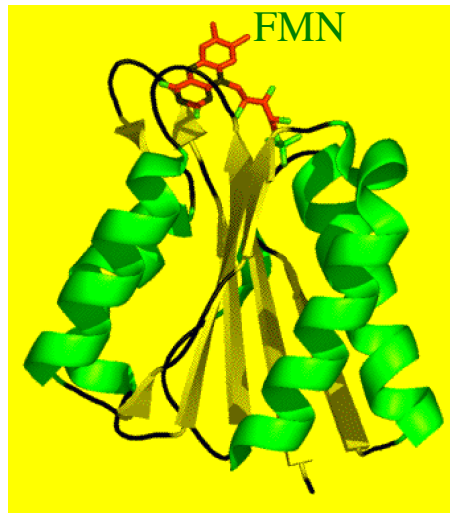
58 aa

Prevents trypsin  
from catalysing  
peptide hydrolysis



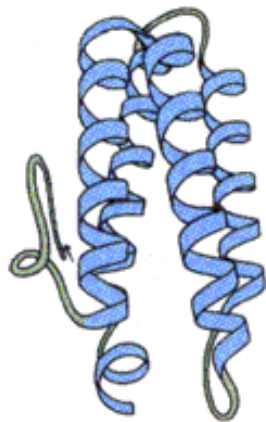
# Other examples

- Many proteins have a prosthetic groups
  - These are small molecules non-covalently or covalently bound to the protein to enable function - for example redox centres:

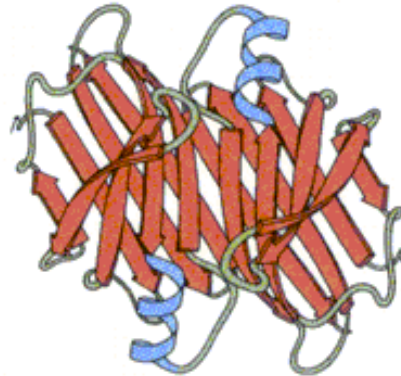


Flavodoxin

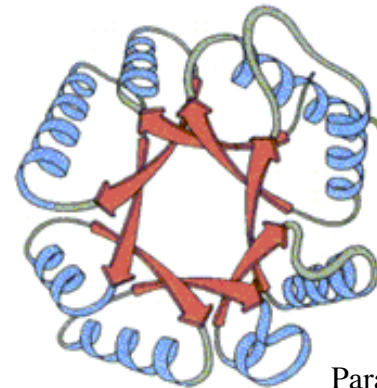
# Varieties of protein folds



Myohemerythrin

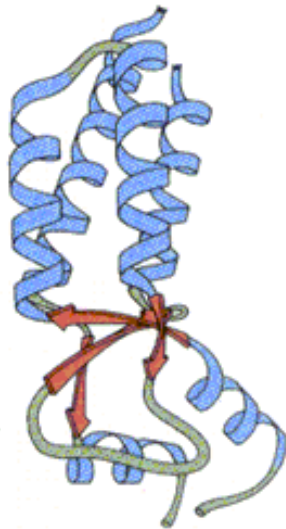


$\beta$  sandwich  
Prealbumin

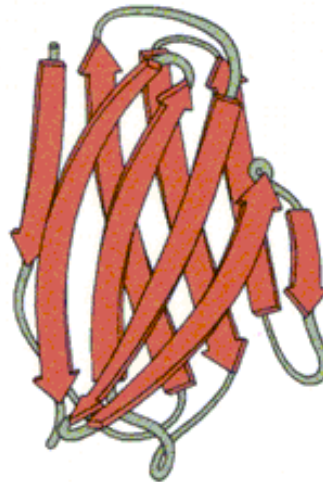


Pyruvate kinase, domain 1

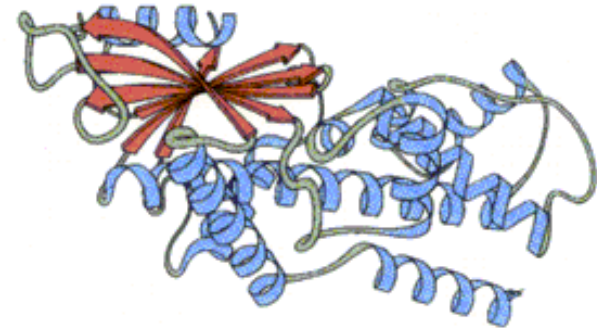
Parallel  $\beta$  barrel



Tobacco mosaic coat protein



Antiparallel  $\beta$  barrel  
Immunoglobulin, V<sub>2</sub> domain



Hexokinase, domain 2

Twisted  $\beta$  sheet

**Helix bundles**

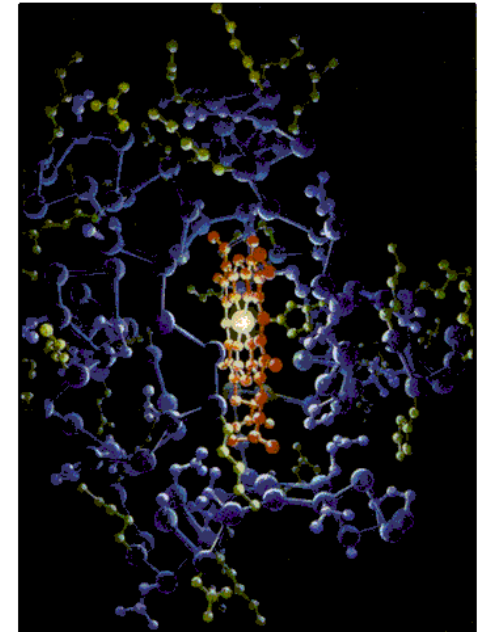
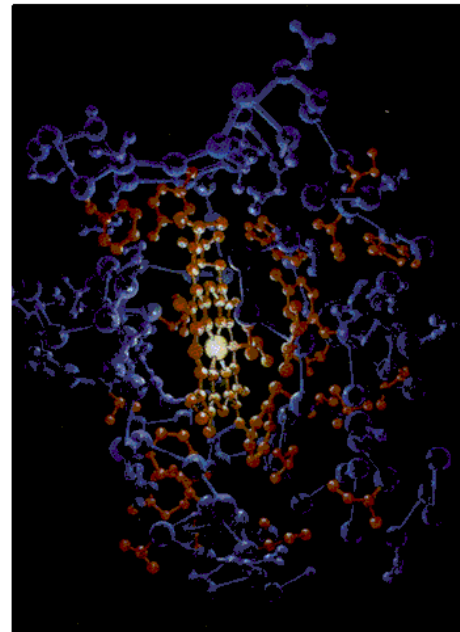
**Predominantly  $\beta$  sheet**

**Mixed  $\alpha/\beta$**

# Rules for 3ary folds

- 1. All globular proteins have a define “inside” and “outside”
  - Hydrophilic (green) versus hydrophobic (red)

1 10 20 30 40 50  
GCVKGGKKLPMQKCAQCHTWEKGGKHKHTGPNLHGLETGRKGTQAPGRTTDT  
ANKNKGITWKEETLMEYLENPKKYIPGTKLIFAGKKKTEREDLAILKKAATNE  
60 70 80 90 100  
(a)



Horse heart cytochrome c