

Ionotropic glutamate receptors (iGluRs)

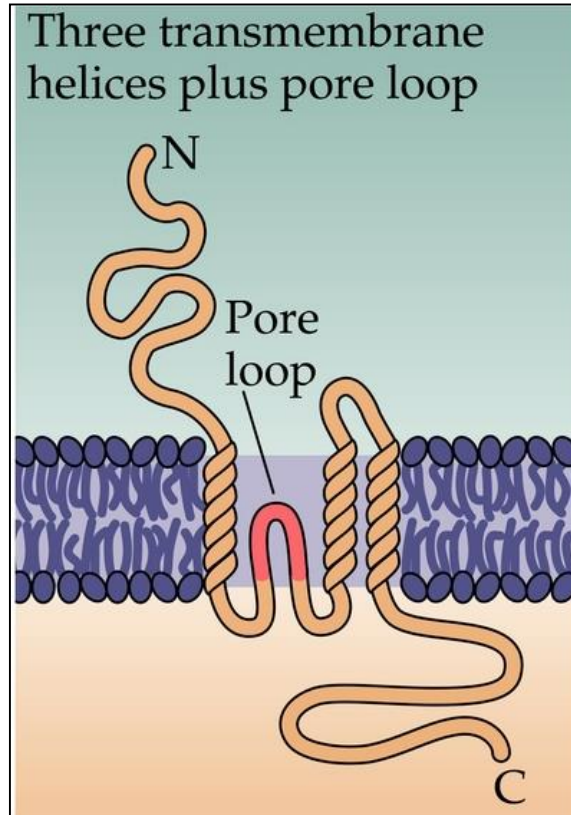

The general architecture of receptor subunits

AMPA	NMDA	Kainate
GluA1	GluN1	GluK1
GluA2	GluN2A	GluK2
GluA3	GluN2B	GluK3
GluA4	GluN2C	GluK4
	GluN2D	GluK5
	GluN3A	
	GluN3B	

Unique properties of iGLU receptors are determined by assembly of different subunits

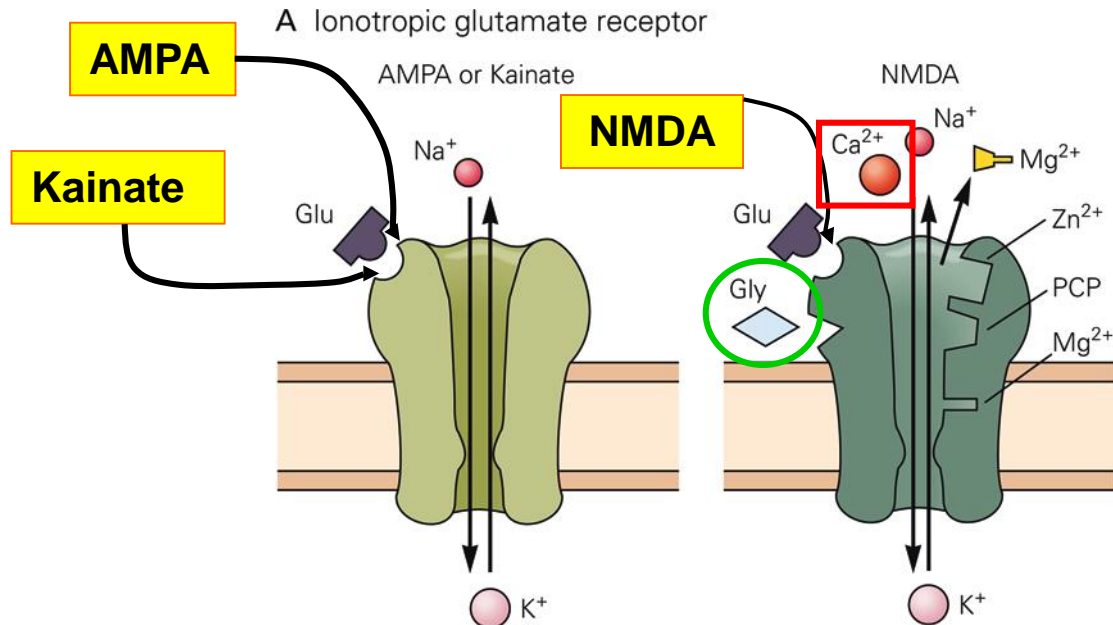

Figure 10-4 Different classes of glutamate receptors regulate excitatory synaptic actions in neurons in the spinal cord and brain.

A. Three classes of ionotropic glutamate receptors directly gate ion channels permeable to cations. The AMPA and kainate type of receptors bind the glutamate agonists AMPA or kainate, respectively. These receptors contain a channel that is permeable to Na⁺ and K⁺. The NMDA receptor, which binds the glutamate agonist NMDA, contains a channel permeable to Ca²⁺, K⁺, and Na⁺. It has binding sites for glutamate, glycine, Zn²⁺, phencyclidine (PCP, or *angel dust*), MK801 (an experimental drug), and Mg²⁺, each of which regulates the functioning of the channel differently.

NMDA glutamate receptors are *calcium-permeable*

However, AMPA-kainate glutamate receptors may also be calcium permeable, depending on the molecular structure...

AMPA receptors are Ca²⁺-permeable?

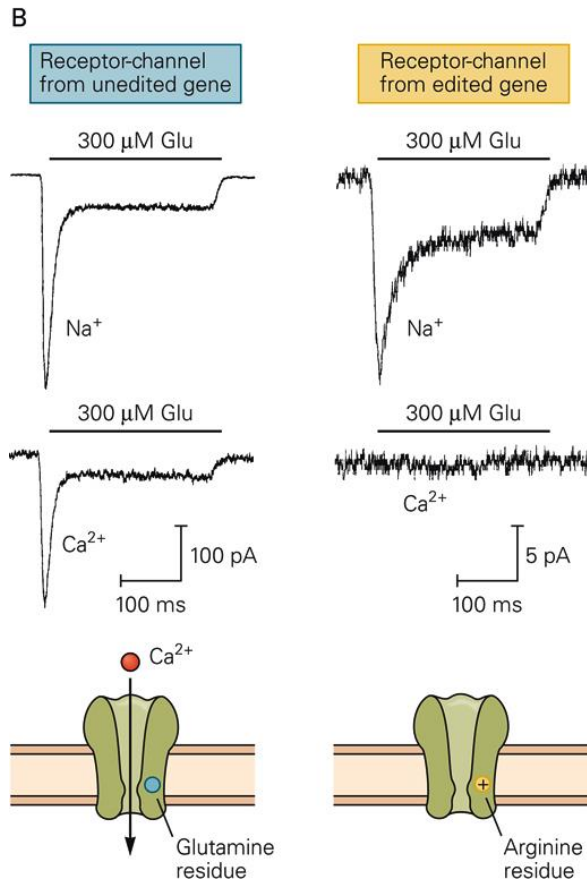
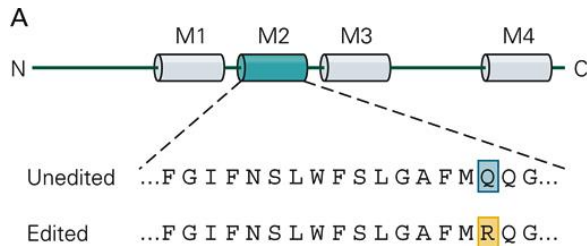

The glutamine residue (Q) present in the M2 segment (transmembrane loop) of AMPAR subunits confers Ca²⁺-permeability.

However, in the **GluA2 subunit**, usually Q is substituted with R (arginine) by RNA editing, making the channel unpermeable to Ca²⁺.

GluA2 subunits are present in most AMPAR assemblies, therefore AMPARs are mostly unpermeable to Ca²⁺

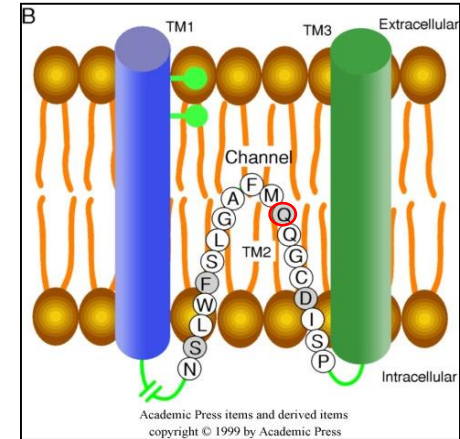
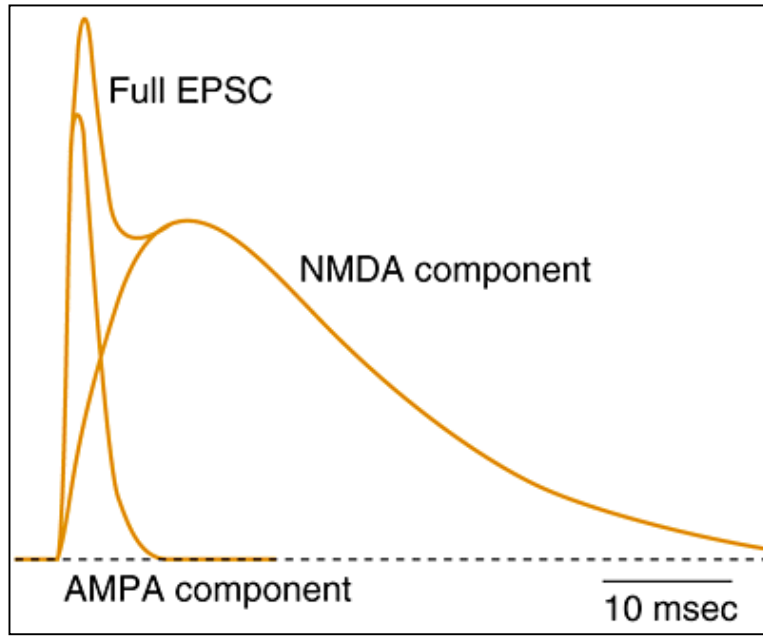

Figure 10-9 Determinants of Ca²⁺ permeability of the AMPA receptor.

A. Comparison of amino acid sequences in the M2 region of the AMPA receptor-channel coded by unedited and edited transcripts of the *GluA2* gene. The unedited transcript codes for the polar residue glutamine (Q, using the single-letter amino acid notation), whereas the edited transcript codes for the positively charged residue arginine (R). In the adult the GluA2 protein exists almost exclusively in the edited form.

B. AMPA receptor-channels expressed from unedited transcripts conduct Ca²⁺ (left traces), whereas those expressed from edited transcripts do not (right traces). The top and bottom traces show currents elicited by glutamate with either extracellular Na⁺ (top traces) or Ca²⁺ (bottom traces) as the predominant permeant cation. (Reproduced, with permission, from Sakmann 1992.)

Excitatory postsynaptic potentials at glutamatergic synapses are characterized by two components: a fast one (AMPA-R) and a slower one (NMDA-R)



Excitatory postsynaptic currents (EPSCs) of hippocampal neurons are comprised of both AMPA- and NMDA-receptor components. Treatment with the NMDA receptor blocker D-2-amino-5-phosphonopentanoic acid (D-AP5) or the AMPA receptor antagonist 6-nitro 7-sulfamobenzo[f] quinoxaline-2,3-dione (NBQX) reveals the other component in isolation, as shown. The EPSC is composed of a brief AMPA receptor component and a more prolonged NMDA component.

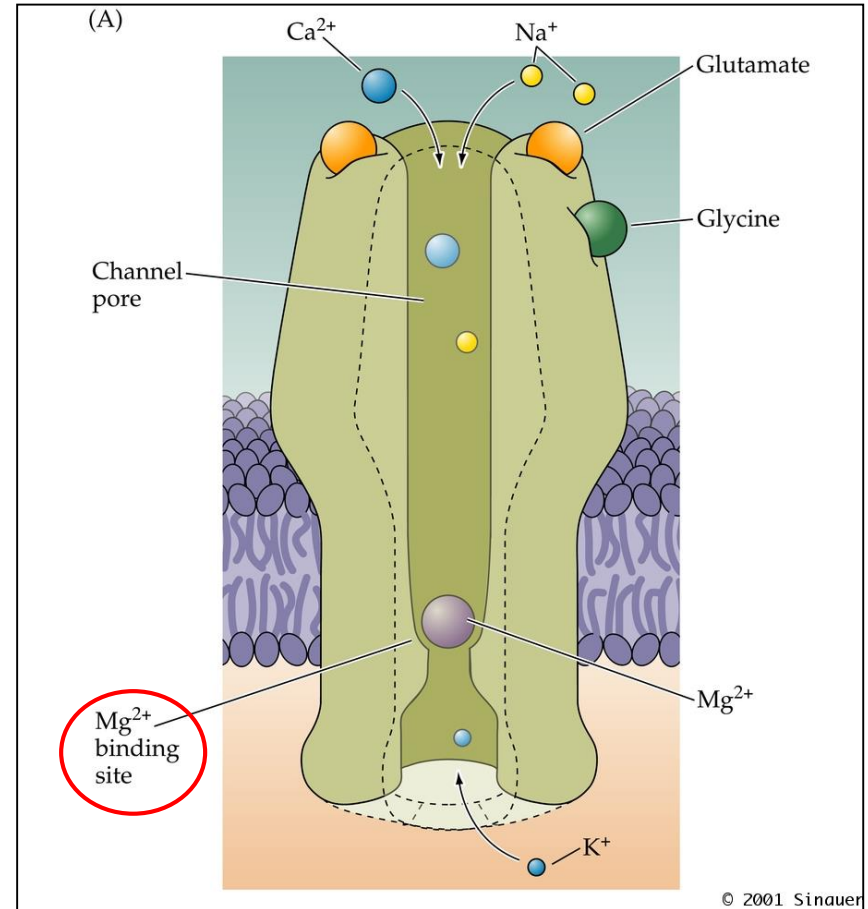

NMDA receptor

NMDA receptors contain binding sites for glutamate and the co-activator glycine, as well as an Mg^{2+} -binding site in the pore of the channel. At hyperpolarized potentials, the electrical driving force on Mg^{2+} drives this ion into the pore of the receptor and blocks it. (B) Current flow across NMDA receptors at a range of

NMDA receptor activation is both ligand- and voltage-dependent

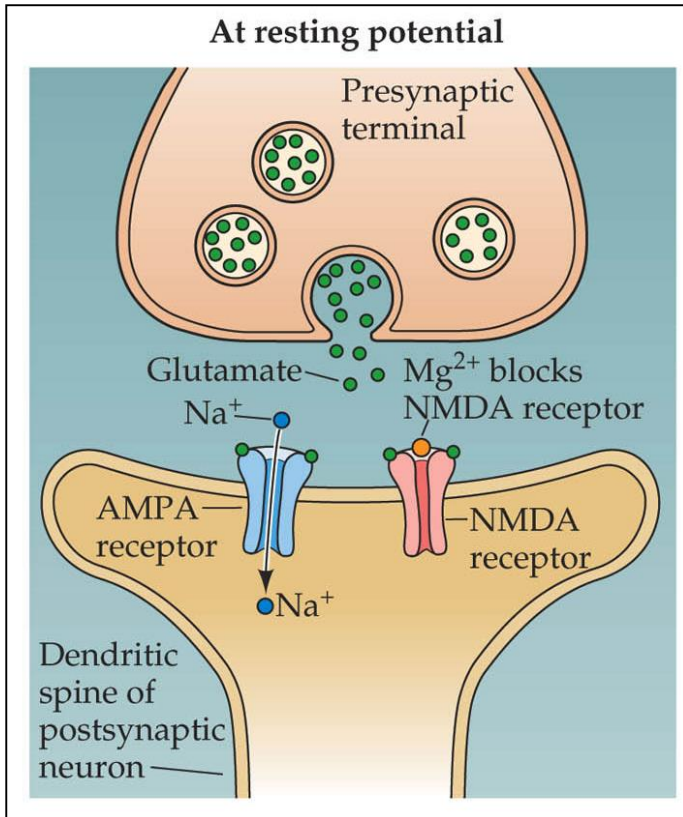

When the postsynaptic membrane is at its normal resting potential, glutamate release will only activate AMPA receptors

NMDA channel blocked by magnesium

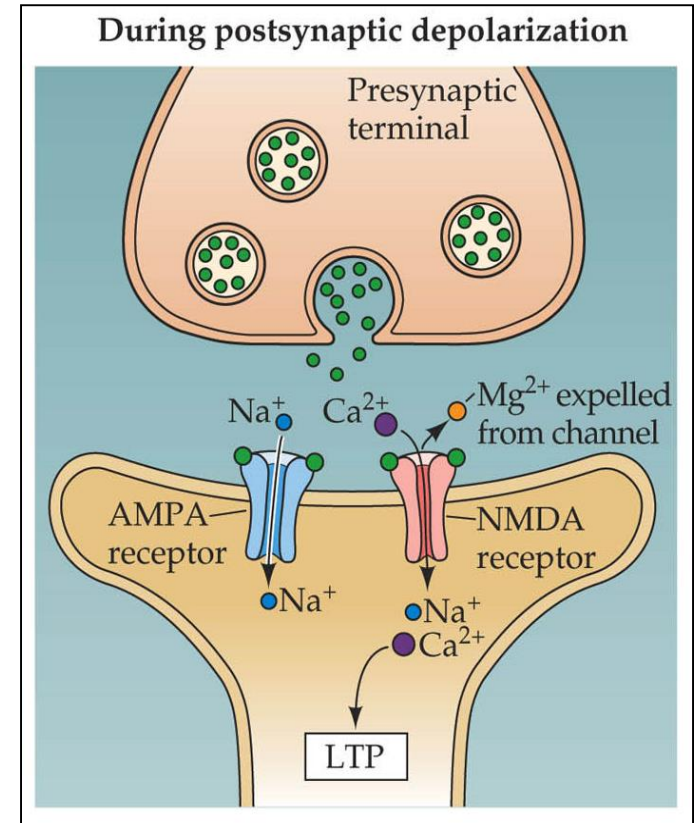

The NMDA channel opens only when the postsynaptic membrane is depolarized

Magnesium expelled from the NMDA channel allows Ca^{++} entry

Silent Synapses

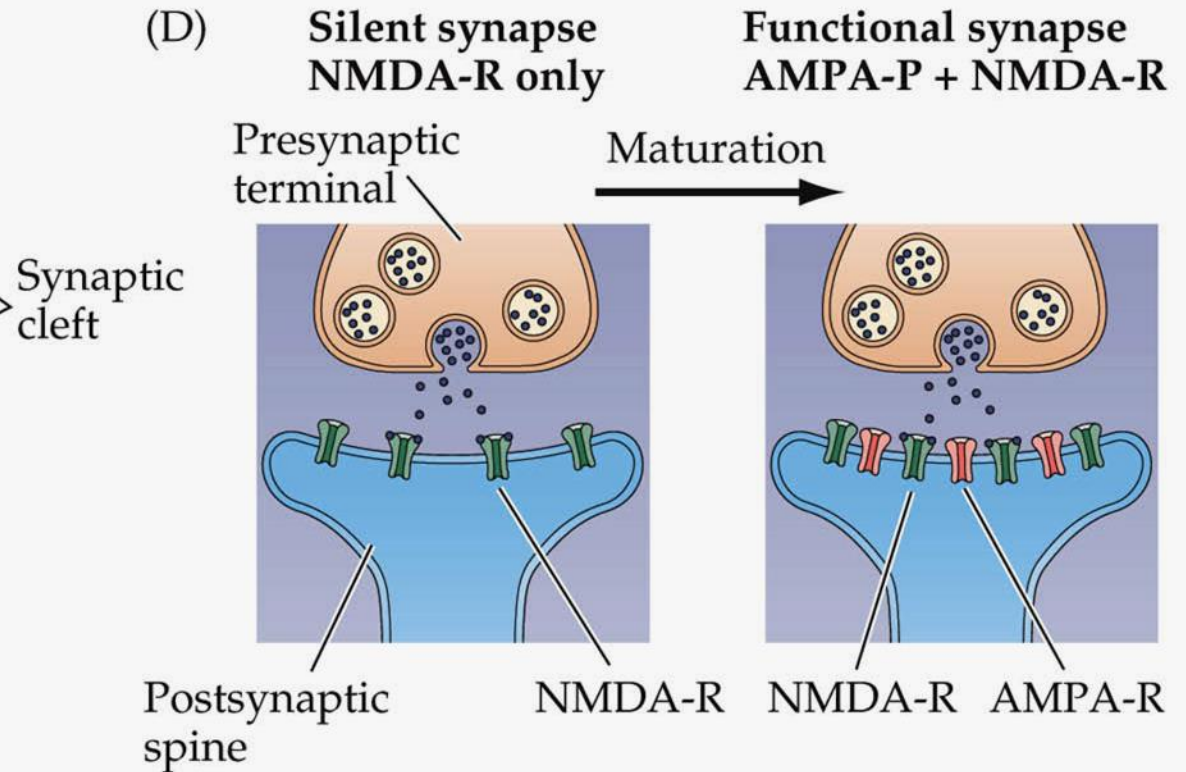
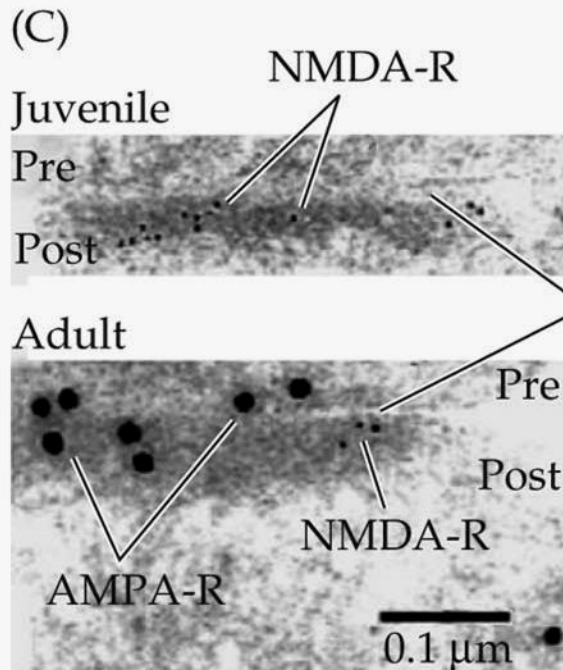

Receptor trafficking and synaptic plasticity

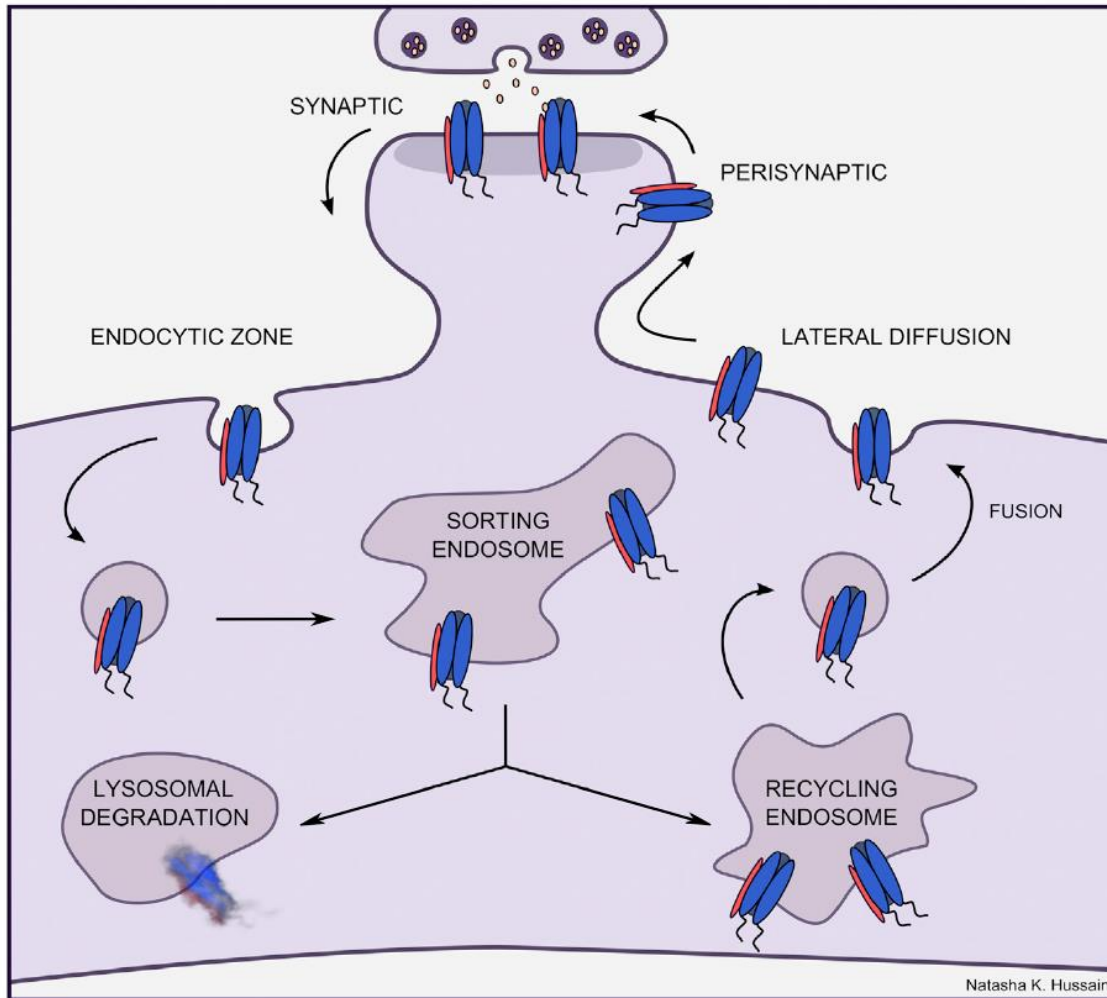
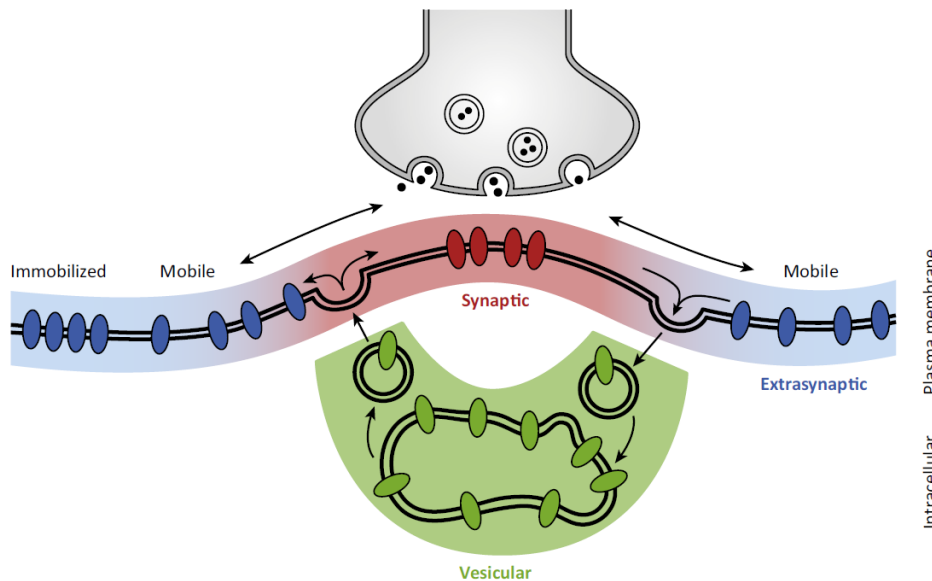

Figure 2. Dynamic AMPAR Trafficking during Synaptic Plasticity

AMPA receptors are now known to rapidly traffic between membrane compartments and to be highly mobile within the plasma membrane. Receptors rapidly move laterally in the extrasynaptic plasma membrane and can enter and exit synapses where they interact with scaffold proteins within the PSD to immobilize them and concentrate them at the synaptic plasma membrane. The receptors can be endocytosed and then move through endosomal compartments to be sorted for degradation or for recycling back to the plasma membrane. This trafficking is highly regulated during LTP and LTD resulting in increases or decreases in the steady state level of receptors at the synapse. During LTP, receptors from nonsynaptic pools, either from the dendritic shaft plasma membrane or from intracellular pools, are recruited to synapses to potentiate synaptic transmission. In contrast, during LTD, receptors diffuse from the synapse and are then endocytosed and degraded resulting in decreases in synaptic strength.

Neurotransmitter receptor reservoirs at postsynaptic sites



Kneussel and Hausrat, 2016
Trends in Neurosci
<http://dx.doi.org/10.1016/j.tins.2016.01.002>

Table 1. Characteristics of Postsynaptic Neurotransmitter Receptor Reserve Pools

	Endocytic Recycling Pool	Plasma Membrane Pool
<i>Subcellular localization</i>	Intracellular (organelles, vesicles)	Extrasynaptic (cell surface)
<i>Neuronal activity dependent</i>	Yes	Yes
<i>Required for LTP</i>	Yes	Yes
<i>Receptor mobility</i>	Active (motor protein dependent)	Passive (lateral diffusion)
<i>ATP dependent</i>	Yes	No
<i>Driver</i>	MyoVb MyoVI Dynein KIF1C, KIF3, KIF13A, KIF16B	
<i>Diffusion control</i>		Radixin Cholesterol ECM proteins NARP TARP γ -8
<i>Velocity of receptor supply</i>	0.1–0.2 $\mu\text{m/s}$	0.1–0.5 $\mu\text{m}^2/\text{s}$
<i>Synaptic versus reserve pool receptors</i>	12% synaptic 88% intracellular	10% synaptic 90% extrasynaptic
<i>Receptors supplied during LTP</i>	10–30%	70–90%

Molecular mechanisms of the early and late phase of Long Term Potentiation (LTP) at Schaffer collateral-CA1 synapses in the hippocampus

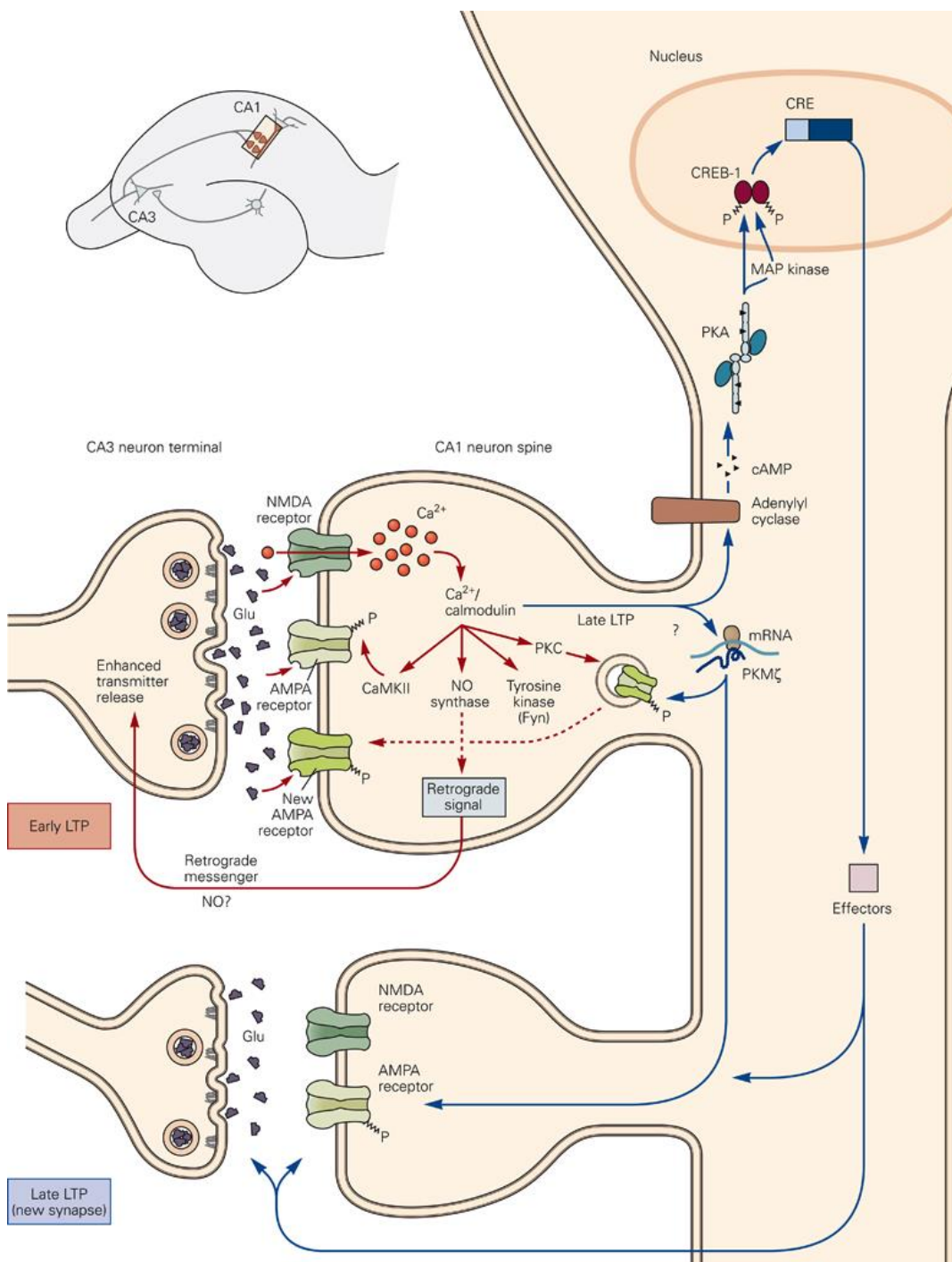
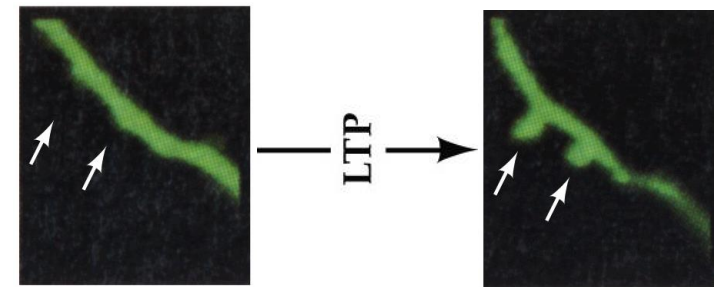

Figure 67-9 A model for the molecular mechanisms of early and late phases of long-term potentiation. A single tetanus induces early LTP by activating NMDA receptors, triggering Ca²⁺ influx into the postsynaptic cell and the activation of a set of second messengers. With repeated tetani the Ca²⁺ influx also recruits an adenylyl cyclase, which generates cAMP that activates PKA. This leads to the activation of MAP kinase, which translocates to the nucleus where it phosphorylates CREB-1. CREB-1 in turn activates transcription of targets (containing the CRE promoter) that are thought to lead to the growth of new synaptic connections. Repeated stimulation also activates translation in the dendrites of mRNA encoding PKMζ, a constitutively active isoform of PKC. This leads to a long-lasting increase in the number of AMPA receptors in the postsynaptic membrane. A retrograde signal, perhaps NO, is thought to diffuse from the postsynaptic cell to the presynaptic terminal to enhance transmitter release.



New dendritic spines (white arrows) can be observed approximately 1 hour after a stimulus that induces LTP

Glutamate-dependent excitotoxicity

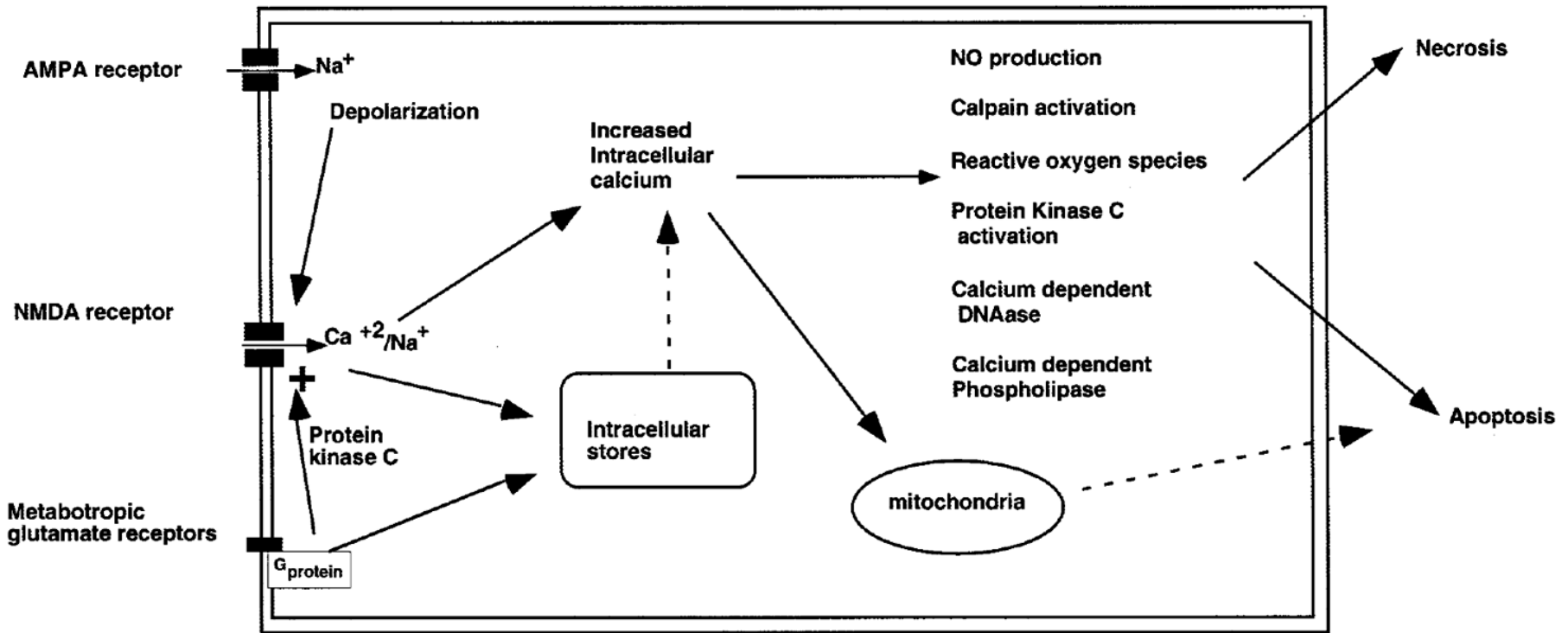
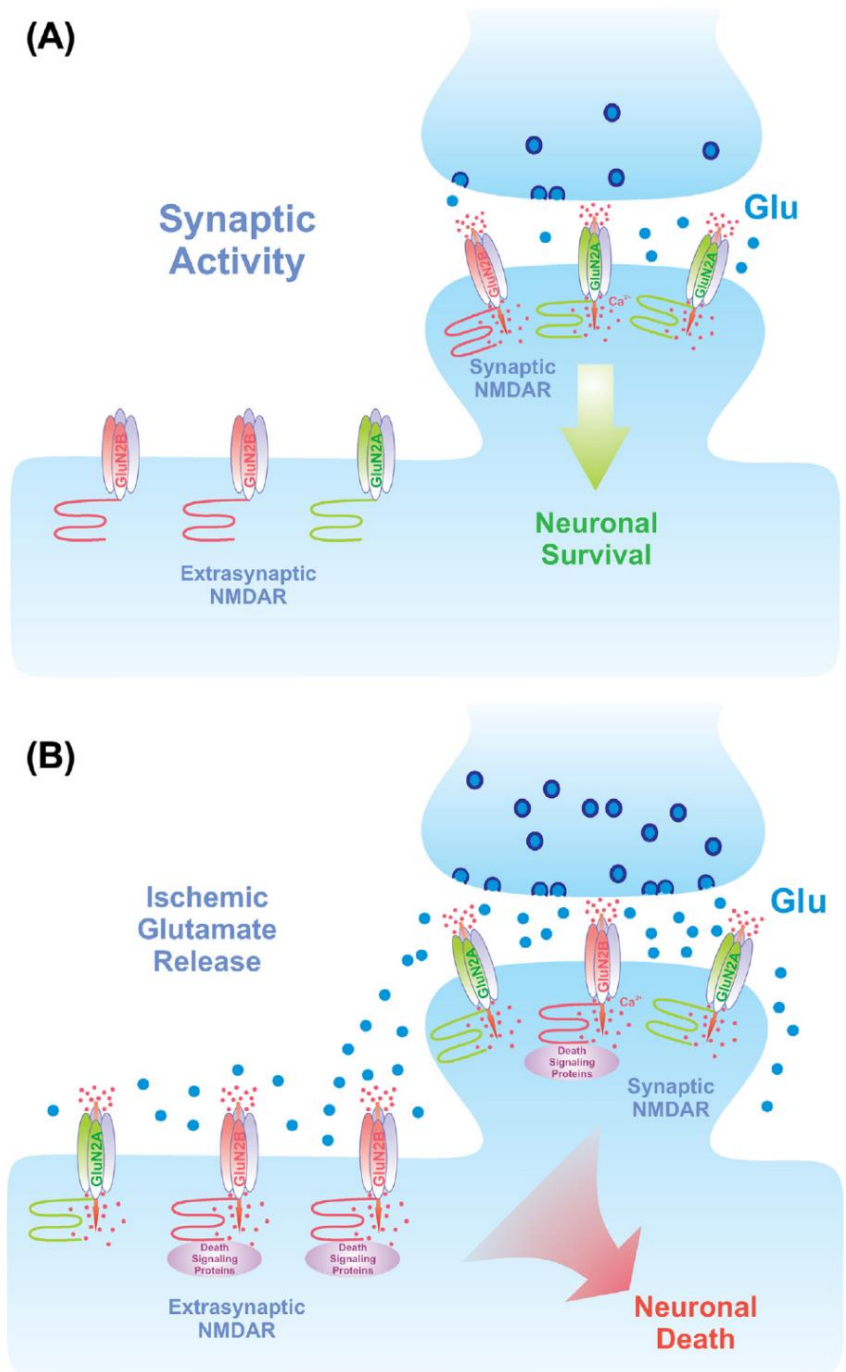

Fig. 1. Excitotoxicity, glutamate receptors, and multiple messenger systems. Glutamate is capable of activating multiple receptor systems. A crucial component of excitotoxicity is mediated through the NMDA receptor, which allows high levels of calcium entry. Such calcium selectively activates a variety of downstream events, many of which are toxic to the cell when excessive levels of activation are reached. Modified from Lynch and Dawson (1994) with permission (Lippincott-Williams and Wilkins).

Glutamate-dependent neuronal survival and death

Distinct subpopulations of the NMDA receptor (NMDAR) mediate neuronal death and survival.

- (a) Under normal conditions, synaptic activity maintains neuronal survival via activation of the **synaptic NMDAR**. This pro-survival effect is dependent on the calcium influx through the receptors.
- (b) During cerebral ischemia, **excessive release of glutamate** into the synapses and **extrasynaptic sites** causes global stimulation of NMDAR at both locations. The C-terminal domain of the GluN2B subunit acts as a major hub for recruiting **death-signaling proteins**, which in turn is activated by calcium influx through the receptors to induce neuronal death.



Neuronal survival via CREB and BDNF

Synaptic activity mediates prolonged neuronal survival via a positive feedback loop between CREB and BDNF. Synaptic activity promotes neuronal survival in part by NMDA receptor (NMDAR)-mediated phosphorylative activation of **cyclic AMP response element (CRE) binding protein (CREB)**. The phosphorylated CREB binds to the CREB-binding protein (CBP) to regulate the transcription of CRE-responsive genes.

One survival gene that is regulated is **brain-derived neurotrophic factor (BDNF)**, and BDNF release mediated by NMDAR stimulation and BDNF activation of the Trk receptor can further promote CREB activation. During cerebral ischemia, **stimulation of the extrasynaptic NMDARs induces a CREB shut-off pathway, leading to neuronal death.**

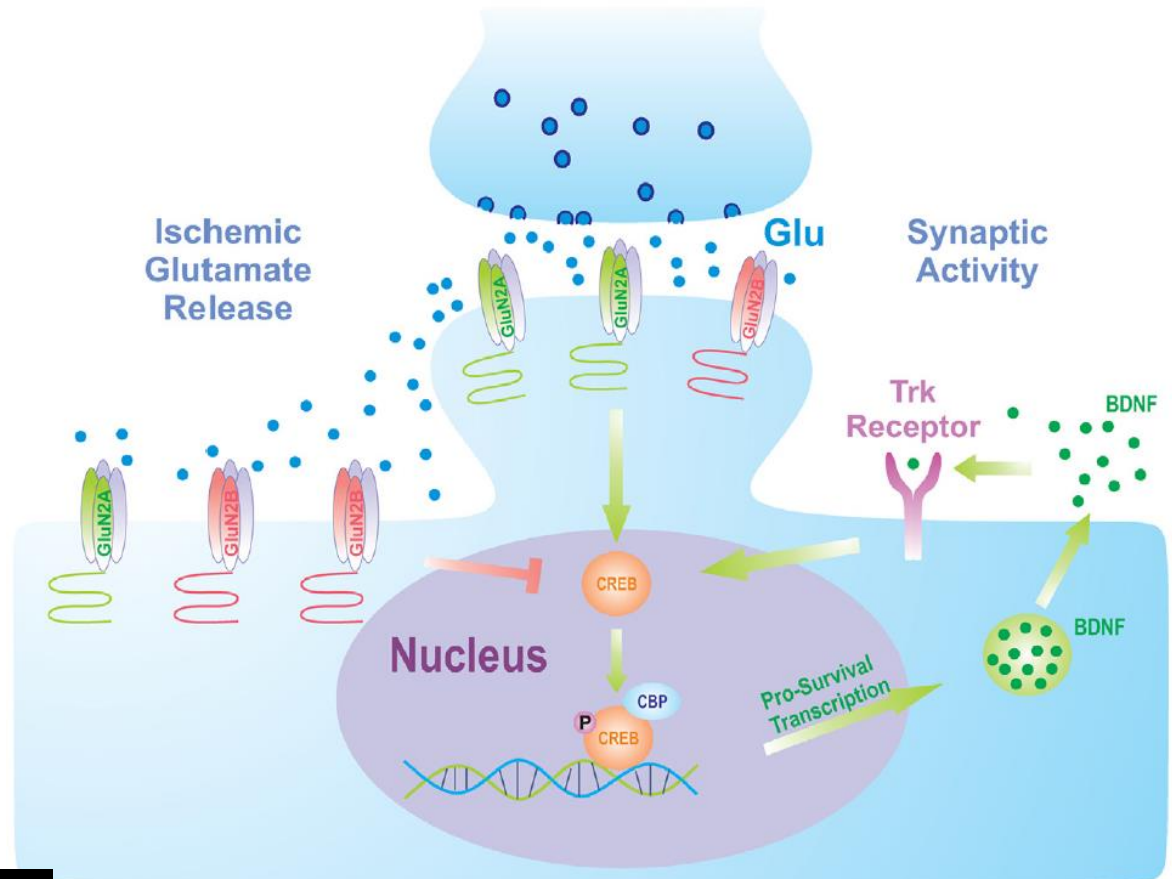

Excitotoxicity recruits death-associated protein kinase 1 (DAPK1) to the cytoplasmic tail of the GluN2B subunit.

During cerebral ischemia, influx of calcium ion through the NMDA receptor (NMDAR) induces calcineurin-mediated dephosphorylation and activation of DAPK1 at serine-308. The activated DAPK1 binds to the C-terminal domain of the GluN2B subunit of NMDAR, and augments the activity of the receptor to promote excitotoxicity. In addition, DAPK1 can be phosphorylated by extracellular signalregulated kinase (ERK) at serine-735, and this phosphorylation induces neuronal death directly by augmenting DAPK1 activity and by hindering the survival-promoting activity of ERK.

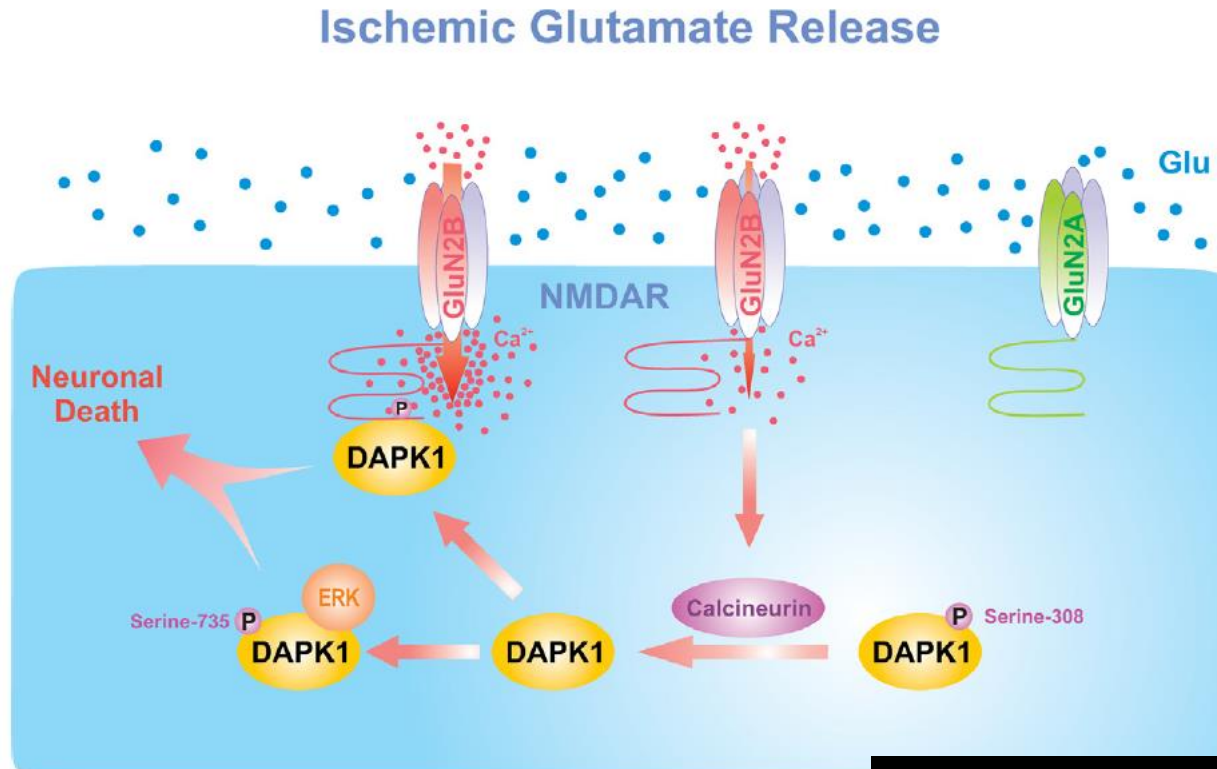

The glutamatergic postsynaptic density (PSD)

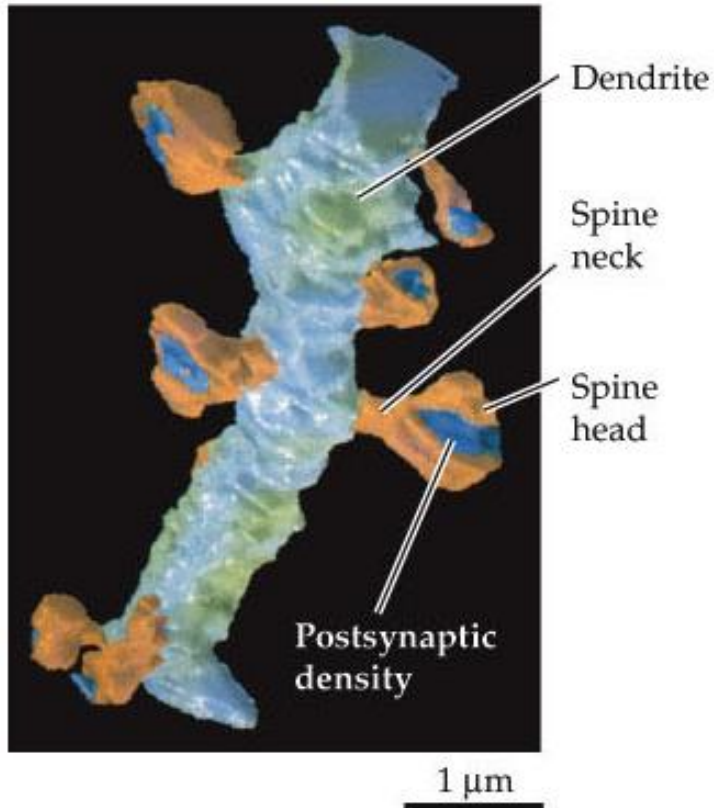

What is the PSD?

- A dense area on tip of spine head, occupying only 10-15% of total spine surface area.
- A membrane disk localizing glutamate receptors, protein kinases, and other signaling molecules associated with plasticity of synapses.
- PSD-95 is the most abundant protein.

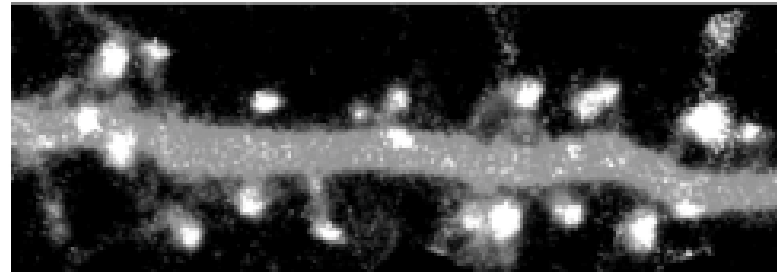

PSD-95 ICC in cultured hippocampal neurons

The molecular postsynaptic composition at central glutamatergic synapses

A Purified postsynaptic densities

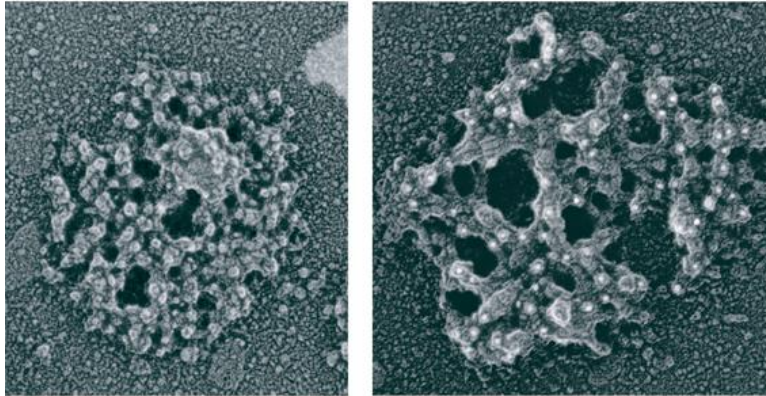

B Distribution of receptors

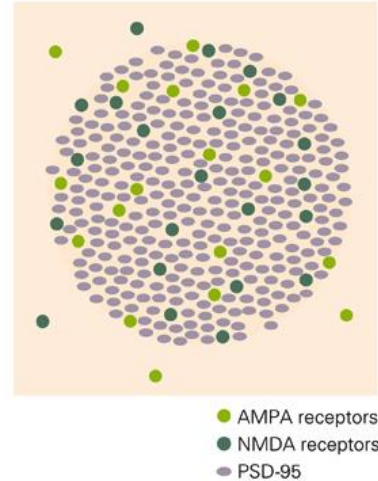

Figure 10-10 The postsynaptic cell membrane is organized into a macromolecular complex at excitatory synapses.

Proteins containing PDZ domains help organize the distribution of AMPA and NMDA receptors of the postsynaptic membrane at the postsynaptic density. (Reproduced, with permission, from Sheng and Hoogenrad 2007. Micrographs originally provided by Thomas S. Reese and Xiaobing Chen, National Institutes of Health, USA.)

A. Electron microscope images of biochemically purified postsynaptic densities, showing organization of protein network. The membrane lipid bilayer is no longer present. **Left:** View of postsynaptic density from what would normally be the outside of the cell. This image consists of the extracellular domains of various receptors and membrane proteins. **Right:** View of a postsynaptic density from what would normally be the cytoplasmic side of the membrane. White dots show immunolabeled guanylate kinase anchoring protein, an important component of the PSD.

B. Schematic view of localization and typical number of NMDA receptors, AMPA receptors, and PSD-95, a prominent postsynaptic density protein, at a synapse.

C. Schematic view of the network of receptors and their interacting proteins in the postsynaptic density. PSD-95 contains three PDZ domains at its amino terminus and two other protein interacting motifs at its carboxyl terminus, an SH3 domain and guanylate kinase (GK) domain. Certain PDZ domains of PSD-95 bind to the carboxyl terminus of the GluN2 subunit of the NMDA receptor. PSD-95 does not directly interact with AMPA receptors but binds to the carboxyl terminus of the TARP family of membrane proteins, which interact with the AMPA receptors as auxiliary subunits. PSD-95 also acts as a scaffold for various cytoplasmic proteins by binding to the guanylate-kinase-associated protein (GKAP), which interacts with Shank, a large protein that associates into a meshwork linking the various components of the postsynaptic density. PSD-95 also interacts with the cytoplasmic region of neuroigin. The metabotropic glutamate receptor is localized on the periphery of the synapse. It interacts with the protein Homer, which in turn binds to Shank.

C Molecular organization of synapse at dendritic spine

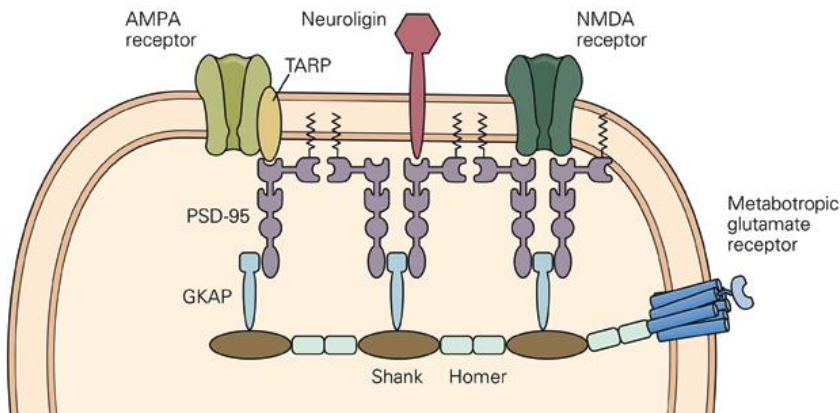

Scaffold molecules in PSD

a Scaffolds

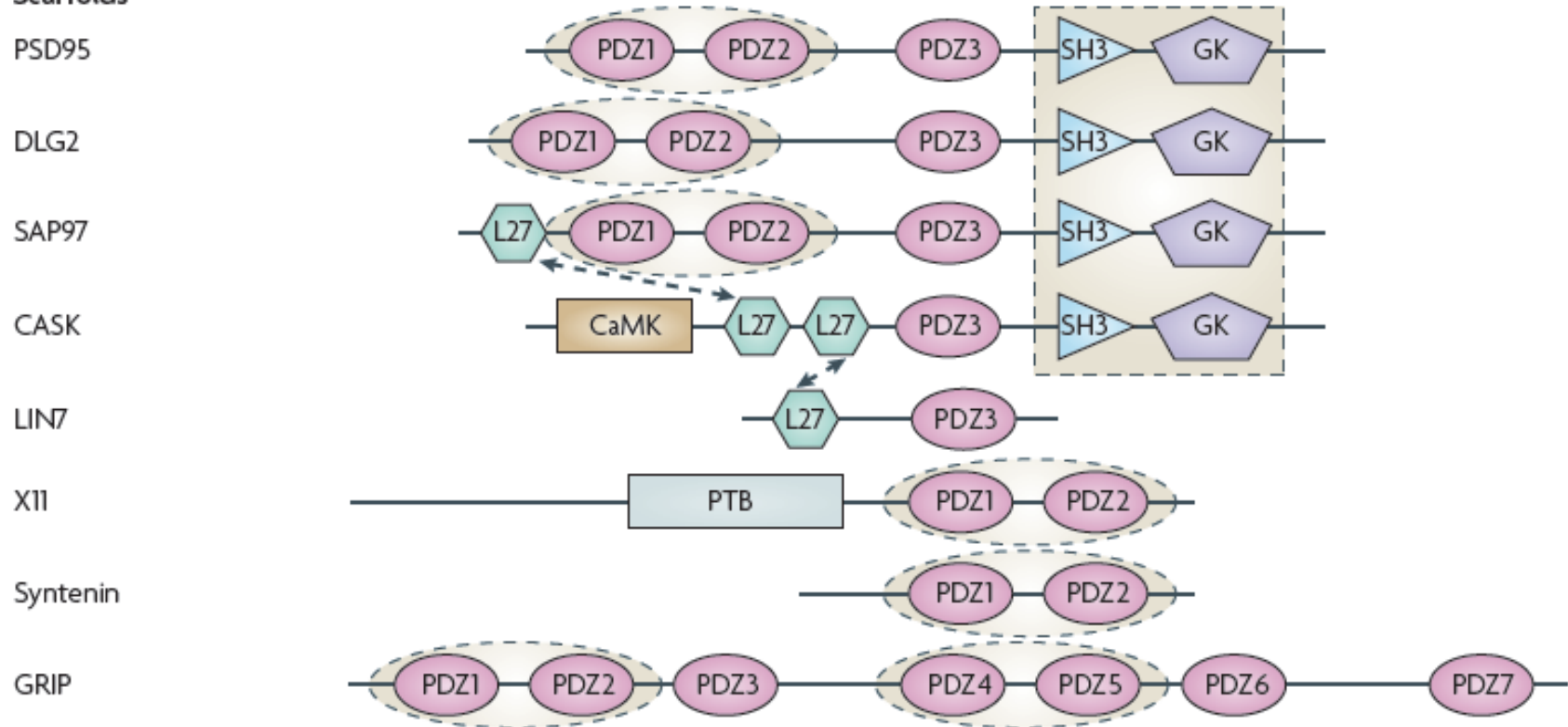

Scaffold proteins are abundant components of the PSD and have been shown to have crucial roles including trafficking, anchoring and clustering of glutamate receptors; linking glutamate receptors with their downstream signalling proteins; organizing multiple components into large signalling complexes; and interfacing with and regulating the dynamics of cytoskeletal structures

The latest view: an orderly organized PSD

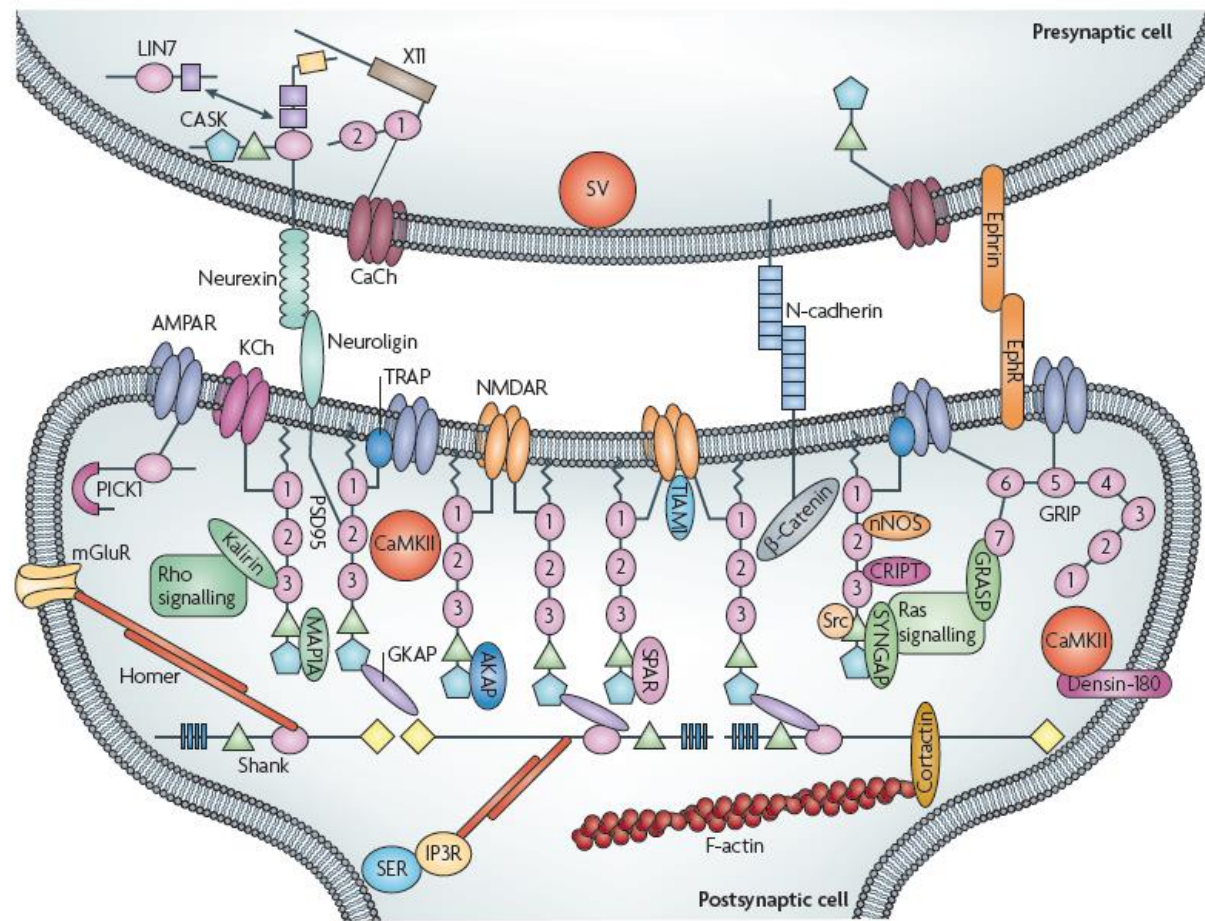

Feng & Zhang, 2009
Nature Reviews Neurosci.
doi:10.1038/nrn2540

The recent advances in high-resolution EM tomography coupled with specific antibody labelling have shown the anatomical structures of PSDs directly: the **first layer** of a PSD mainly contains membrane receptors, ion channels and transmembrane cell-adhesion molecules, with NMDA receptors at the centre and AMPA receptors at the periphery; the **second layer** is enriched with scaffolding proteins (MAGuK proteins, in particular PSD95), which are closely coupled to the membrane receptors and ion channels and are arranged perpendicular to the PSD membrane with their amino-terminal lipids attached to it; the **third layer** is comprised of Shank and guanylate kinase-associated protein (GKAP)-family proteins, which are linked to the carboxy-terminal Src homology 3–guanylate kinase-like (SH3–GK) domains of the MAGuK proteins and are arranged in parallel to the PSD membrane. The proteins in this third layer are further connected to the actin cytoskeleton. All of these membrane receptors and scaffolding proteins form a weblike protein network to which other cytoplasmic PSD proteins and enzymes can bind.