



Electrical properties of cell membranes

Cell excitability. Action potential. Membrane currents measurements by patch clamp technique

MEMBRANE POTENTIAL

All cells present a **different charge distribution** at membrane sides. This generates a **MEMBRANE POTENTIAL DIFFERENCE** between intracellular and extracellular sides.

- The electric charges are due to the presence of ions in the interstitial liquids
- **CATIONS** = ions + (K⁺, Na⁺, Ca²⁺....)
- **ANIONS** = ion - (Cl⁻....)

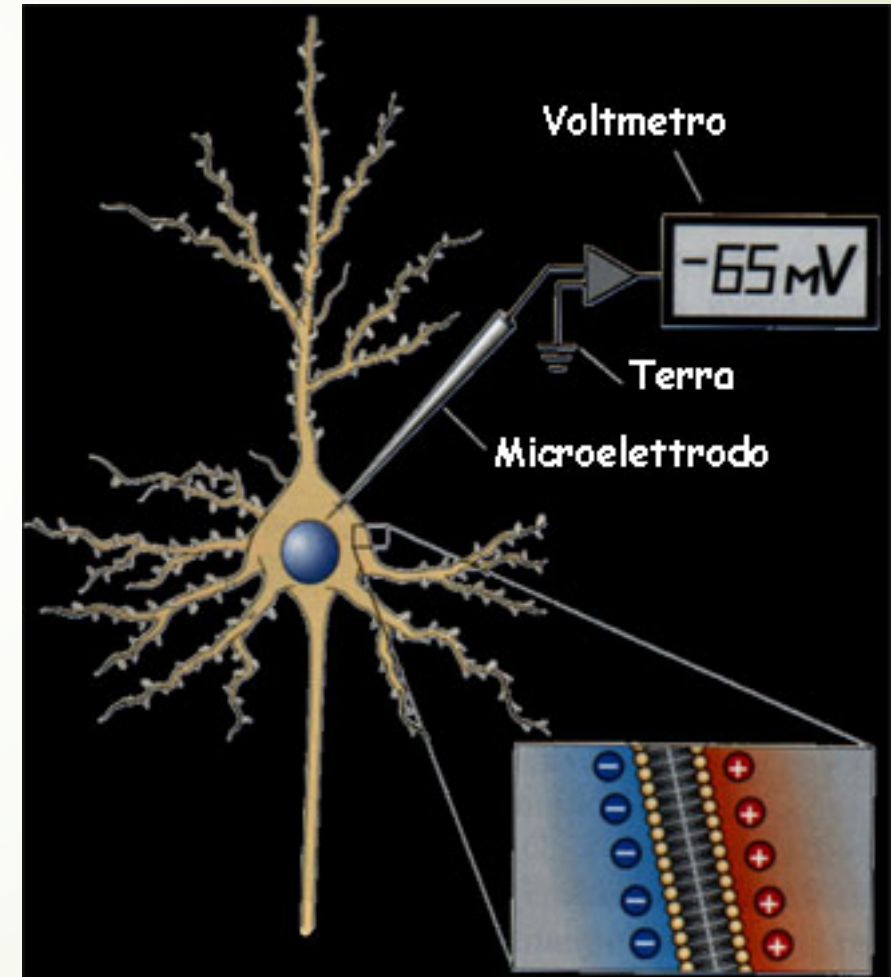

Experimental measure of the Membrane Potential (V_m)

A voltmeter measure the potential difference between intracellular and extracellular compartments. If we set to 0mV the extracellular compartment, we will measure a negative potential inside the cells

➔ In the majority of the cells the intracellular compartment is about 70mV negative as compared with the extracellular solution

➔ $V_m = -70mV$

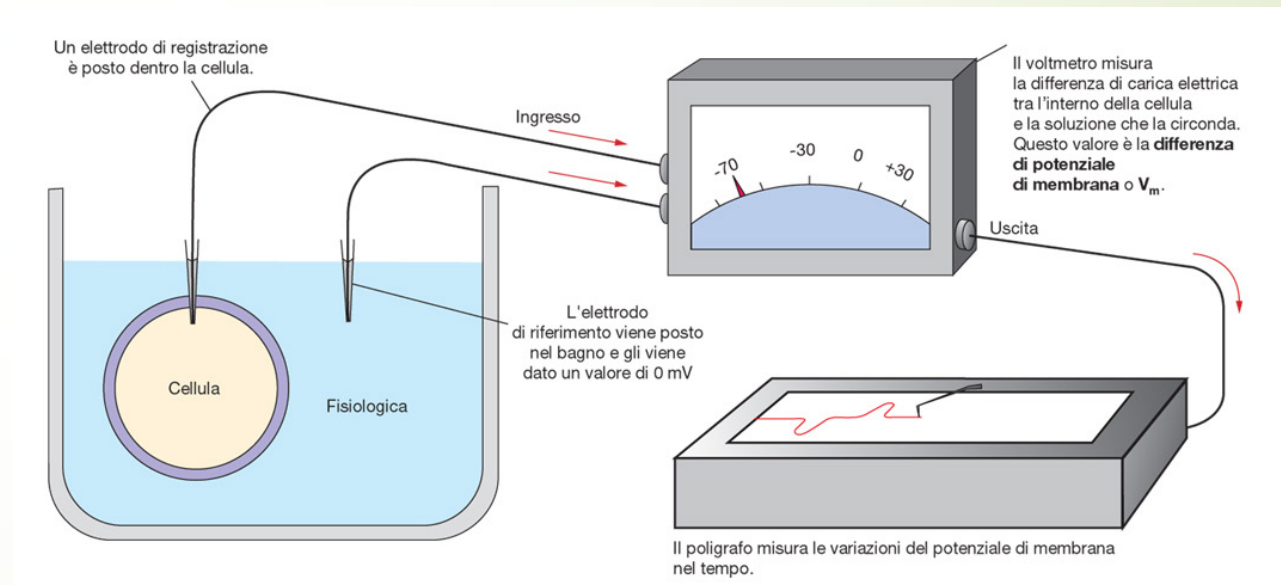

V_m is determined by a different concentration of **K⁺** and **Na⁺**. This different concentration together with the concentrations of other ions such as **Ca²⁺** and **Cl⁻**, give rise to the accumulation of positive charges at the outer face of the membrane and a negative charges accumulation on the inner face, with a difference of about -70mV

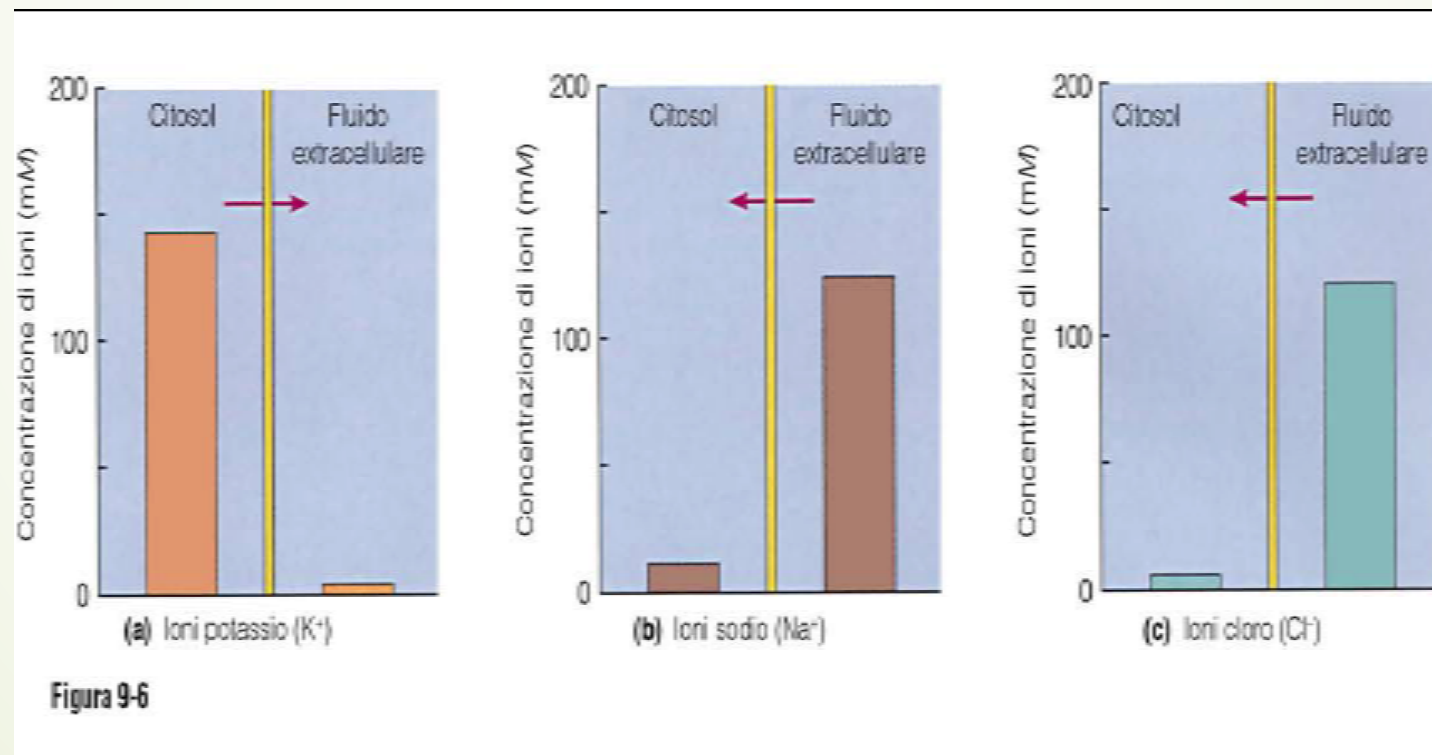

The ratio above the arrow indicate how much is concentrated the ion on one side as compared to the other

The arrow indicates the chemical gradient

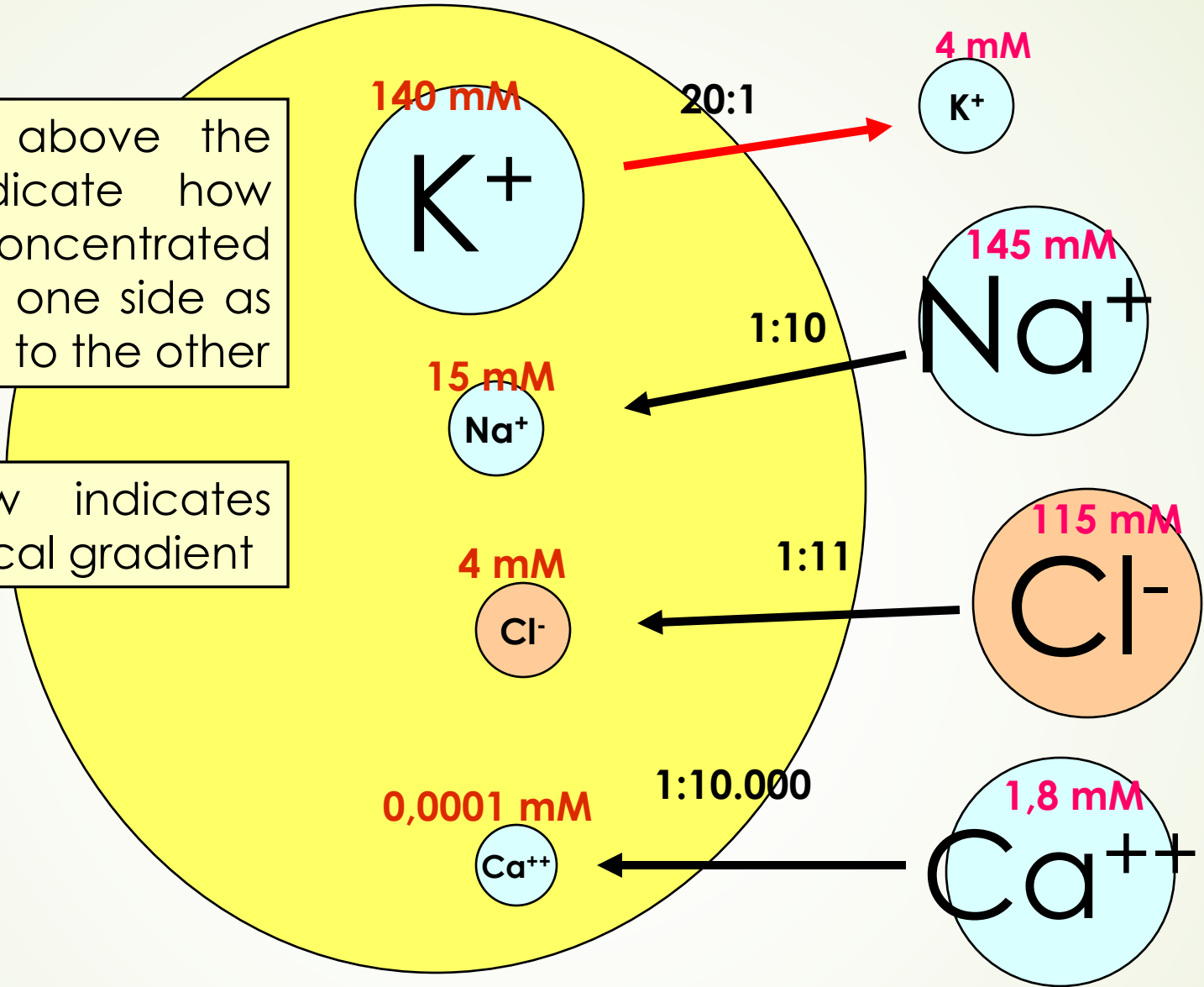

Why the V_m in resting conditions is around -70mV ?

Resting cells are permeable to **Na^+** and **K^+** . As an average the cells are about **40 times more permeable to K^+ than to Na^+** (more K^+ channels are open = leak channels) V_m is therefore closer to $V_{\text{eq}}\text{K}^+ = -90$ rather than $V_{\text{eq}}\text{Na}^+ = +60\text{mV}$. Small amount of Na^+ flow in the cells (leak channels) so that the V_m is less negative than if all Na^+ was not moving

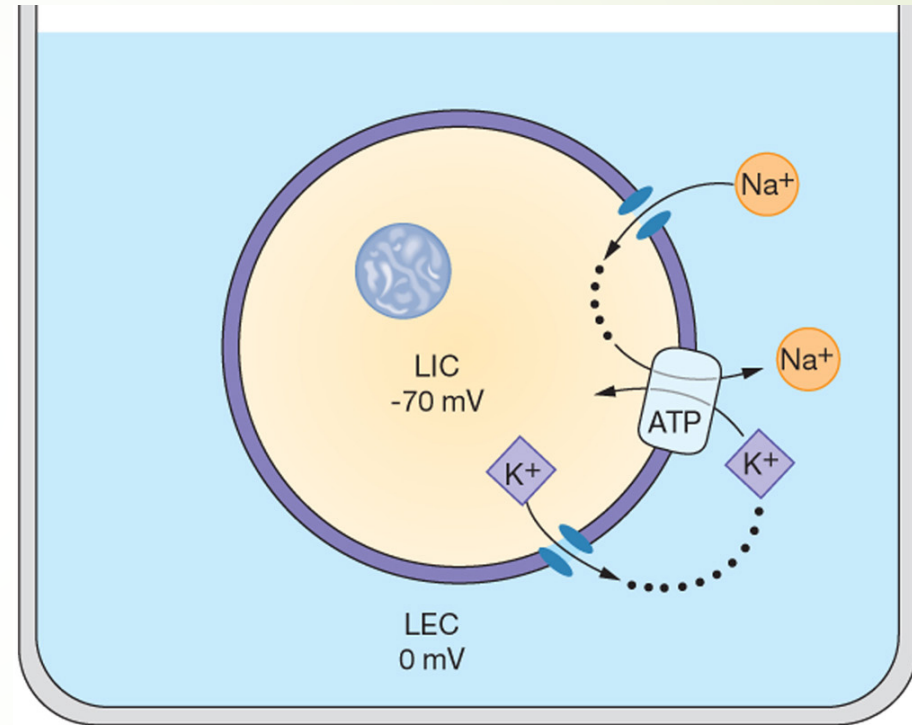

Na^+/K^+ ATPase maintains the gradients of Na^+ and K^+

NERNST
equation

$$V_{eq} = \frac{RT}{zF} \log \frac{C_{out}}{C_{in}}$$

Equilibrium potential (E) for important ions
in a neuron.

E_{Cl^-}	-70mV
E_{K^+}	-90mV
E_{Na^+}	+60mV
$E_{Ca^{2+}}$	+130mV

Electric representation of the cell membrane

A membrane behaves electrically like a

ohmic conductance

in parallel with a

capacitance

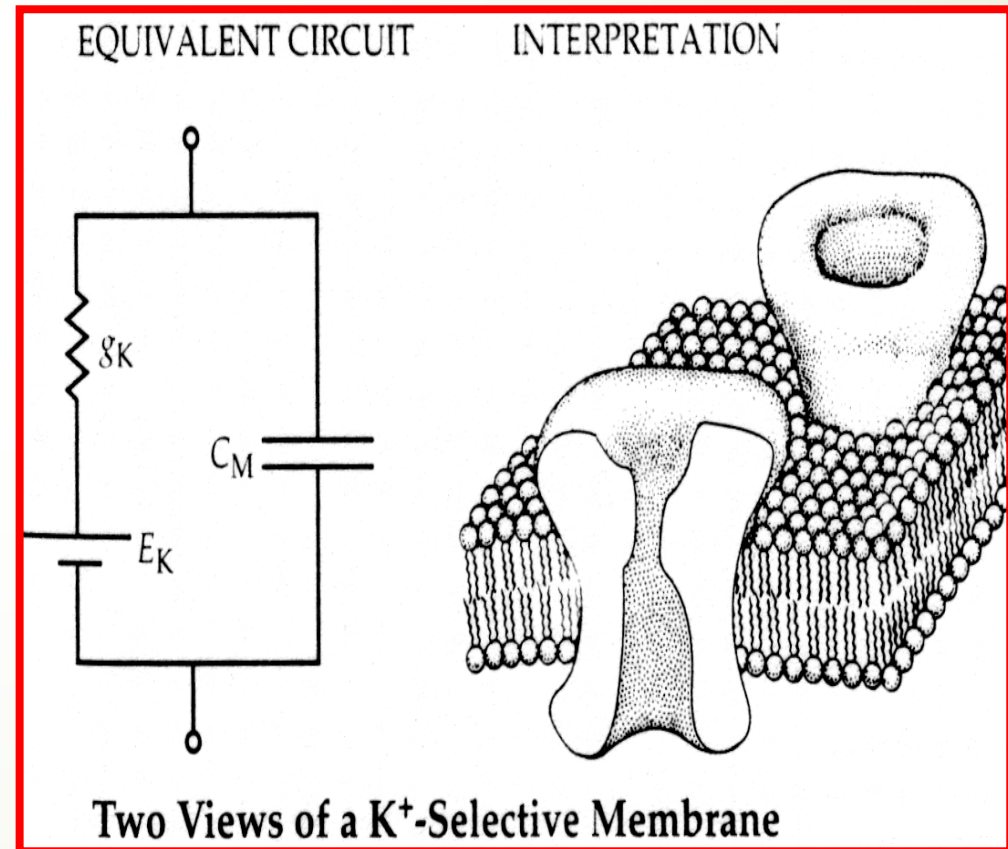

$$\Delta V = IR = I/G \text{ (units: volts)}$$

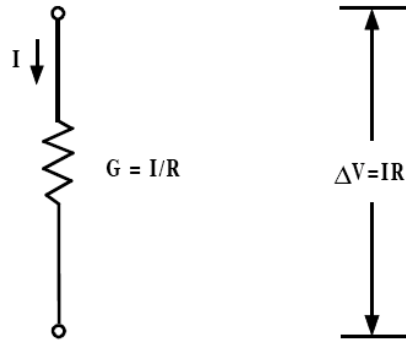

Ohm's Law

OHM's law

$$I = \frac{\Delta V}{R}$$

$R =$ resistance

$$G = \frac{1}{R} = \text{conductance}$$

$$I = \Delta V * G$$

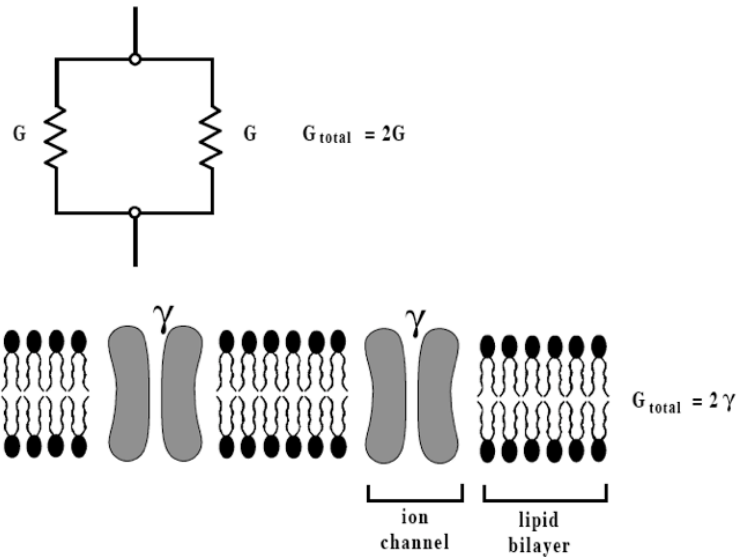

Figure 1-3. Summation of Conductance

Conductances in parallel summate together, whether they are resistors or channels.

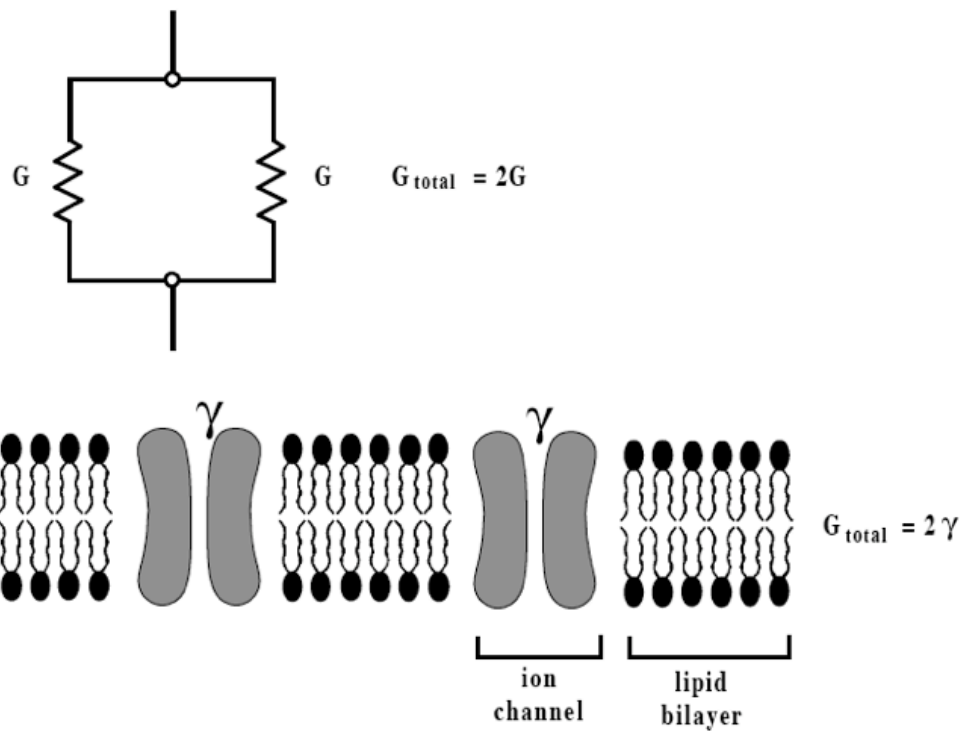

Figure 1-3. Summation of Conductance

Conductances in parallel summate together, whether they are resistors or channels.

Membrane capacitance

determines the ability to separate charges of opposite sign

$$C_m = \frac{\epsilon A}{d}$$

ϵ =dielectric constant

The charge stored in a capacitor is the product of capacitance and voltage

$$Q = C\Delta V$$

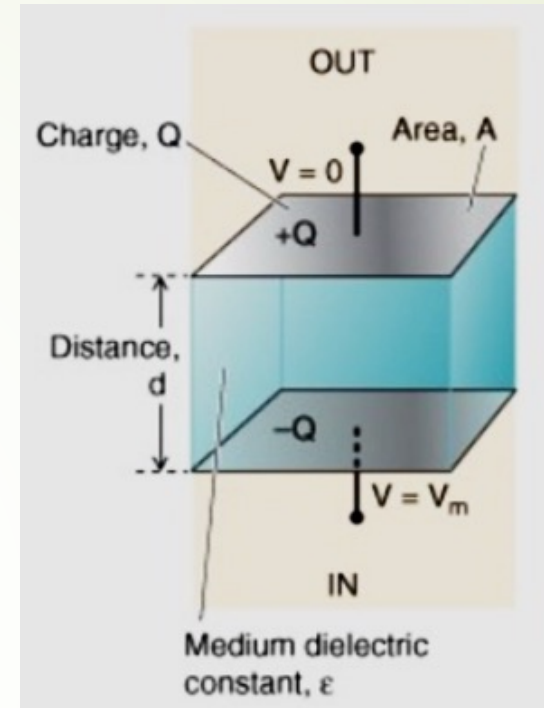

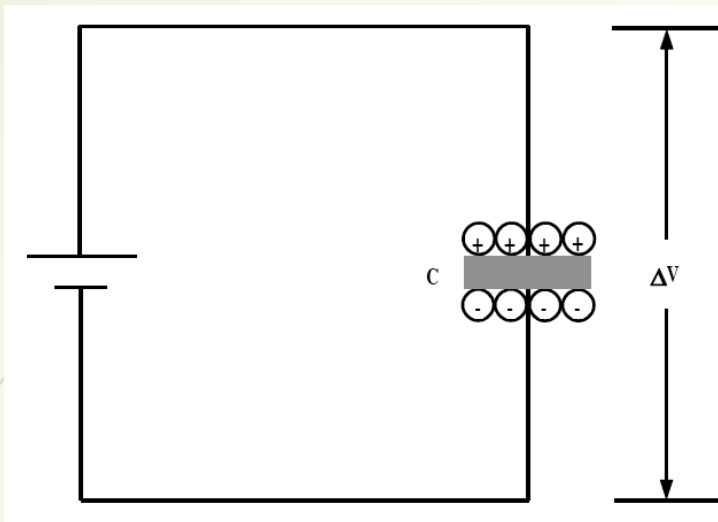

Phospholipid Bilayer

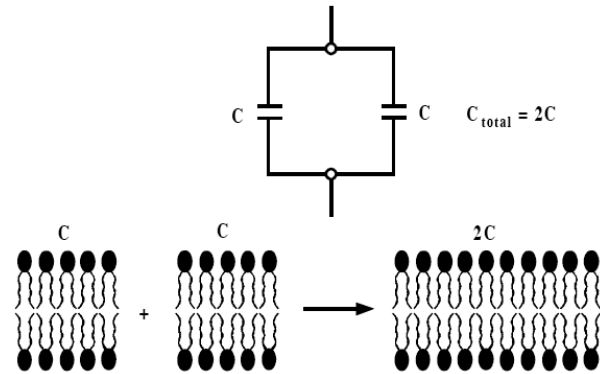
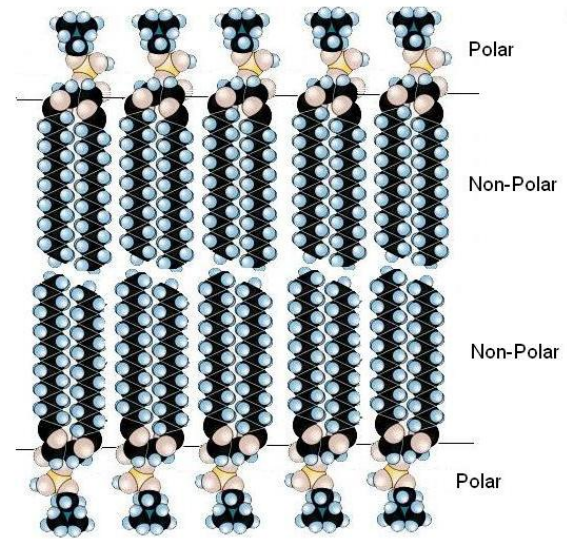

Figure 1-12. Capacitors in Parallel Add Their Values

When multiple capacitors are connected in parallel, this is electronically equivalent to a single large capacitor; that is, the total capacitance is the sum of their individual capacitance values (Figure 1-12). Thus, membrane capacitance increases with cell size. Membrane capacitance is usually expressed as value per unit area; nearly all lipid bilayer membranes of cells have a capacitance of $1 \mu\text{F}/\text{cm}^2$ ($0.01 \text{ pF}/\mu\text{m}^2$).

$$I_m = I_i + I_c$$

$$I_i = G(V_m - E_{ion})$$

$$I_c = \frac{\Delta Q}{t} = \frac{C_m \Delta V_m}{t}$$

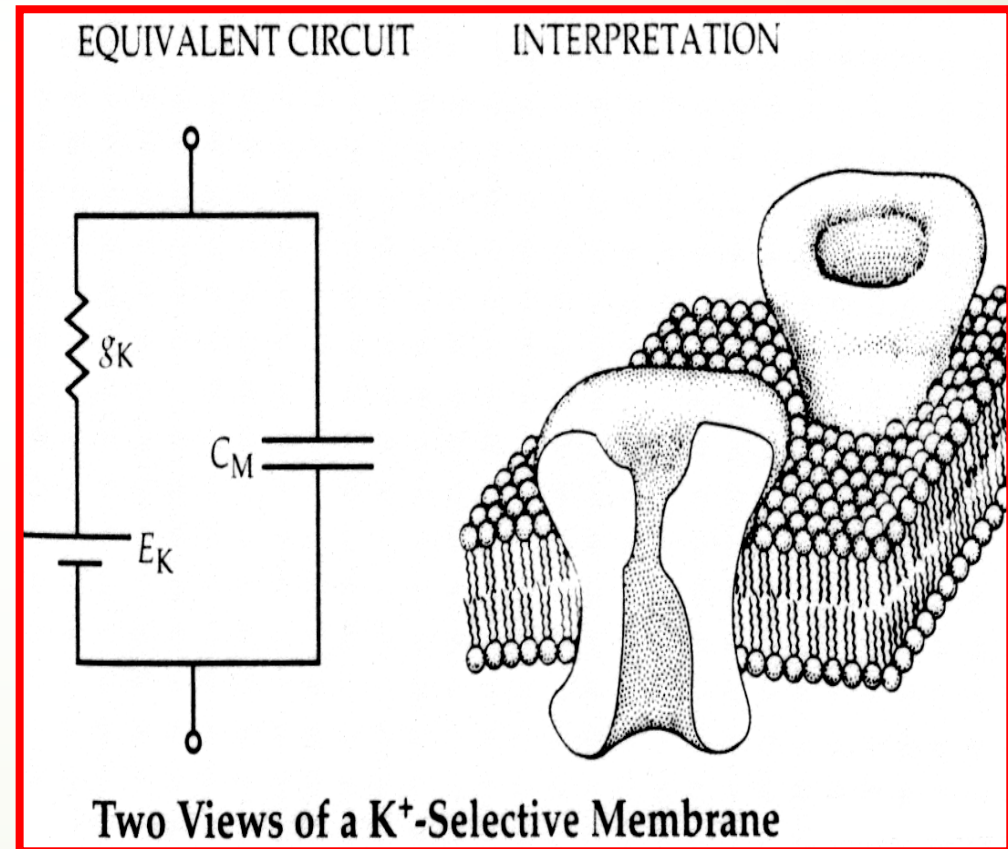

The variation of the membrane potential generates electrical signals due to the membrane potential variation in the time unit

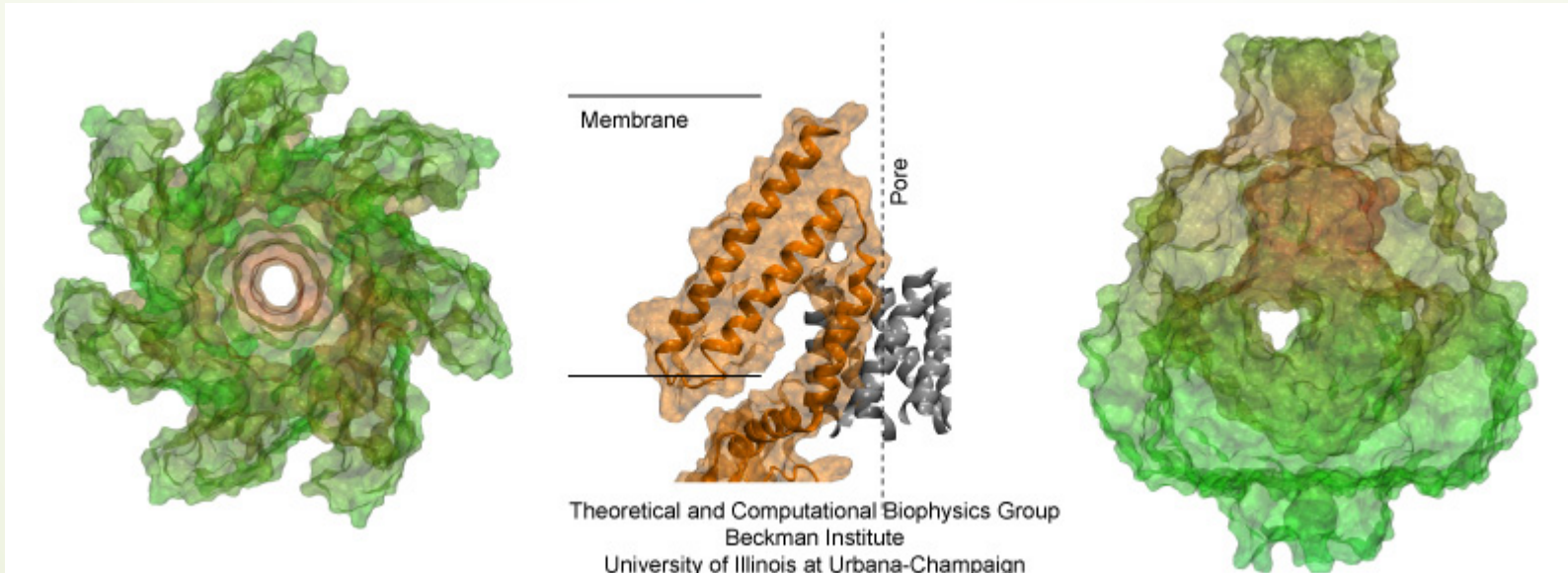
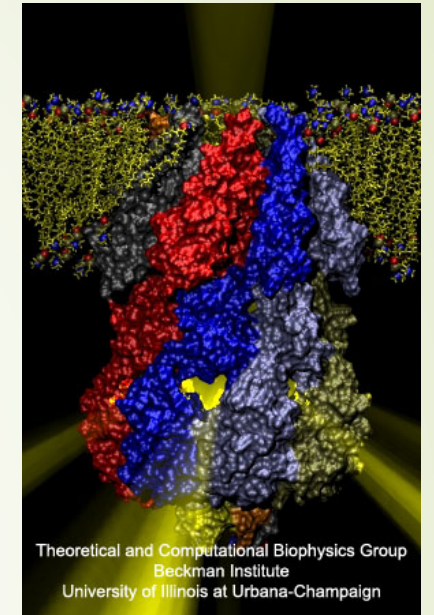
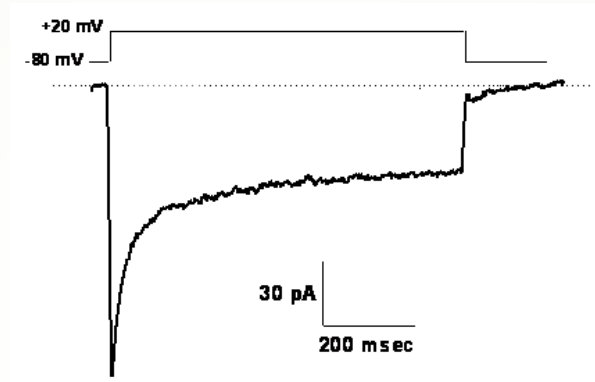
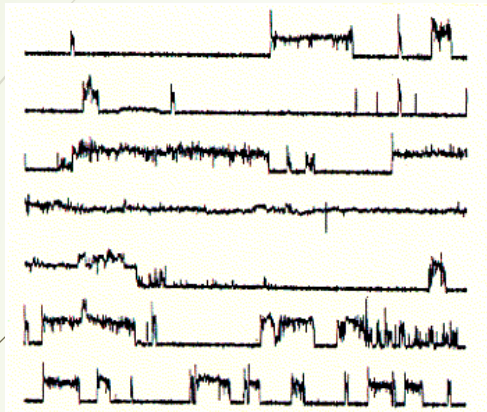

Fine '700 Galvani e Volta: elettricità animale ed artificiale

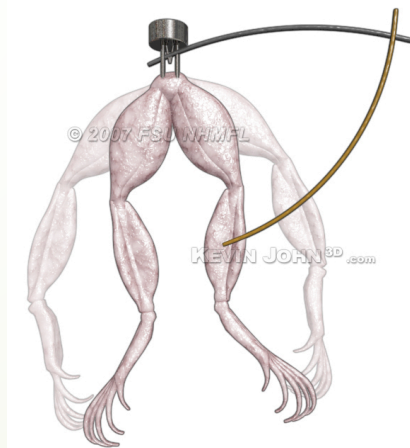
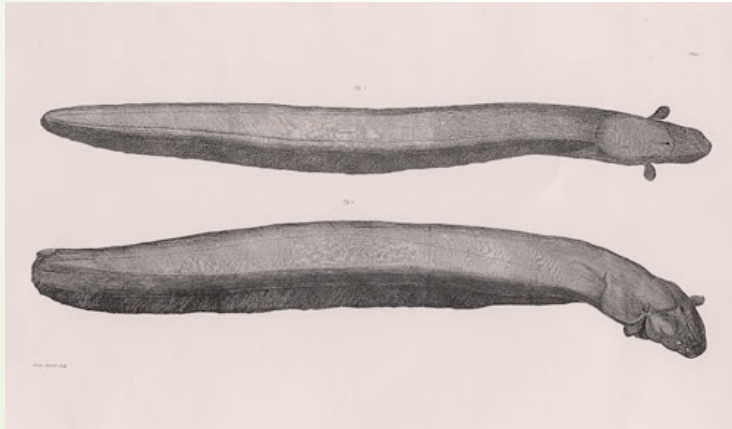
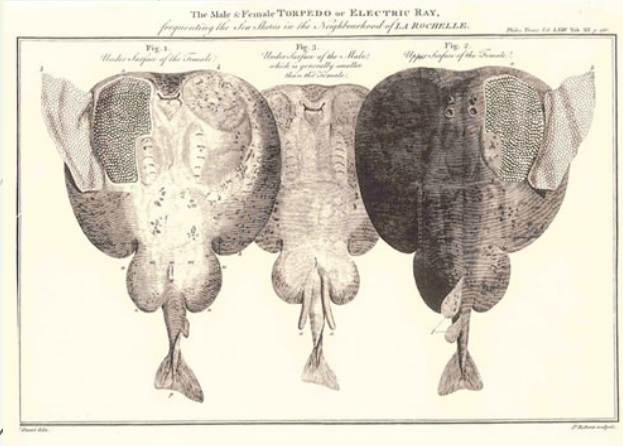

Measure of electrical signal from the entire body ...

E.E.G.: electroencephalograms
ECG, EMG

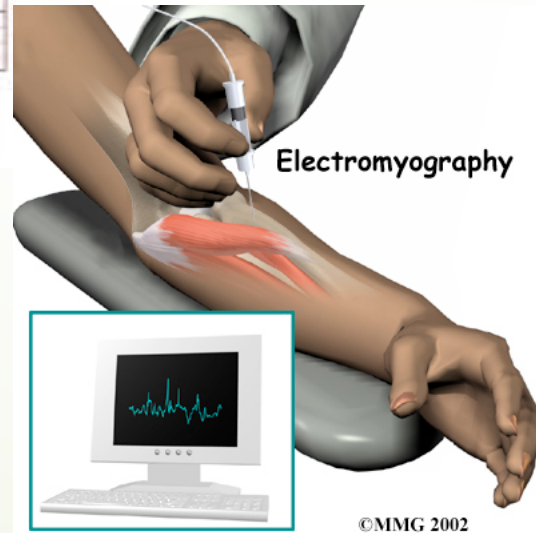
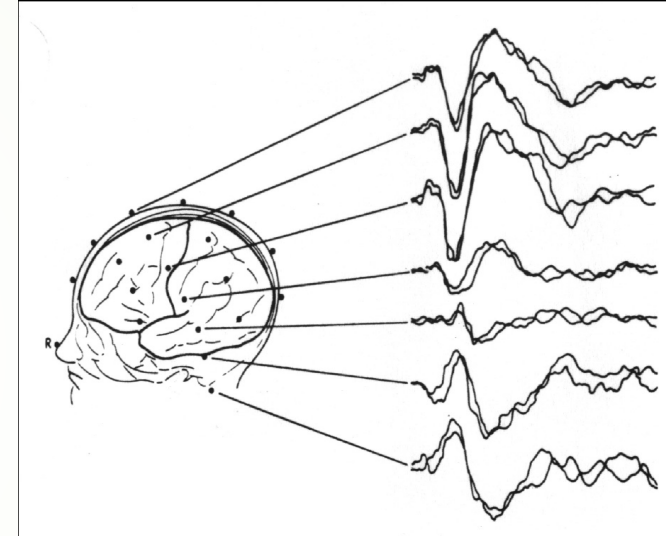
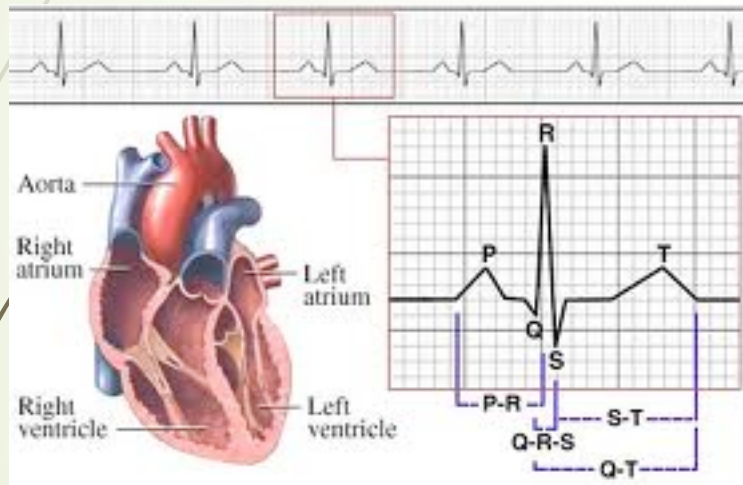

...to the cells in culture

Neurons in Culture

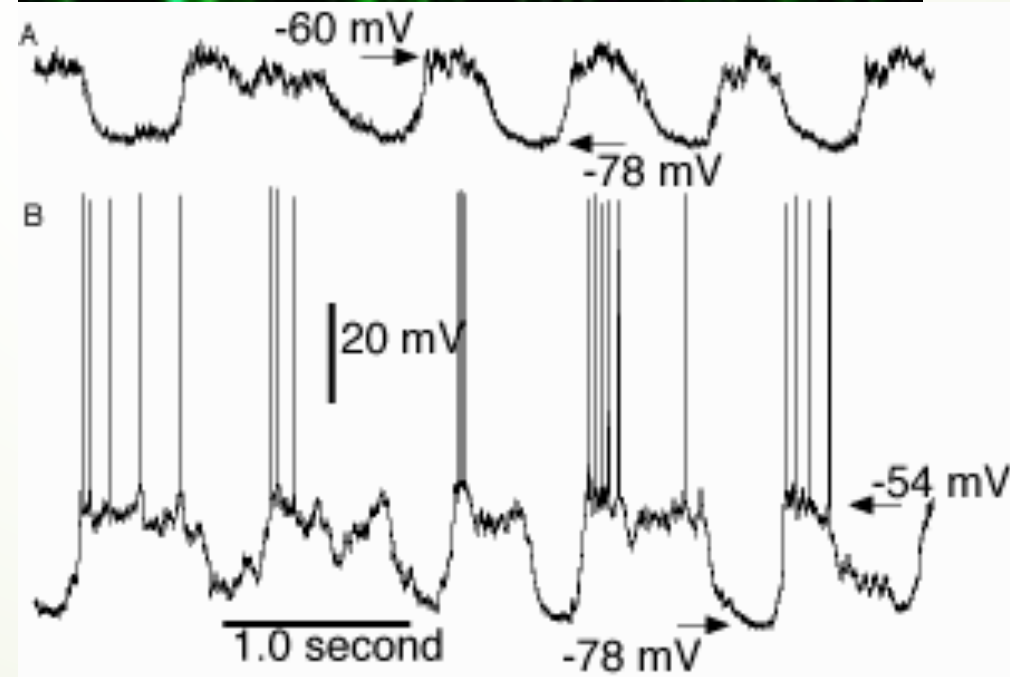
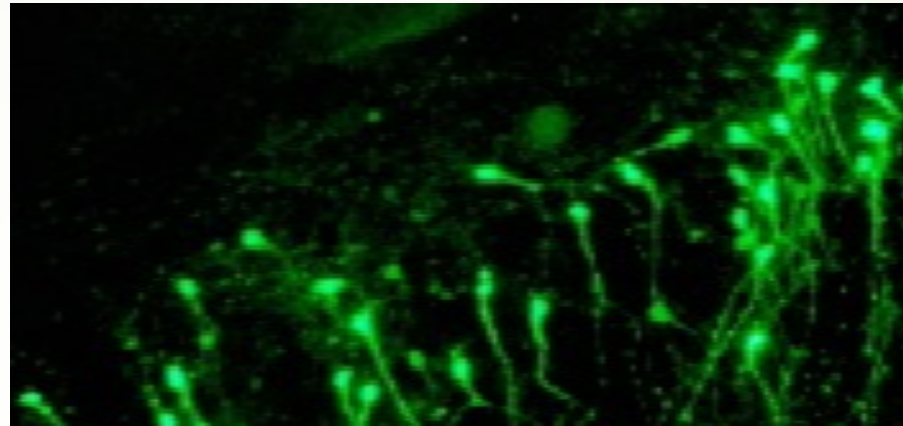

...to isolated cells

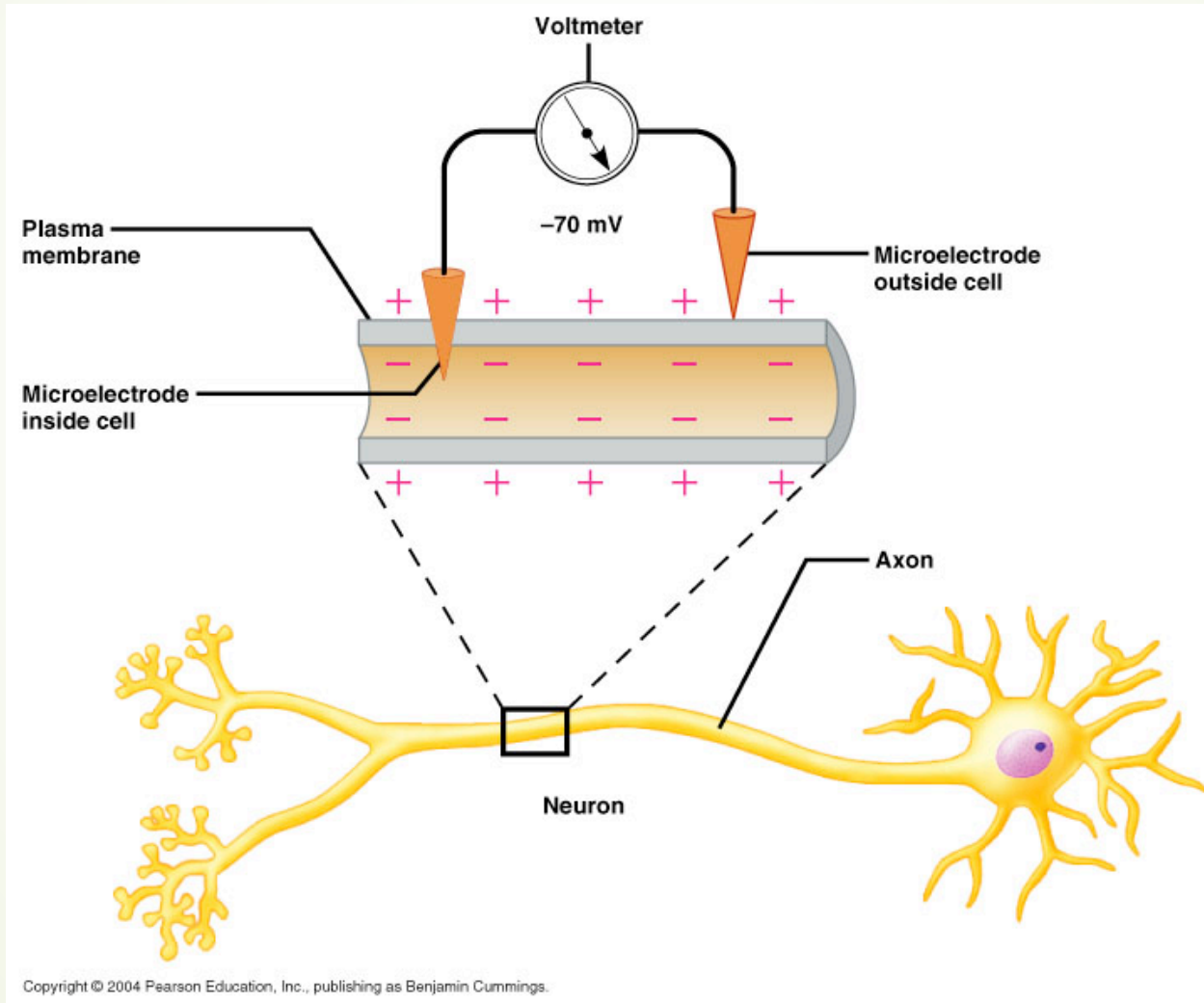

Electrotonic potential (EPSP; IPSP)

- graded
- local (propagation with exponential decay)
- integration
- depolarization/hyperpolarization

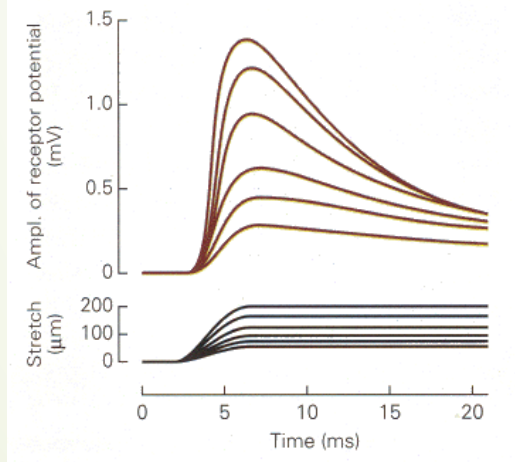

Action potential

- all or none
- long distance propagation
- always a depolarization

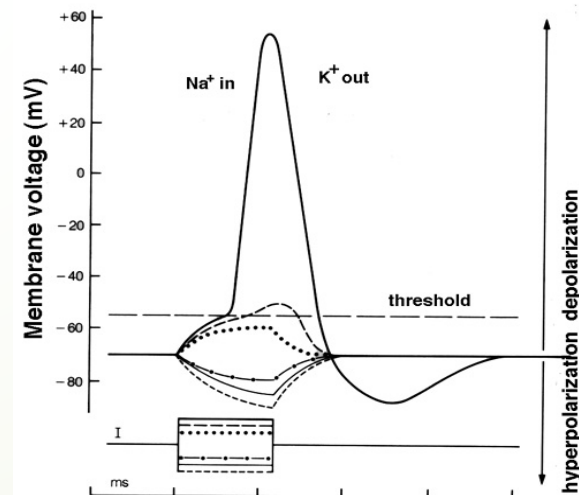



Functions

Electro tonic potential

- **Sensorial systems: receptor potential**
- **Chemical synapses: postsynaptic potential**
- **Amplitude codification**

Action Potential

- **Muscle contraction**
- **Long distance communication**
 - **Secretion (Exocytosis)**
 - **Frequency codification**

EPSP Vs ACTION POTENTIAL:

Property	EPSP or IPSP or Graded potential	Action Potential
Magnitude	Low	High
Propagation & Duration	Nil; it remains localized (up to 20 msec)	Self propagating (up to 2 msec)
Refractory period	absent	present
All or none law	Not obeyed. It is graded.	obeyed
Summation	Present	absent
Decrement (decline of size with distance)	present	Absent. Size is constant
Increased permeability to ions	To Na ⁺ & K ⁺ at one time but Na ⁺ influx >	Na ⁺ Influx , then K ⁺ efflux

Cellular Excitability

Require: high expression of Voltage-gated channels



Ability to generate Action Potential
If stimulated

Excitable cells:

Neurons

Muscle (striated and smooth)

Secreting cells

Some cells are **auto excitable**: they don't need external stimuli to promote Action Potential (pacemaker cells in the heart, neurons)

Action Potential phases

Hodgkin and Huxley (1939):
Classical studies on giant Squid Axon intracellular measurements

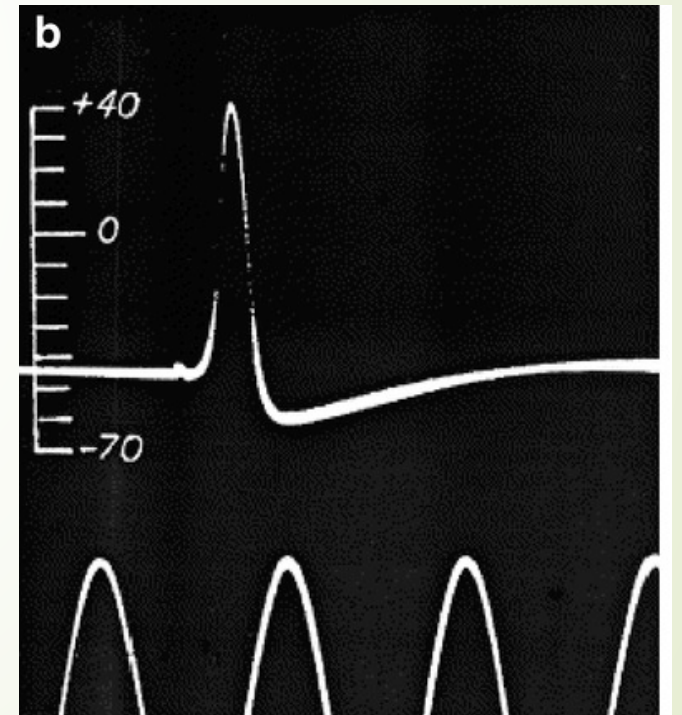
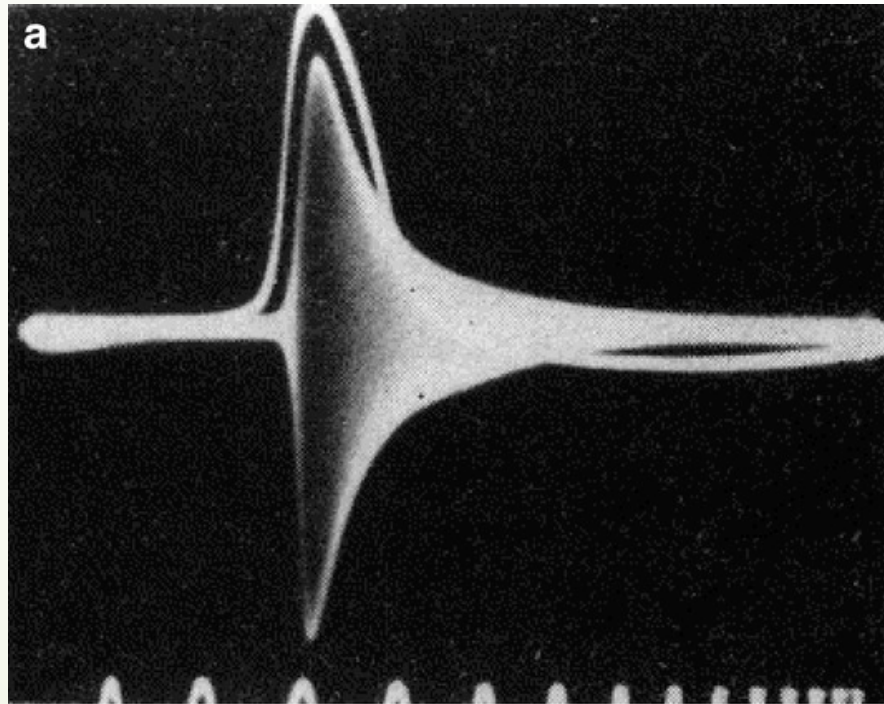

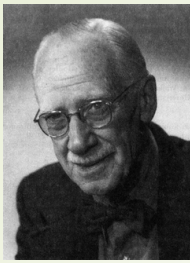

Cole ('47)

VOLTAGE CLAMP technique

Quantitative analysis of ionic currents 'blocking' membrane voltage at a given value.

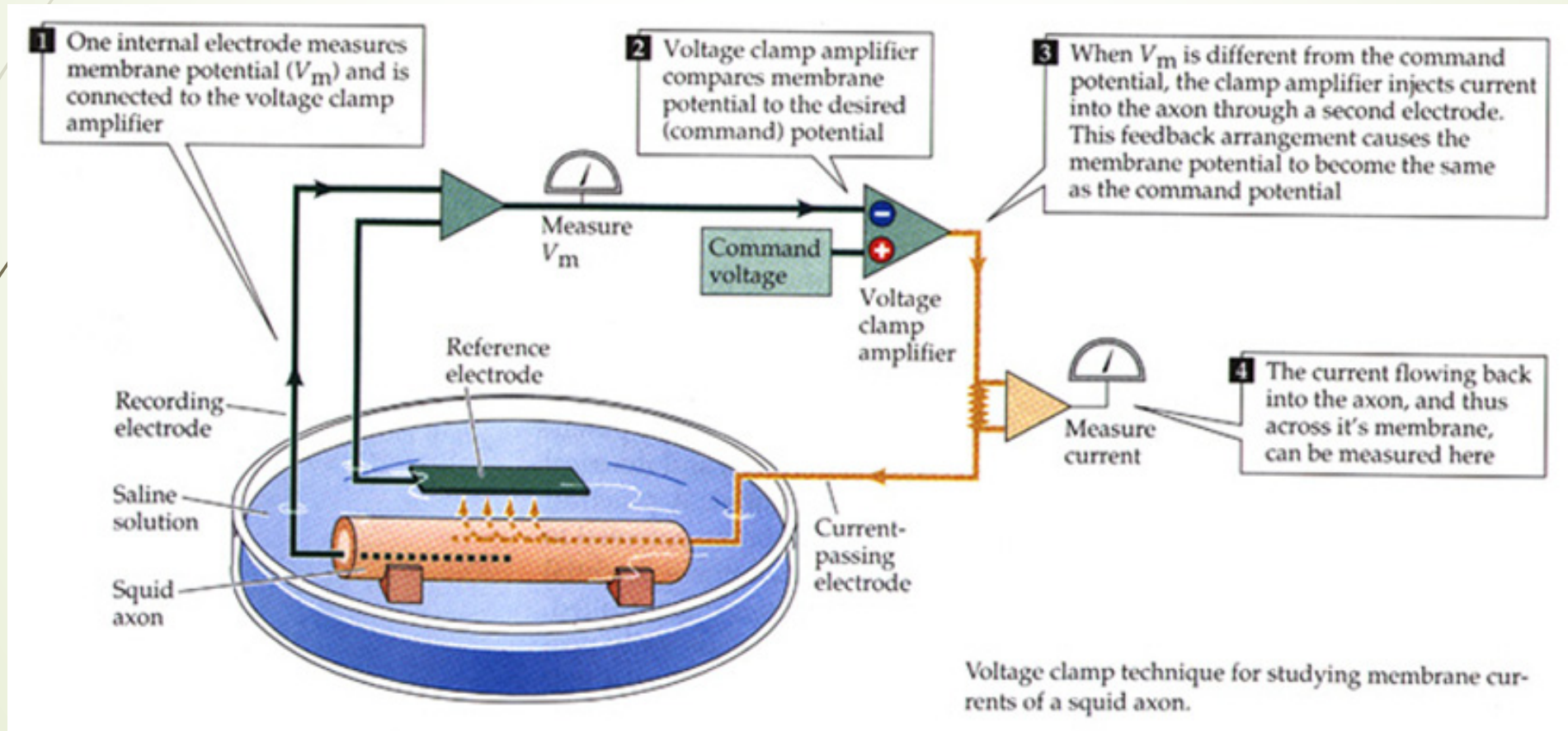

Action Potential phases

Hyperpolarizing stimuli:
The responses are similar to a RC circuit.

Depolarization with sufficient intensity:

Action Potential = fast membrane changes to 0 and over (OVERSHOOTING) reaching about +40mV.

Fast repolarization phase under the resting initial potential (UNDERSHOOT)

TOT DURATION in giant squid axon = few milliseconds

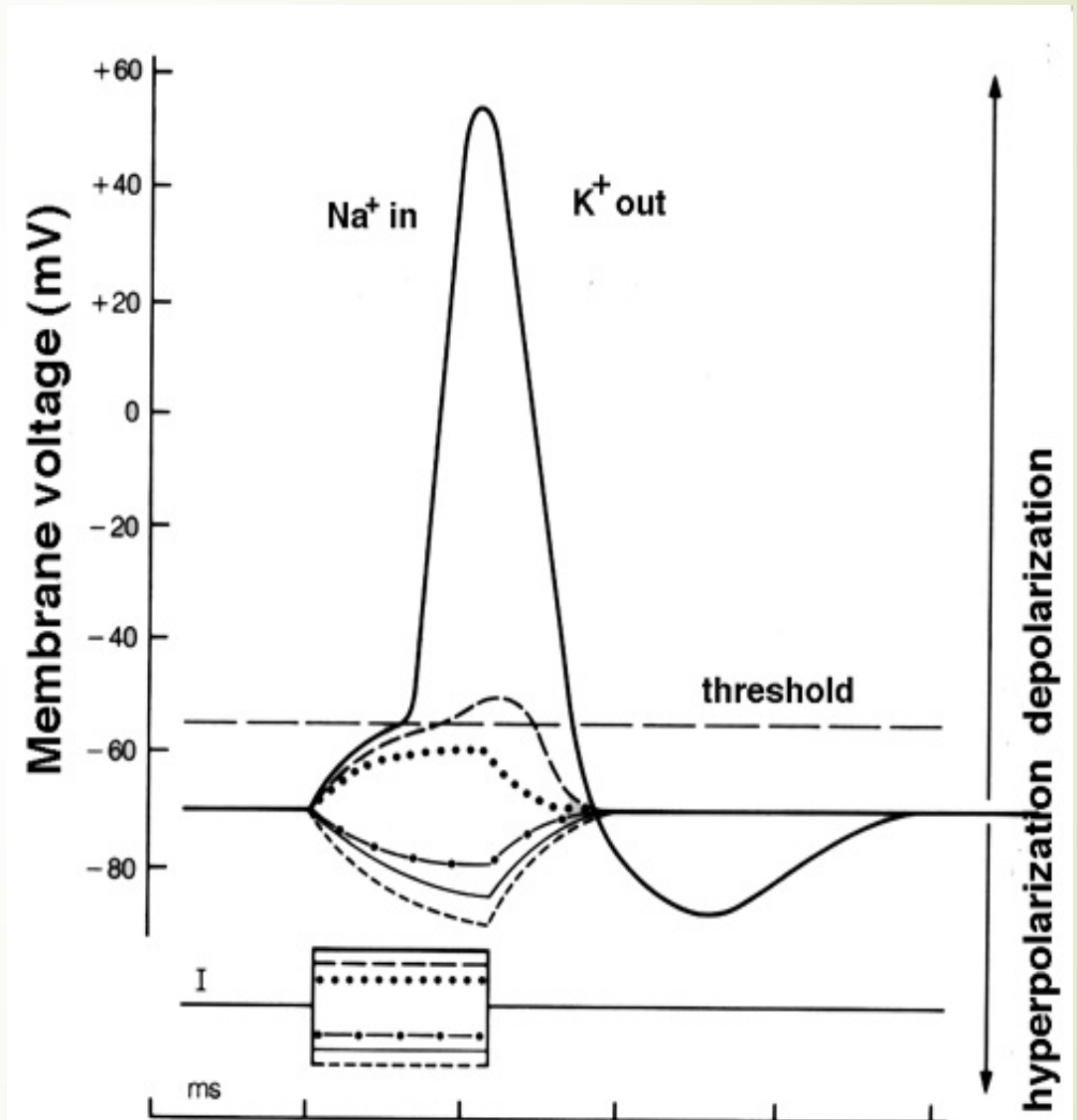

Action Potential phases

Action Potential is evoked when the V_m reaches a THRESHOLD value. This value is not a constant but can be changed by changing the stimulating conditions

If the stimuli changes linearly rather than in steps, we can observe an increase in the threshold: **ACCOMODATION** due to the inactivation of Na^+_v

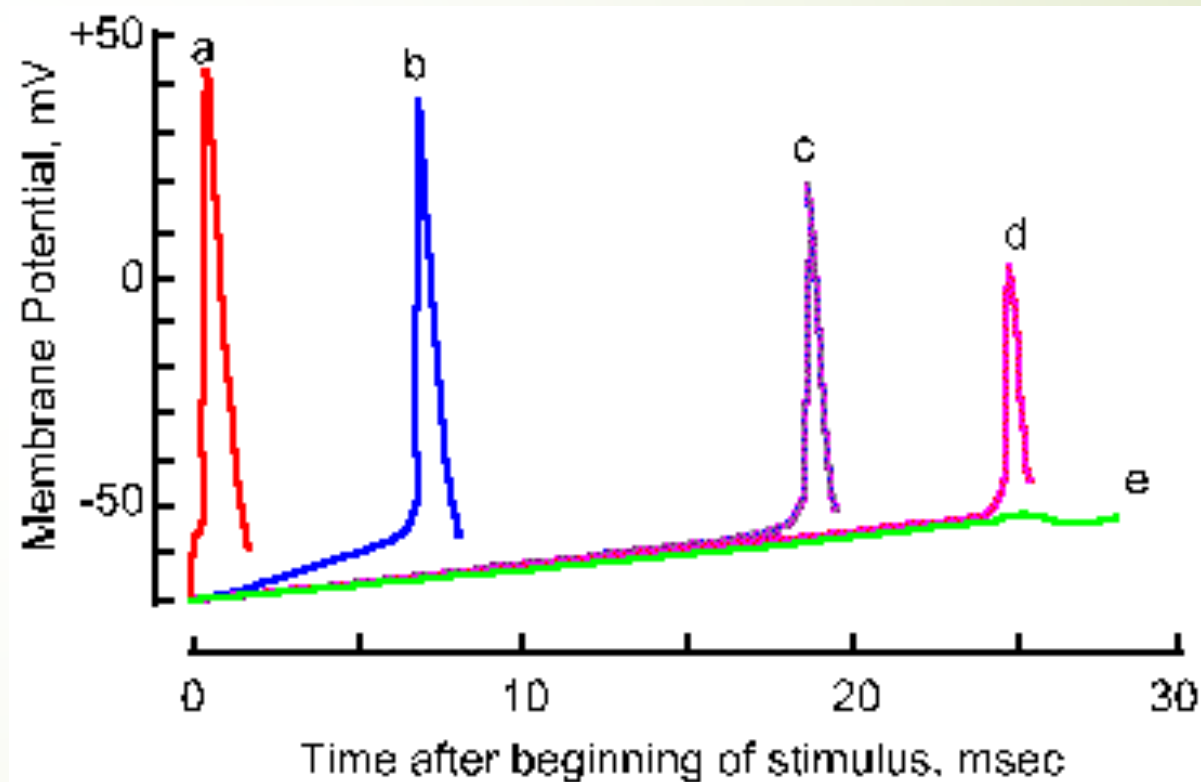

Action Potential phases

Na^+_v inactivation is also responsible for the **REFRACTORY PERIOD**. Beside the fast processes regulating the action potential in ms, there is a slower process without visible effect on the potential but necessary to recover the axon to the initial excitability conditions

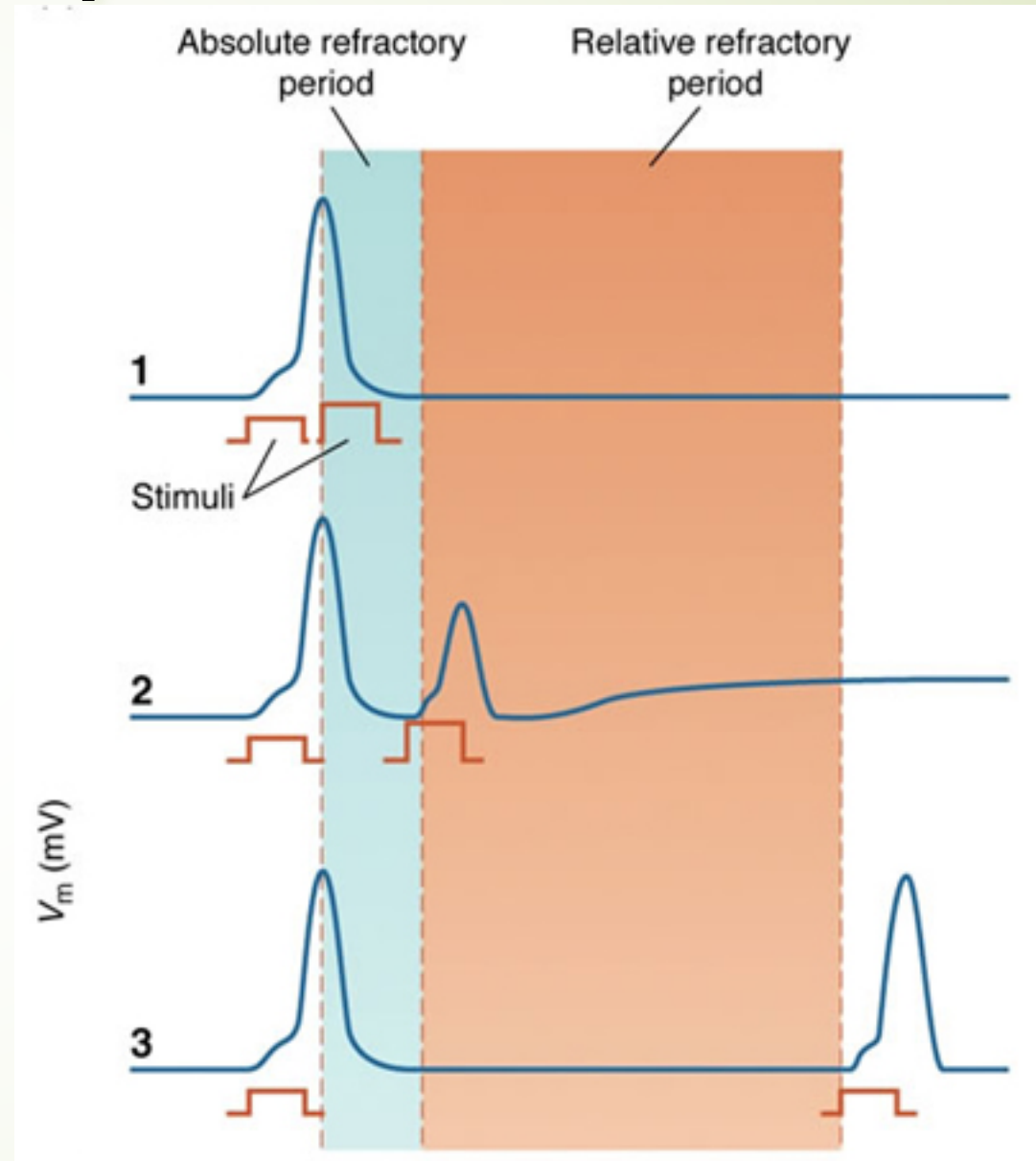

The Sodium hypothesis

Hodgkin and Katz described in 1949 the Dependency of the **OVERSHOOT** from Na^+

The effect of **reducing the external sodium** concentration on the action potential in a squid giant axon. In each set of records, record 1 shows the response with the axon in sea water, record 2 in the experimental solution, and record 3 in sea water again. The solutions were prepared by mixing sea water and an isotonic dextrose solution, the proportions of sea water being a, 33%; b, 50%; c, 71%. From Hodgkin and Katz (1949).

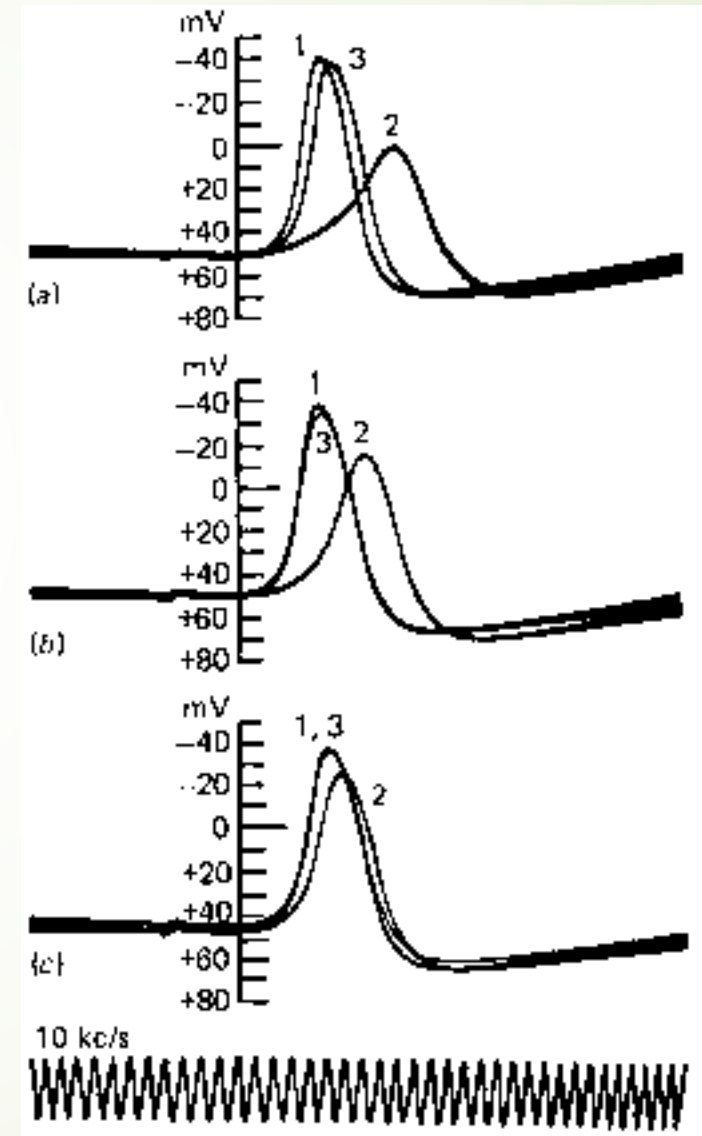

The Sodium hypothesis

From these experiments emerged the idea that the membrane becomes more permeable to Na^+ as compared to K^+ and therefore V_m tends to V_{Na^+} . The peak of the action potential in fact always close to V_{Na^+} ($=+40$)

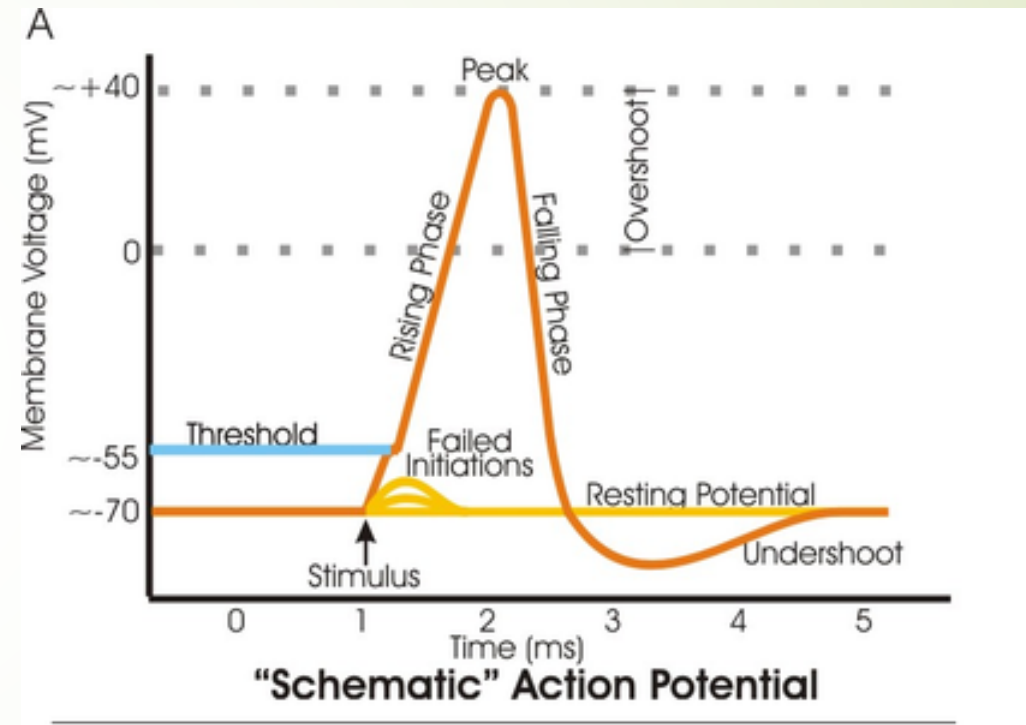



Hodgkin



Huxley

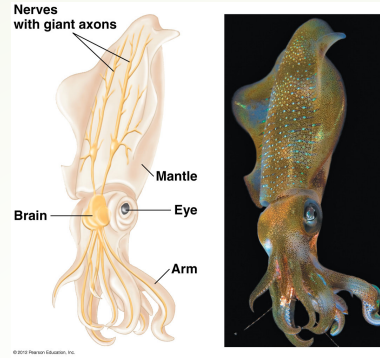

1952: they proposed the existence of voltage-dependent channels !!

(the structure of biological membranes was still unknown...)

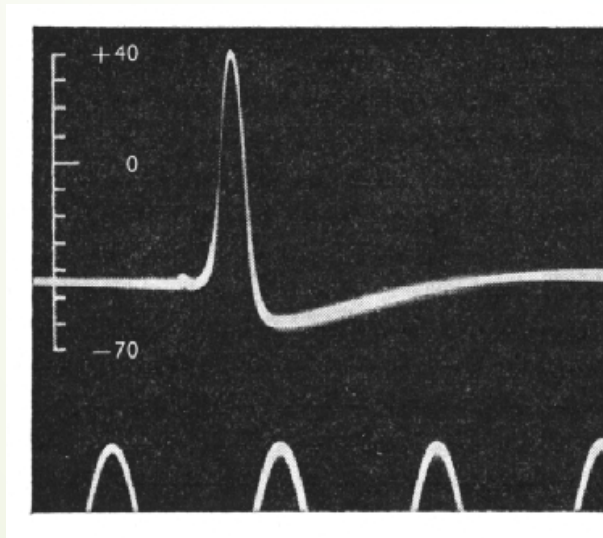

Action potential

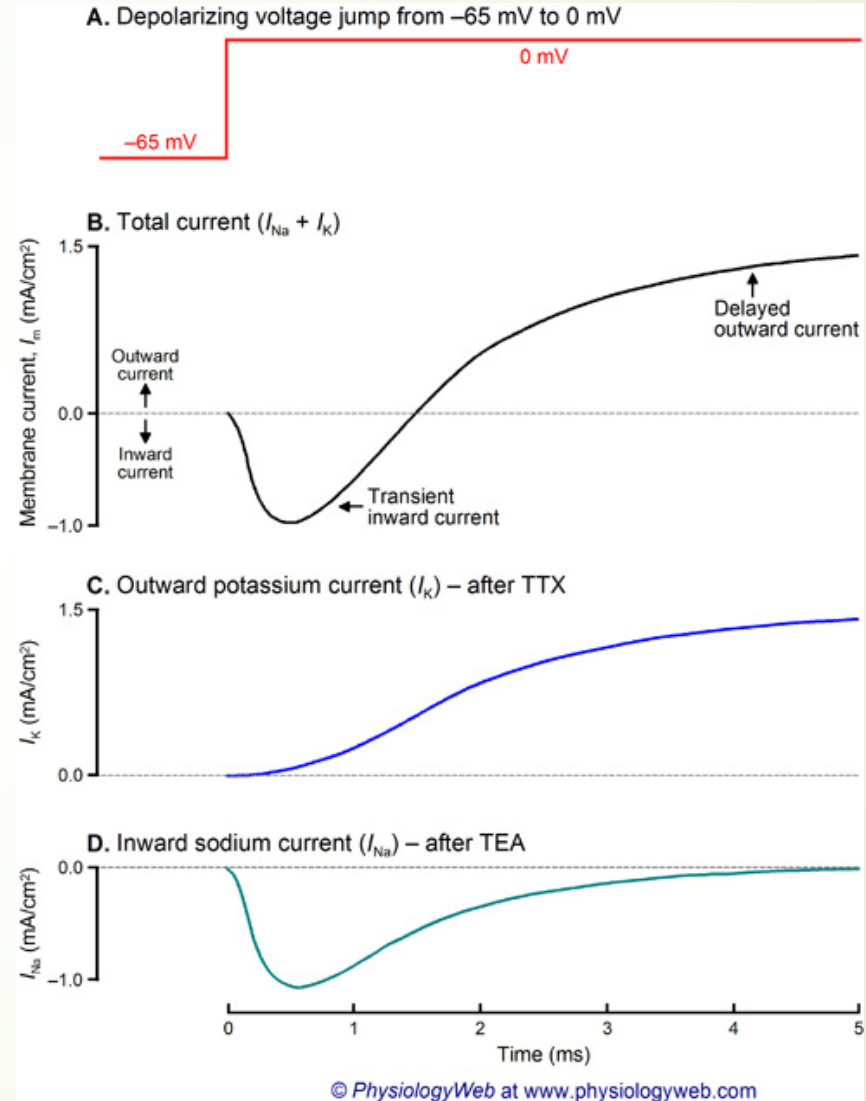

Na⁺ and K⁺ currents (I) calculated at different V

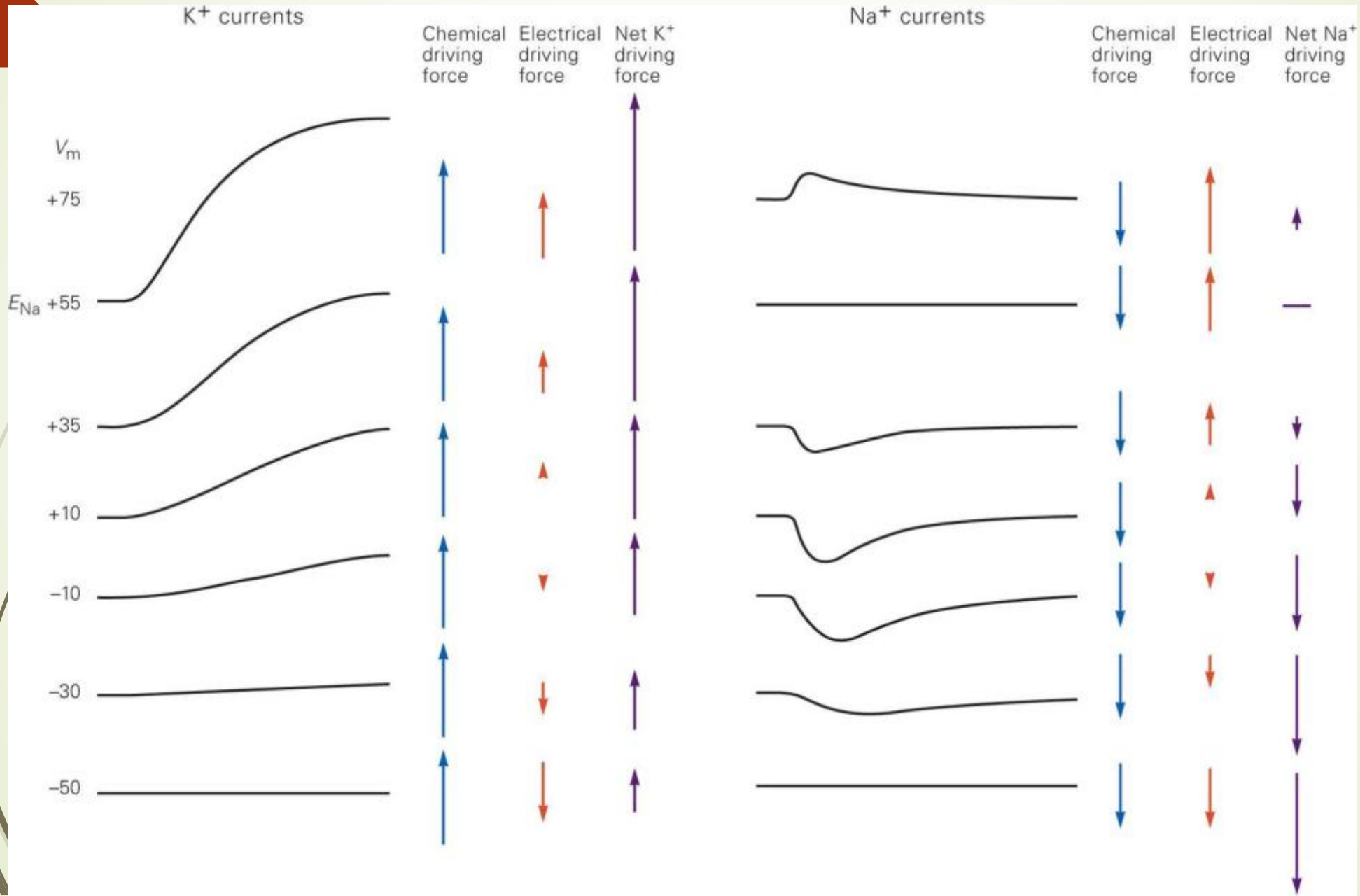

Na⁺ and K⁺ conductances (g) are calculated from their currents

From the I values obtained Hodgkin and Huxley were able to obtain g_{Na} and g_K by the following equation

$$g_{Na} = \frac{I_{Na}}{V - V_{Na}}$$

$$g_K = \frac{I_K}{V - V_K}$$

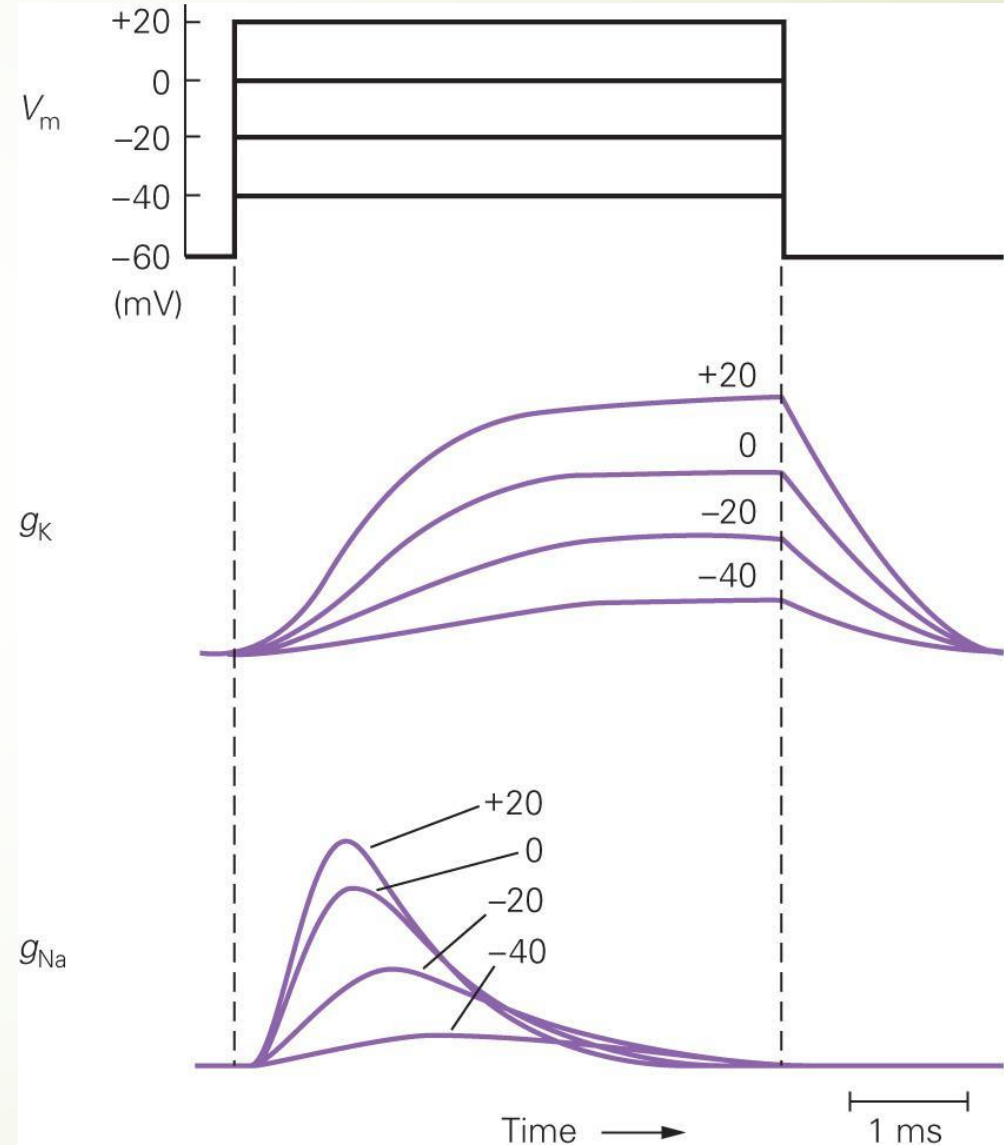

Na⁺ and K⁺ conductances (g) are calculated from their currents

Two **common features**:

- Both g increase in response to depolarization
- As the size of depolarization increases, the g increases

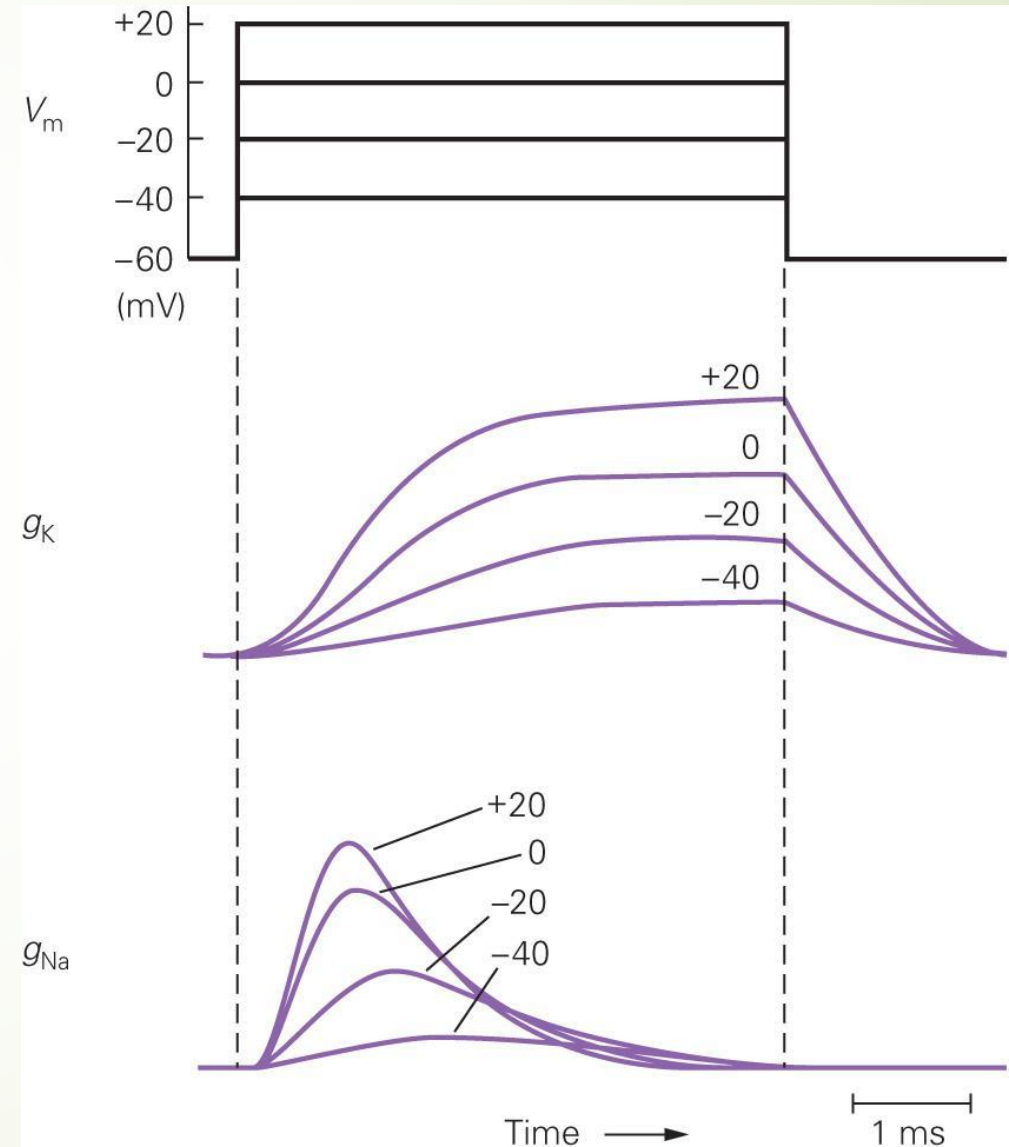

Na⁺ and K⁺ conductances (g) are calculated from their currents

Differences:

- The g differs in the rate at which they open:
g_{Na} is developing more rapid at every V_m as compared to g_K
- When depolarization is maintained for some times g_{Na} decrease leading to a decrease of inward current = INACTIVATION Na⁺ channels
- g_K (of the squid axon) remains stable as long as the membrane is depolarized (at least for depolarizations lasting 10ms)

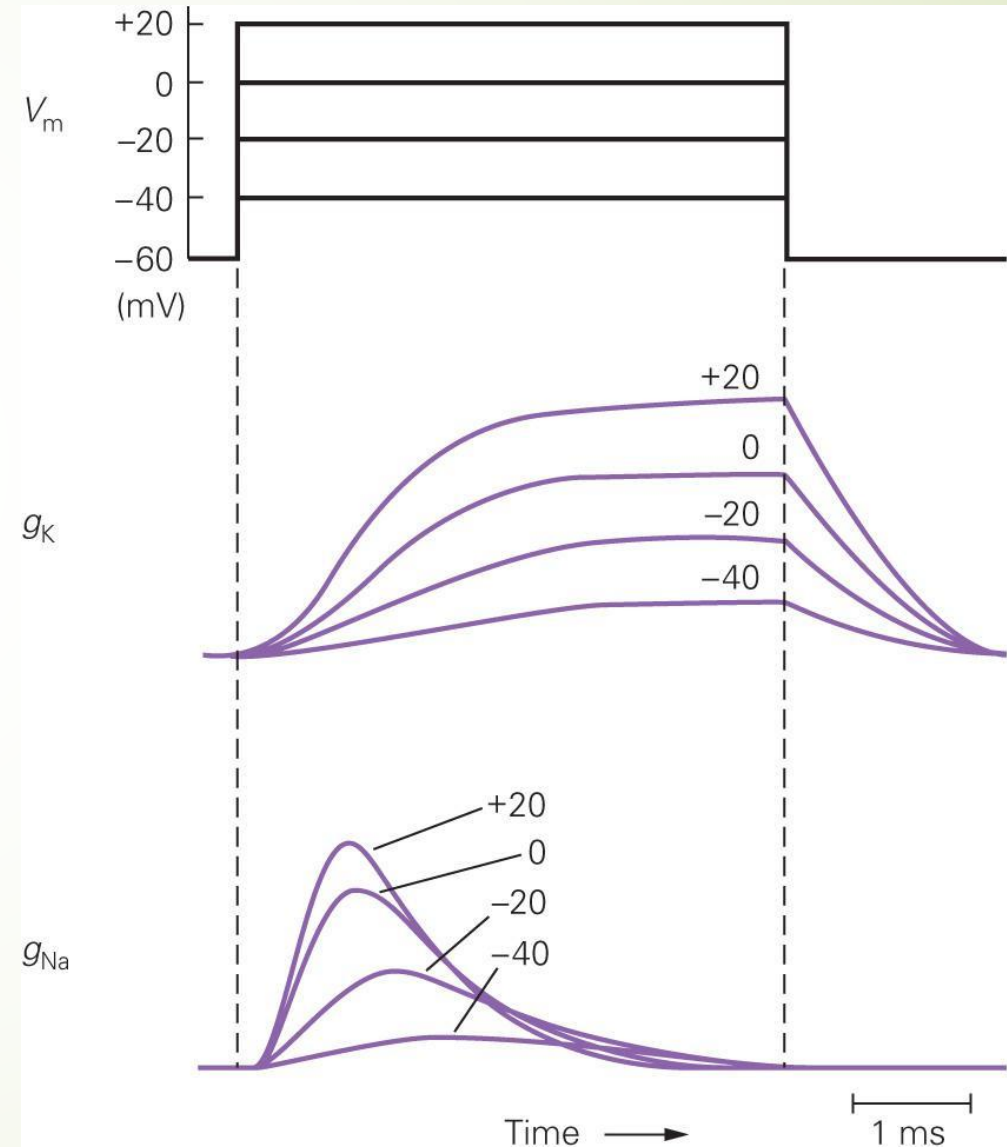

Na⁺ and K⁺ conductances (g) are calculated from their currents

Time-dependent effect of depolarization on g_{Na} are determined by the kinetics of two gating mechanisms in Na⁺ channels.

- Activation gate closed while the membrane is at resting potential and opened by depolarization.
- Inactivation gate open at resting potential and closes after the channel opens in response to depolarization. The channel conducts Na⁺ only when both gates are open.

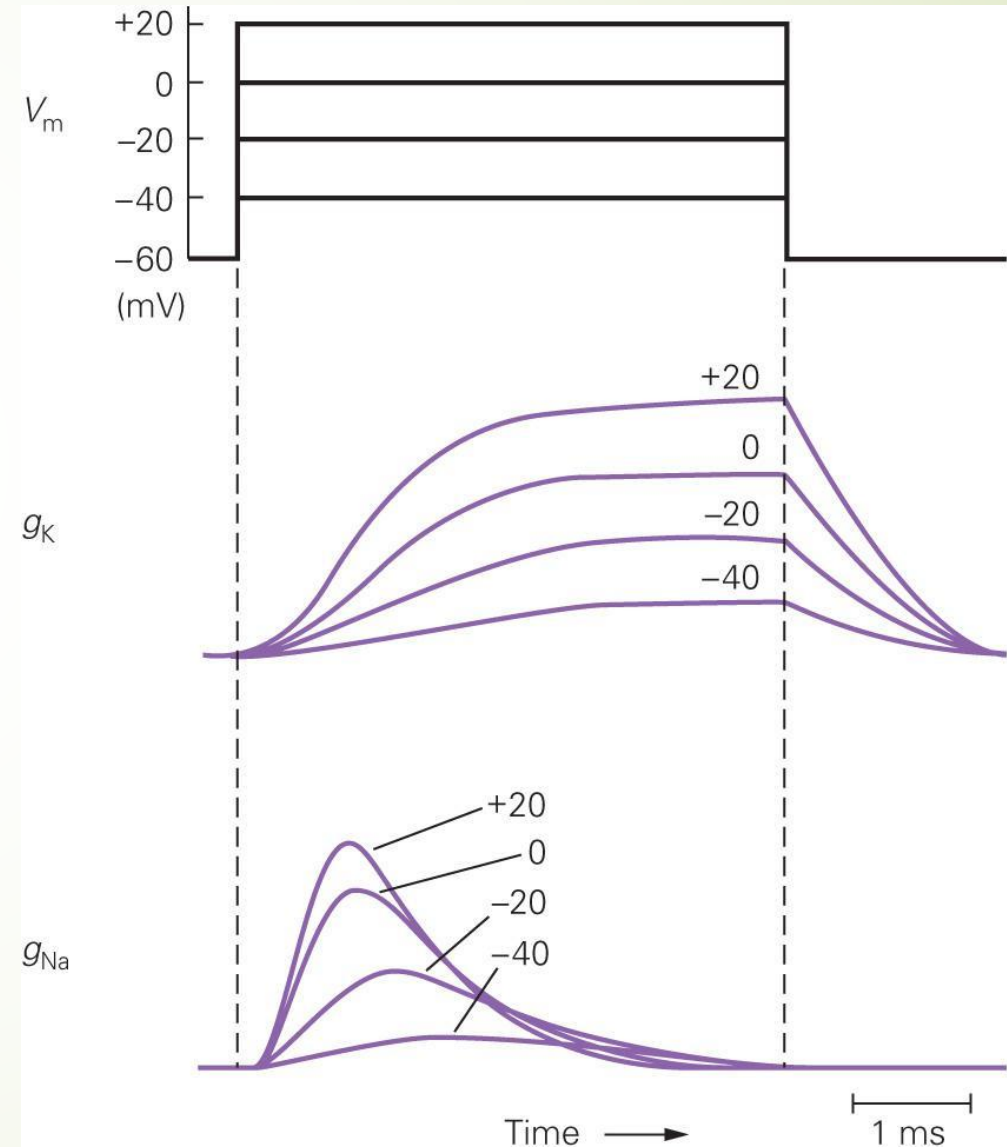

Action potential can be reconstructed from the properties of Na⁺ and K⁺ channels

Hodgkin and Huxley were able to fit their measurements of membrane g to a set of empirical equations that completely describe Na⁺ and K⁺ conductances as a function of membrane potential and time.

Using these equations and measured values for the passive properties of the axon, they computed the shape and conduction velocity of the action potential.

The calculated waveform of action potential matched the waveform of unclamped action potential almost perfectly indicating that the model developed by Hodgkin and Huxley accurately described the properties of the channels that are essential for generating and propagating the the Action potential. **This is still the most SUCCESSFUL QUANTITATIVE MODEL IN NEURAL SCIENCES (at least) if not in all biology**

Action potential can be reconstructed from the properties of Na^+ and K^+ channels

The model describe action potential as a process involving several steps

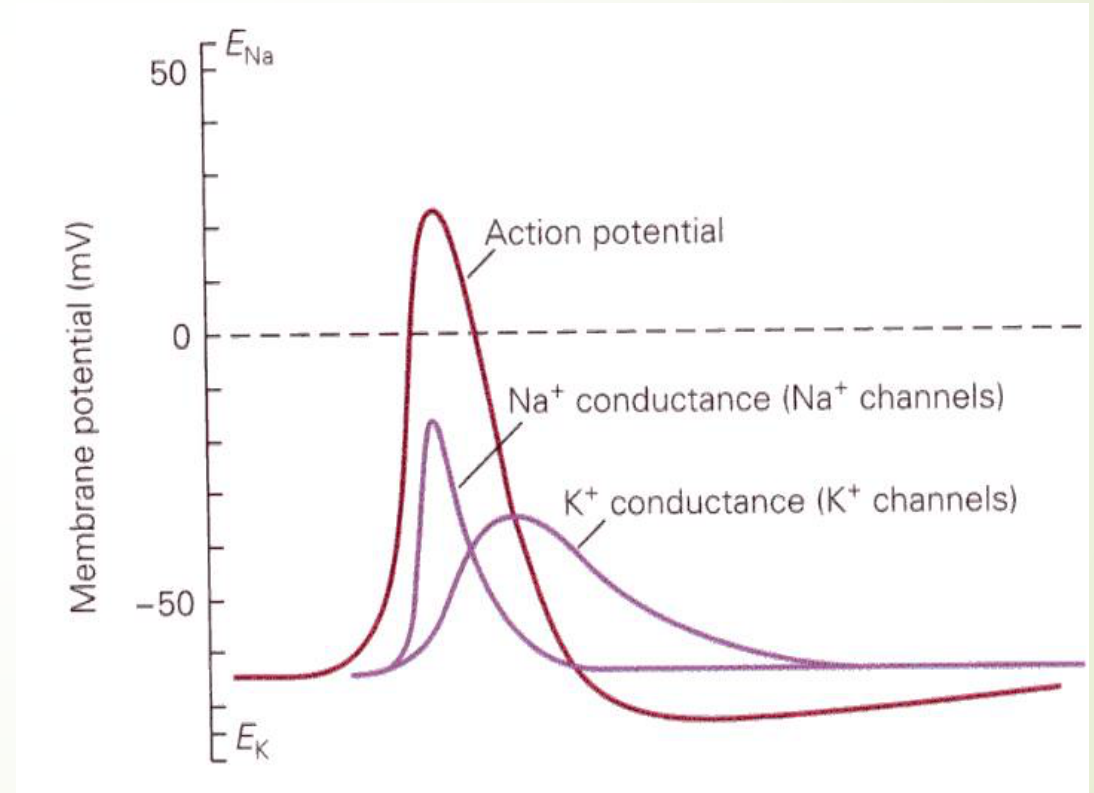
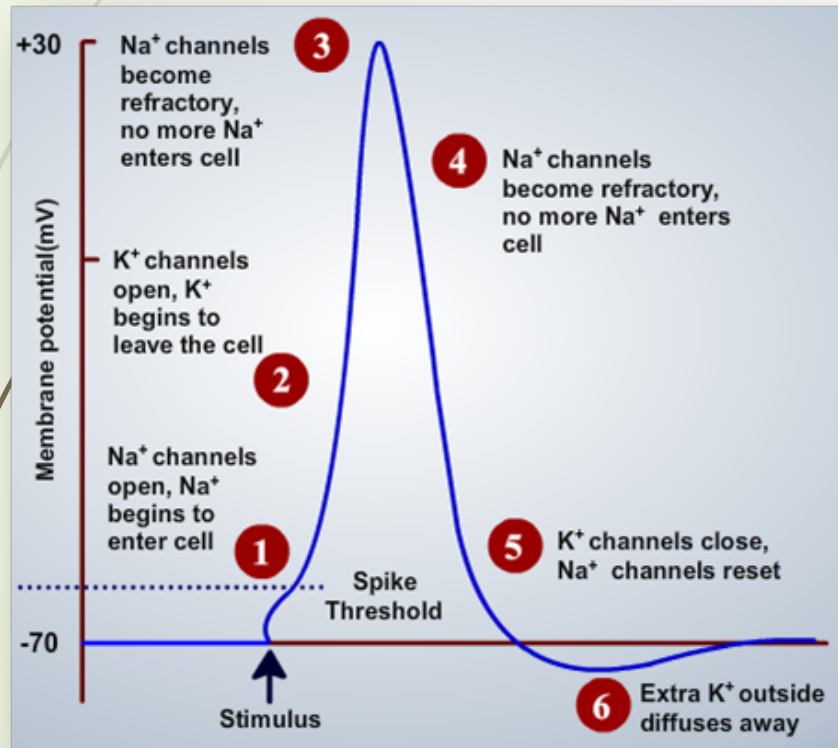

Hodgkin and Huxley model

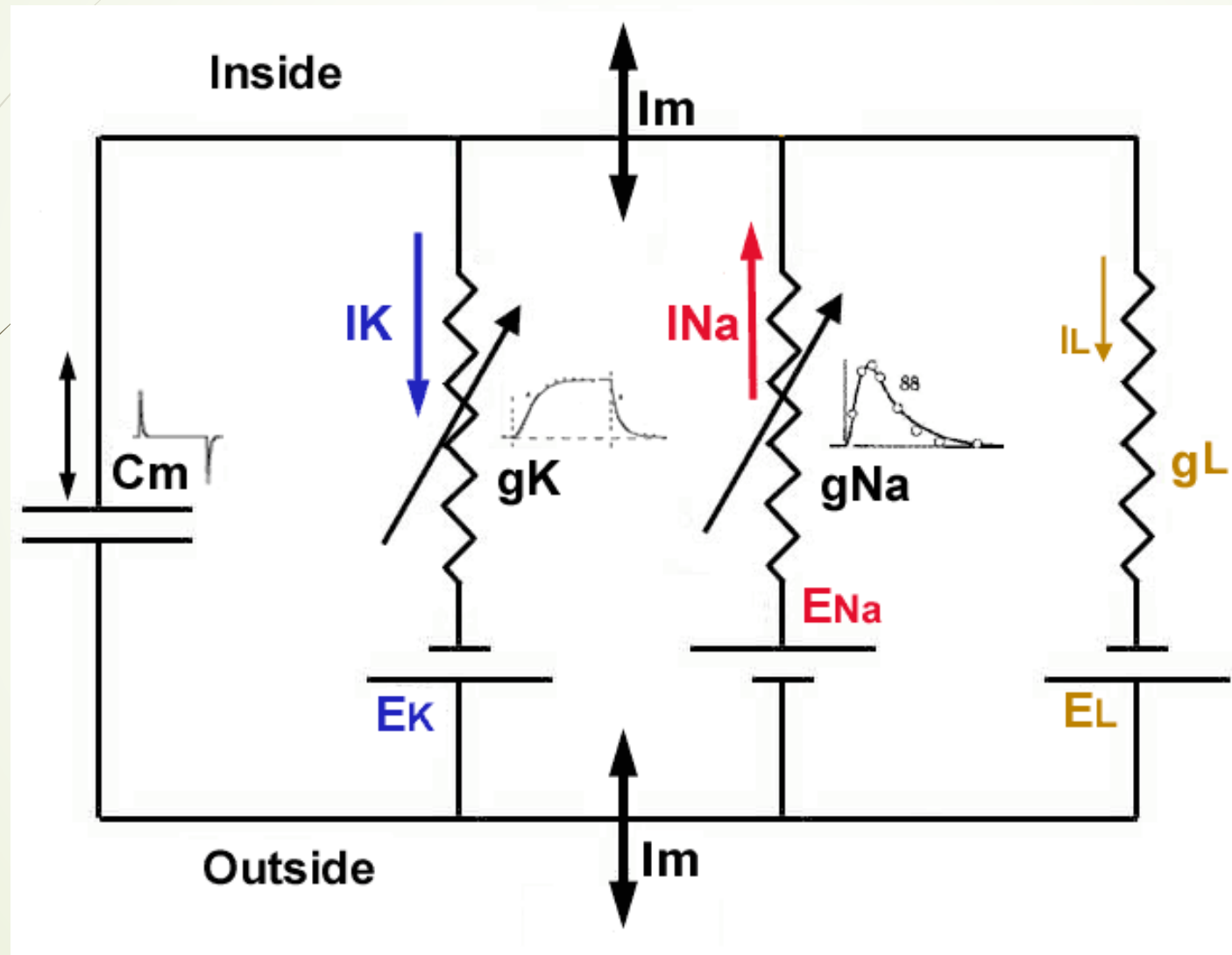

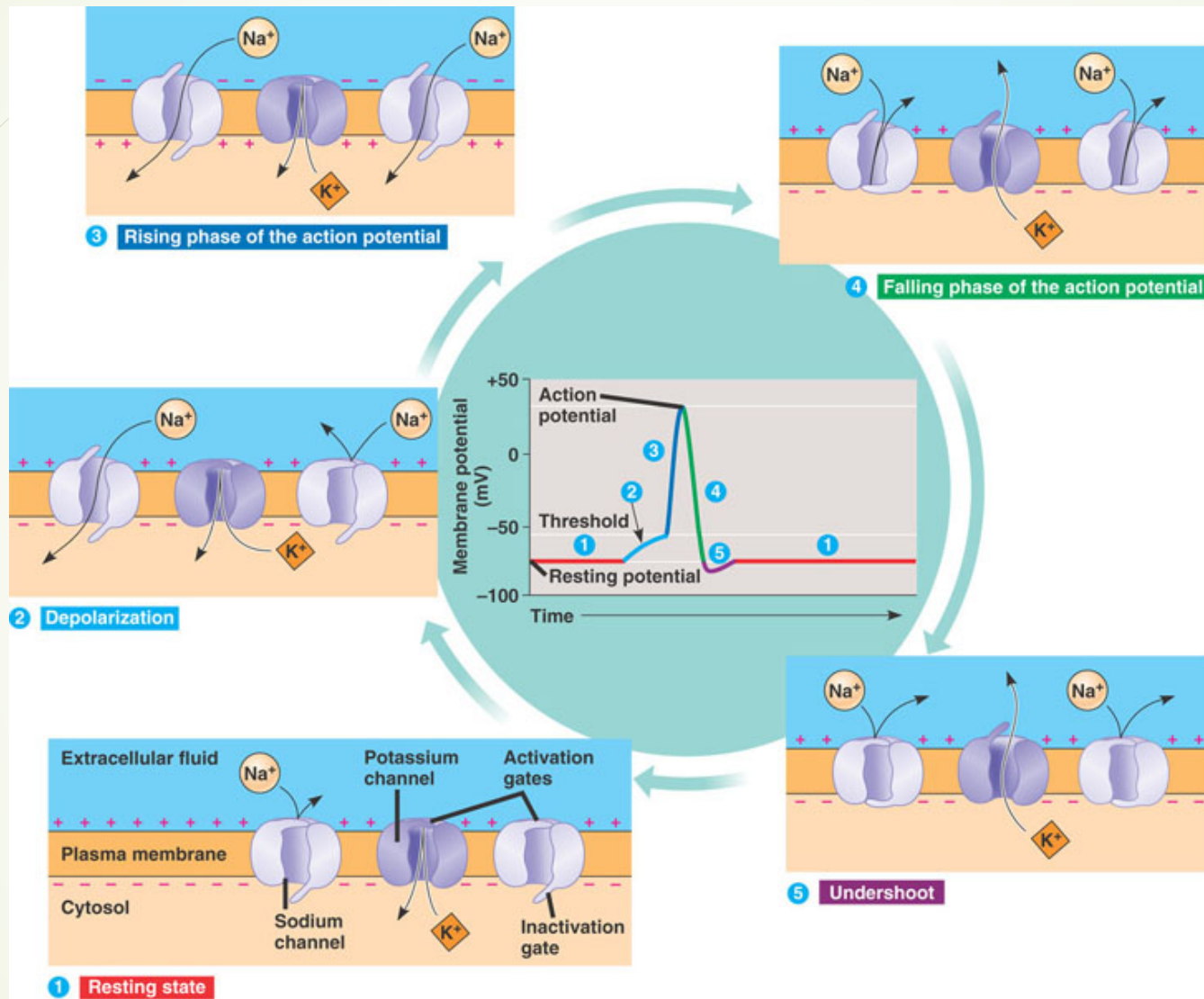

Excitable cells express high densities of VOCs and fire action potentials

neurons
muscle cells
secretory cells

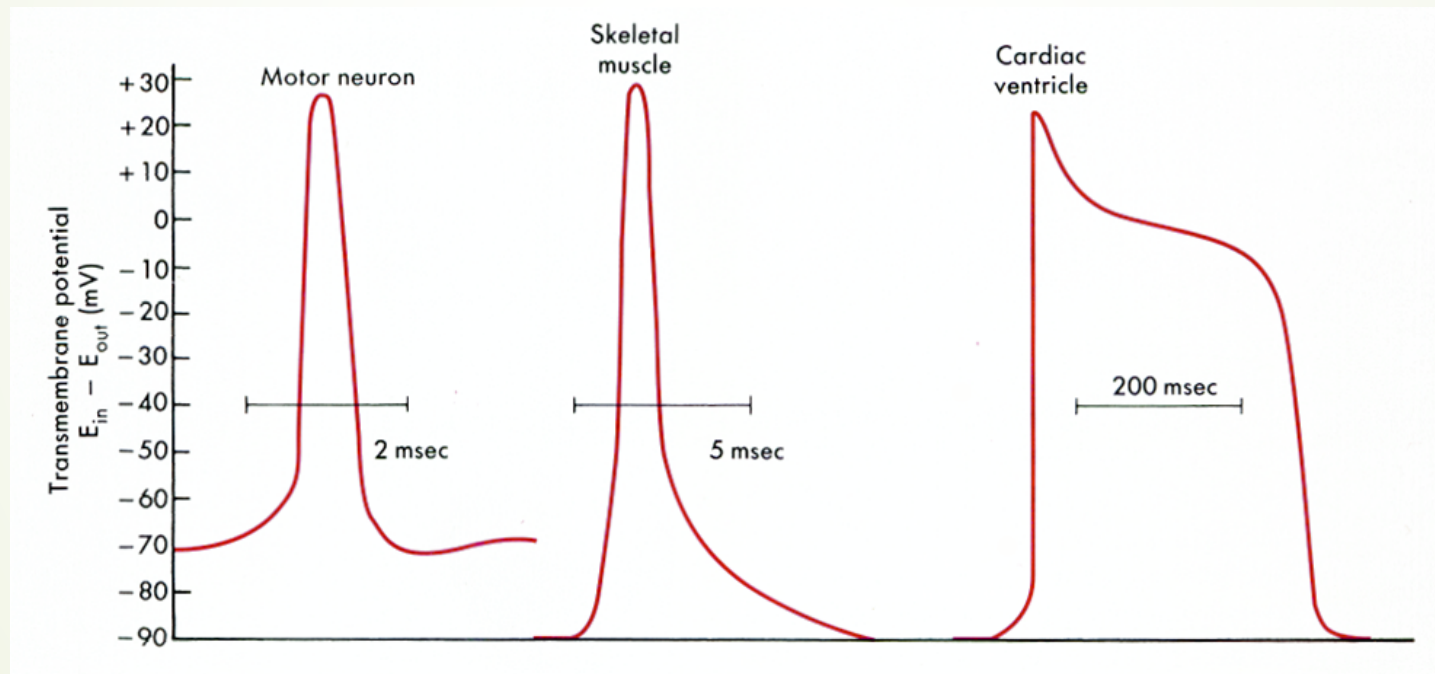

PdA with very different kinetics!

Cardiac Action Potentials

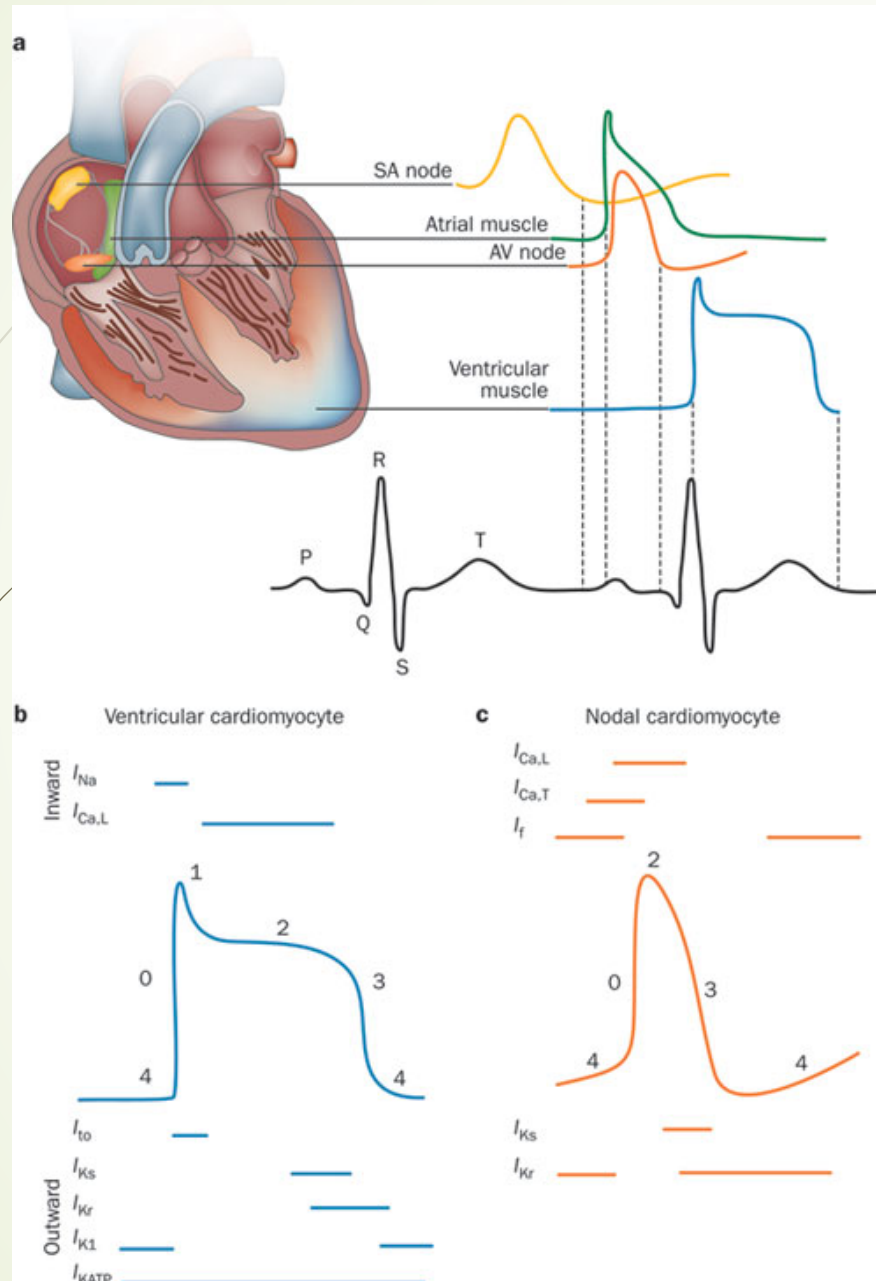

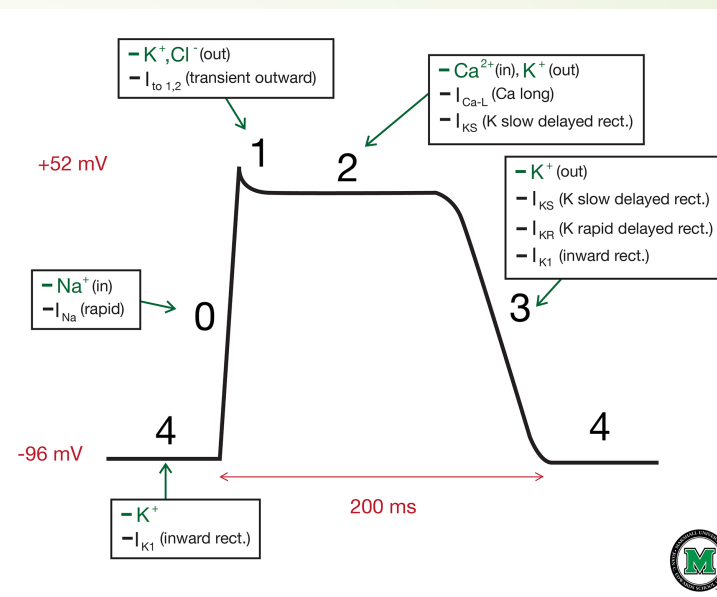
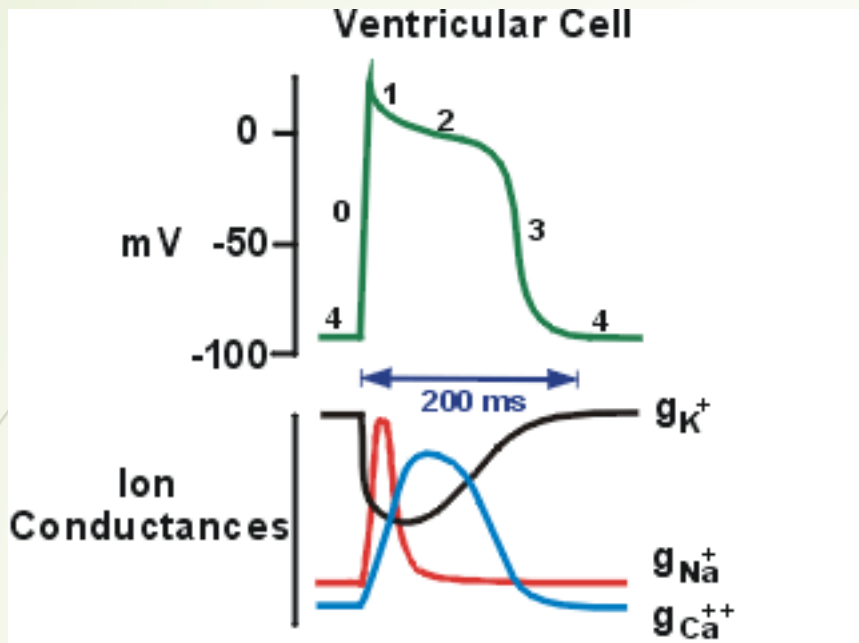

(b) Cardiac muscle

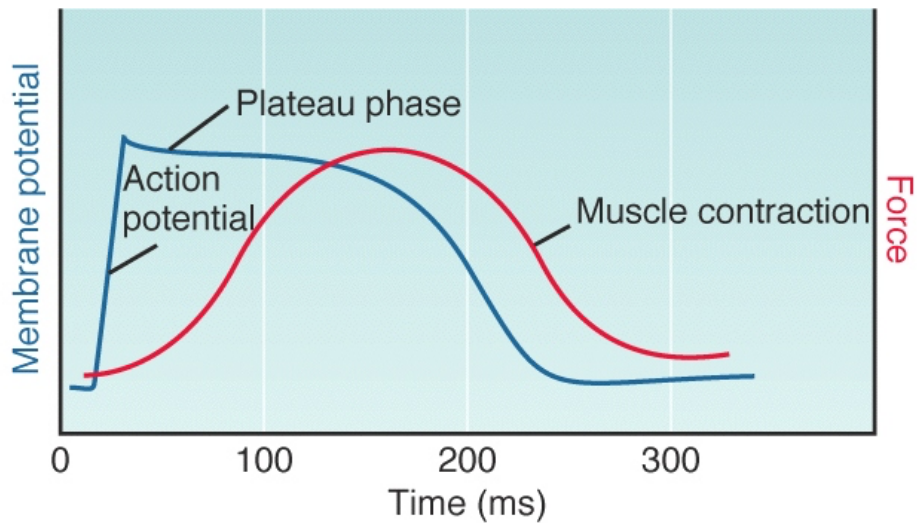

Long-lasting ventricular PdA

Propagation of signal conduction

Distance is not a relevant factor in the propagation of a signal in neuron's soma because the cell body can be approximated to a tiny sphere whose membranes voltage is uniform.

However when considering the signal travelling along extended structures such as dendrites, axons and muscle fibers, the signal decrease in amplitude with distance from the site of initiation.

Propagation of signal conduction

How geometry influences the distribution of current

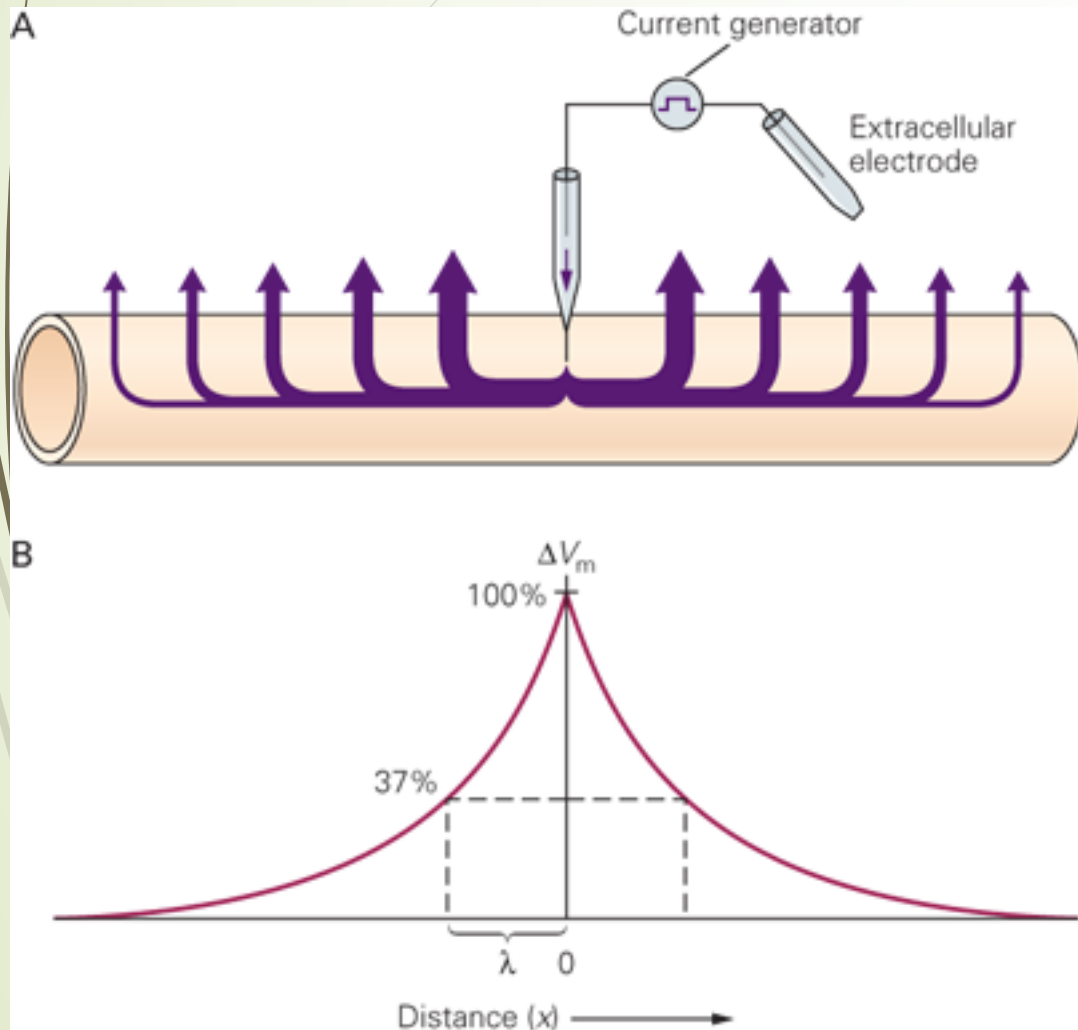

The variation of the V_m with distance depends on the relative value of the **membrane resistance** in a unit length of dendrite, r_m (units $\Omega \cdot \text{cm}$) and internal neuron resistance per unit length of the dendrite, r_i (units Ω/cm).

The change in V_m becomes smaller with distance along the dendrite away from the electrode. The decay with distance is exponential:

$$V_x = V_0 e^{-\frac{x}{\lambda}}$$

$$\lambda = \sqrt{\frac{r_m}{r_i}}$$

LENGTH CONSTANT

RESISTANCE OF NEURON MEMBRANE

INTERNAL NEURON RESISTANCE

Propagation of signal conduction

How geometry influences the distribution of current

$$\lambda = \sqrt{\frac{r_m}{r_i}}$$

LENGTH CONSTANT

RESISTANCE OF NEURON MEMBRANE

INTERNAL NEURON RESISTANCE

The better the insulation of the membrane (the greater r_m), the better the conducting properties of the inner core (the lower r_i), the greater the length constant of the dendrite

Myelination changes PdA propagation:
it increases resistance of neuron membrane (r_m)

LENGTH CONSTANT

$$\lambda = \sqrt{\frac{r_M}{r_I}}$$

RESISTANCE OF NEURON MEMBRANE

INTERNAL NEURON RESISTANCE

► Myelination of PNS and CNS Axons

Myelination in the Peripheral Nervous System

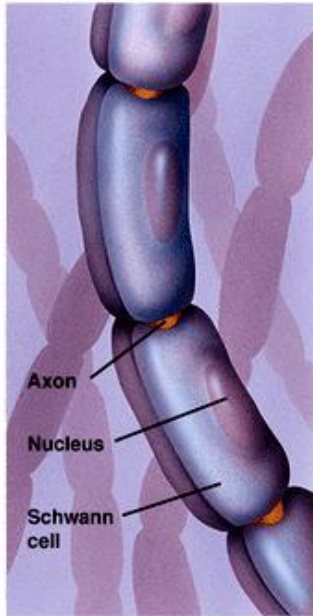

Myelination in the Central Nervous System

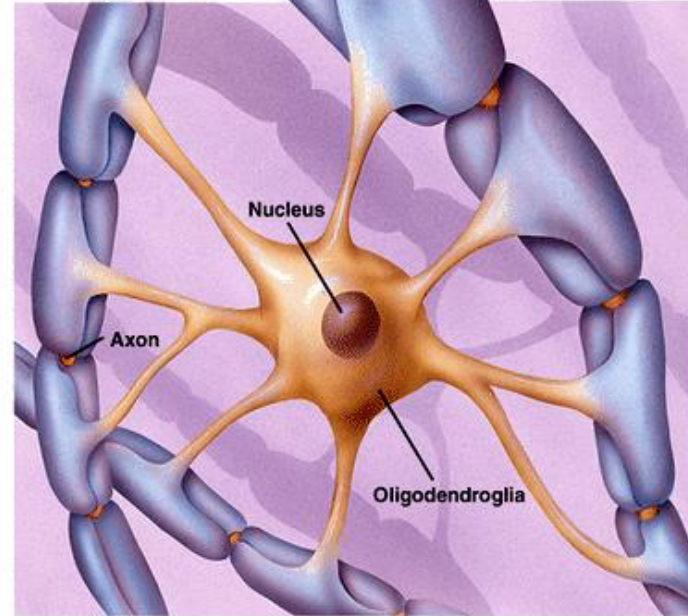

Propagation of signal conduction

The length constant is also a function of the diameter of the neuronal process

For neuronal processes with similar ion channels density and cytoplasmic composition, the larger the diameter, the longer is the length constant.

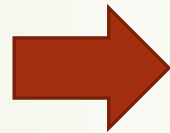

Thicker axons and dendrites have longer length constant than do narrower processes
Can **transmit signals for greater distances**

$$r_m \text{ (units } \Omega * \text{ cm)}$$
$$r_i \text{ (units } \Omega/\text{cm)}$$

$$\lambda = \sqrt{\frac{r_m}{r_i}}$$

LENGTH CONSTANT

RESISTANCE OF NEURON MEMBRANE

INTERNAL NEURON RESISTANCE

Propagation of signal conduction: electrotonic conduction

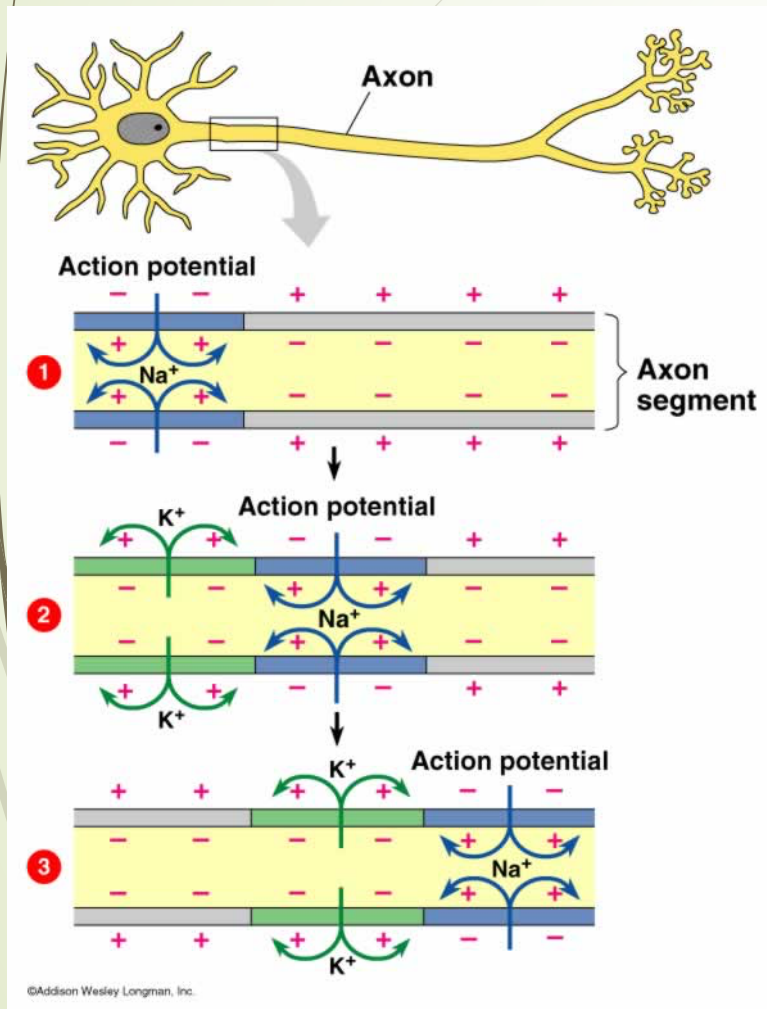

The electrotonic conduction is a factor in the propagation of action potential. Once the membrane at any point along the axon has been depolarized beyond threshold, an action potential is generated in that region. This local depolarization spreads passively down the axon, causing a successive adjacent regions of the membrane to reach the threshold for generating an action potential

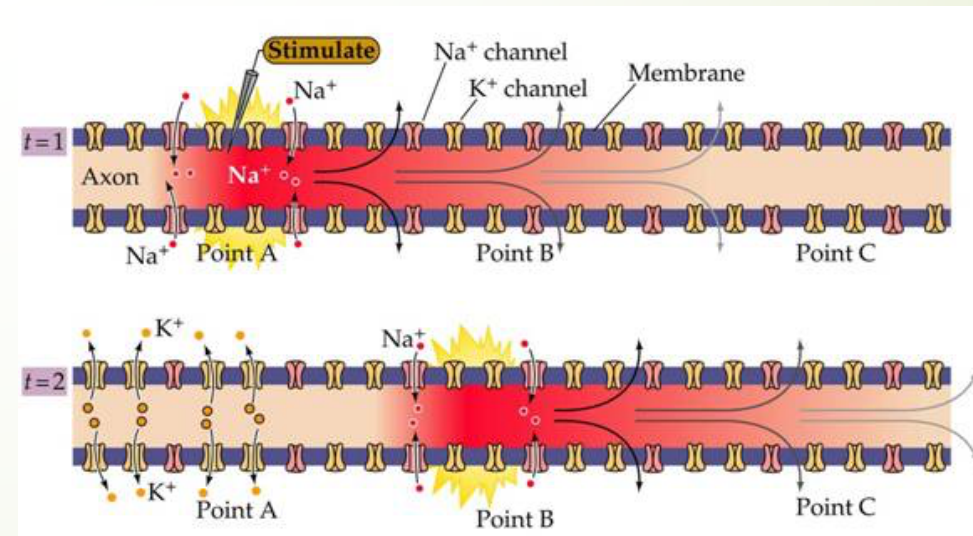

Propagation of signal conduction: electrotonic conduction

The electrotonic conduction is a factor in the propagation of action potential. Once the membrane at any point along the axon has been depolarized beyond threshold, an action potential is generated in that region. This local depolarization spreads passively down the axon, causing a successive adjacent regions of the membrane to reach the threshold for generating an action potential

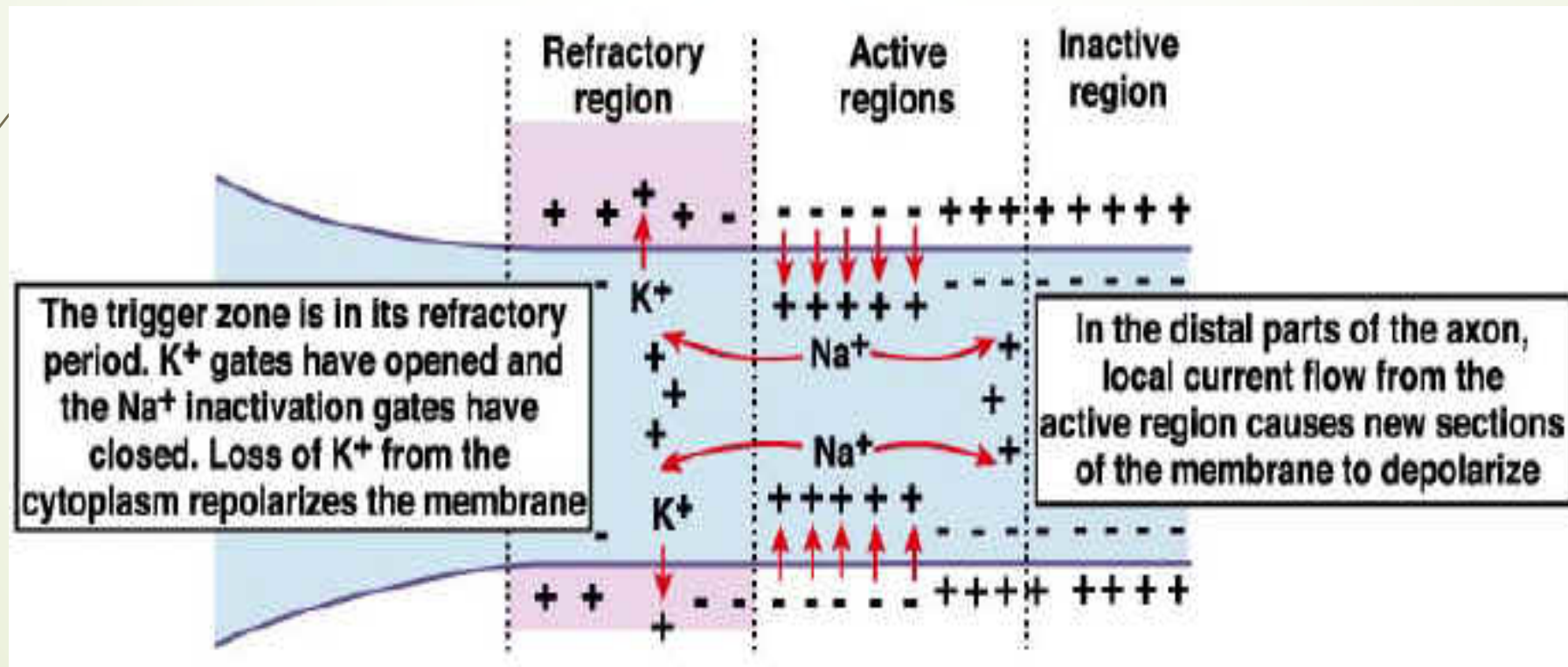

Rapid Propagation of signal conduction:

Neurons have adopted an adaptive strategy to allow a rapid conduction propagation by wrapping a myelin sheath around the axonal membrane. On the other hand the PdA is triggered in a non myelinated initial segment of membrane just distal to the axon hillock.

Even though the capacitance of the axon is quite small (because of the myelin insulation), the amount of current down the core of the axon from the trigger zone is not enough to discharge the capacitance along the entire length of the myelinated axon

Saltatory conduction: nodes of Ranvier.

The myelin sheath is interrupted every 1 or 2 mm by bare patches of axon membrane approximately $1\mu\text{m}$ in length

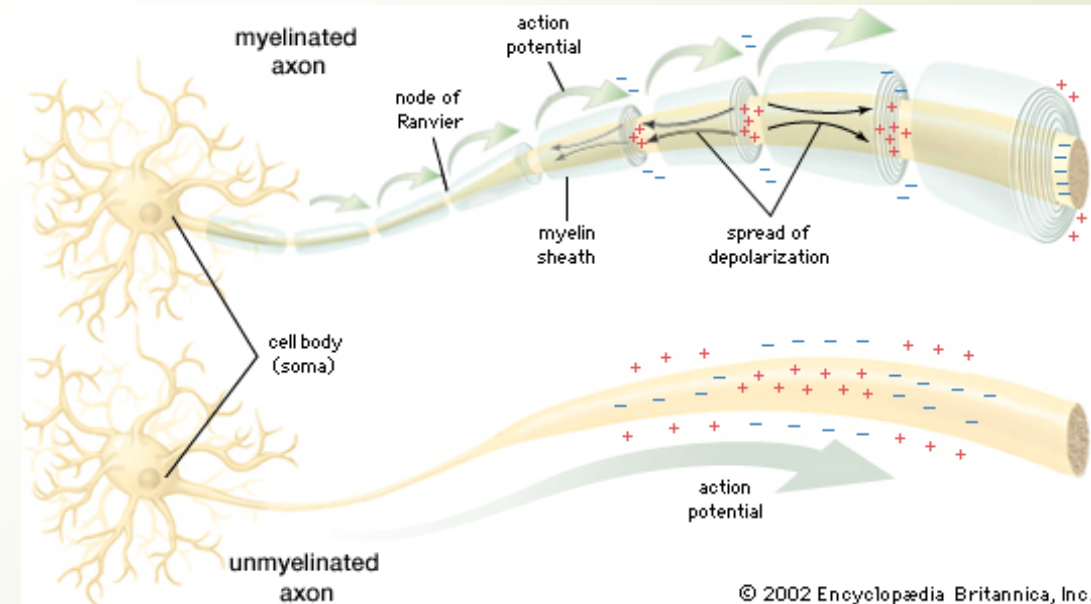

Rapid Propagation of signal conduction:

Although the area of the nodal membrane at each node is quite small, the nodal membrane is rich of voltage-gated Na^+ and K^+ channels and thus can generate an intense depolarizing inward Na^+ current in response to the passive spread of depolarization down along the axon

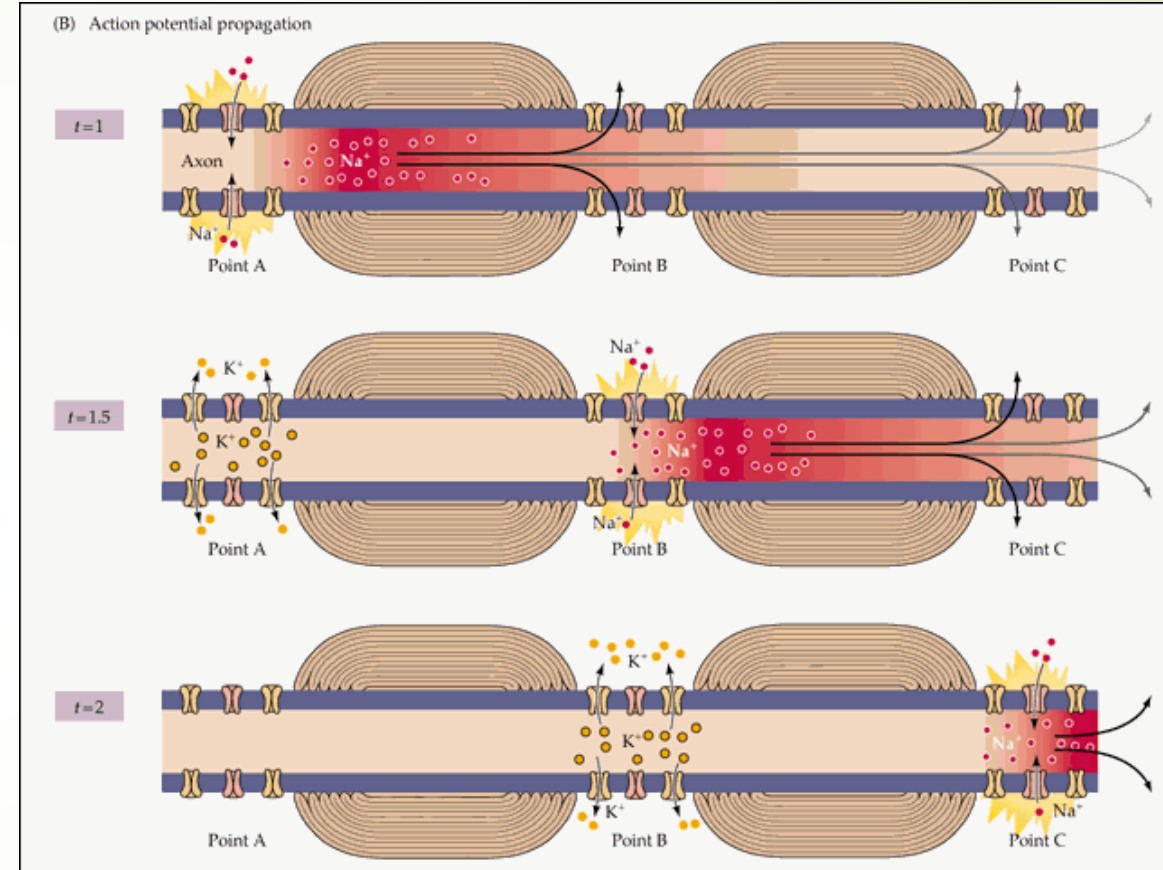

➔ The Ranvier nodes Boost the amplitude of the depolarization periodically, preventing it from decaying with distance

Rapid Propagation of signal conduction:

Because ionic membrane current flows only at the nodes in myelinated fibers, saltatory conduction is also favorable from the metabolic standpoint. Less energy must be expected by the $\text{Na}^+\text{-K}^+$ pump in restoring the Na^+ and K^+ concentration gradients, which tend to run down as the Action potential is propagated

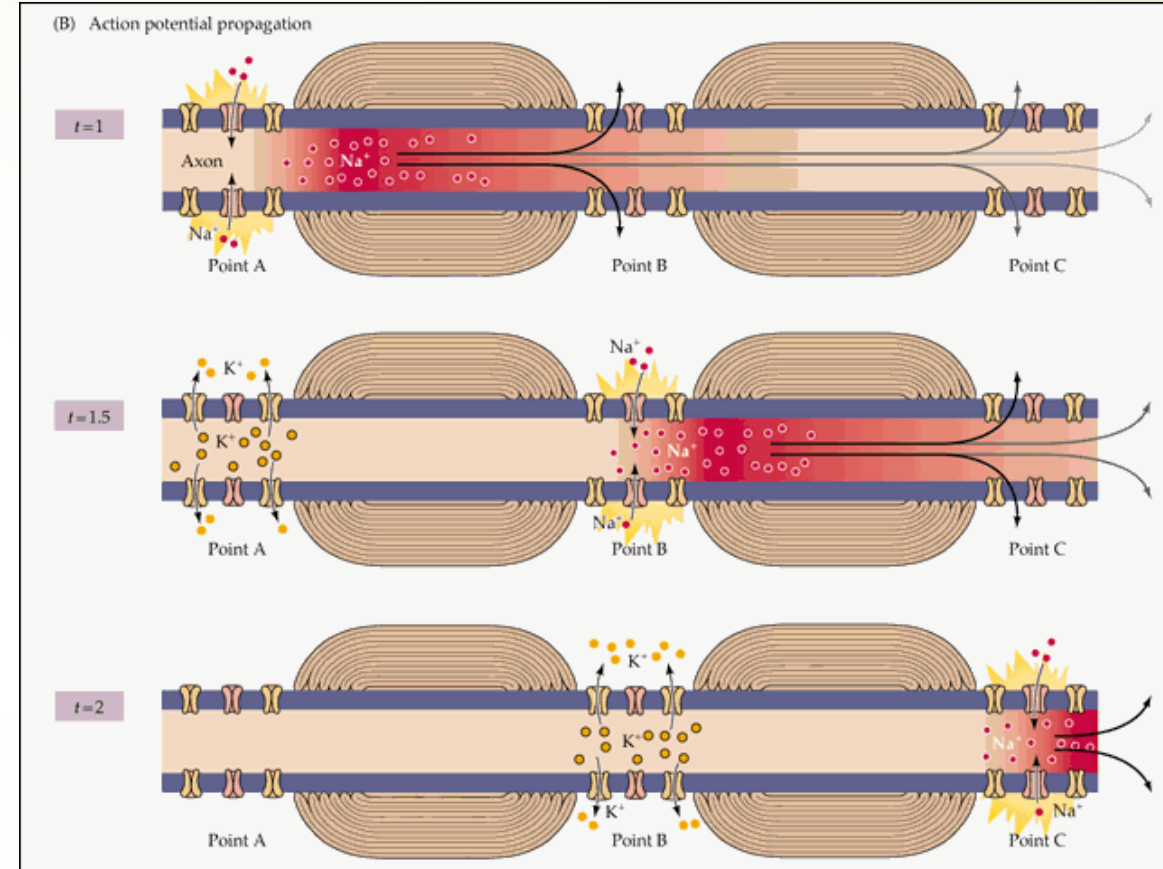

Rapid Propagation of signal conduction:

Various diseases are caused by demyelination, such as multiple sclerosis and Guillain-Barré syndrome.

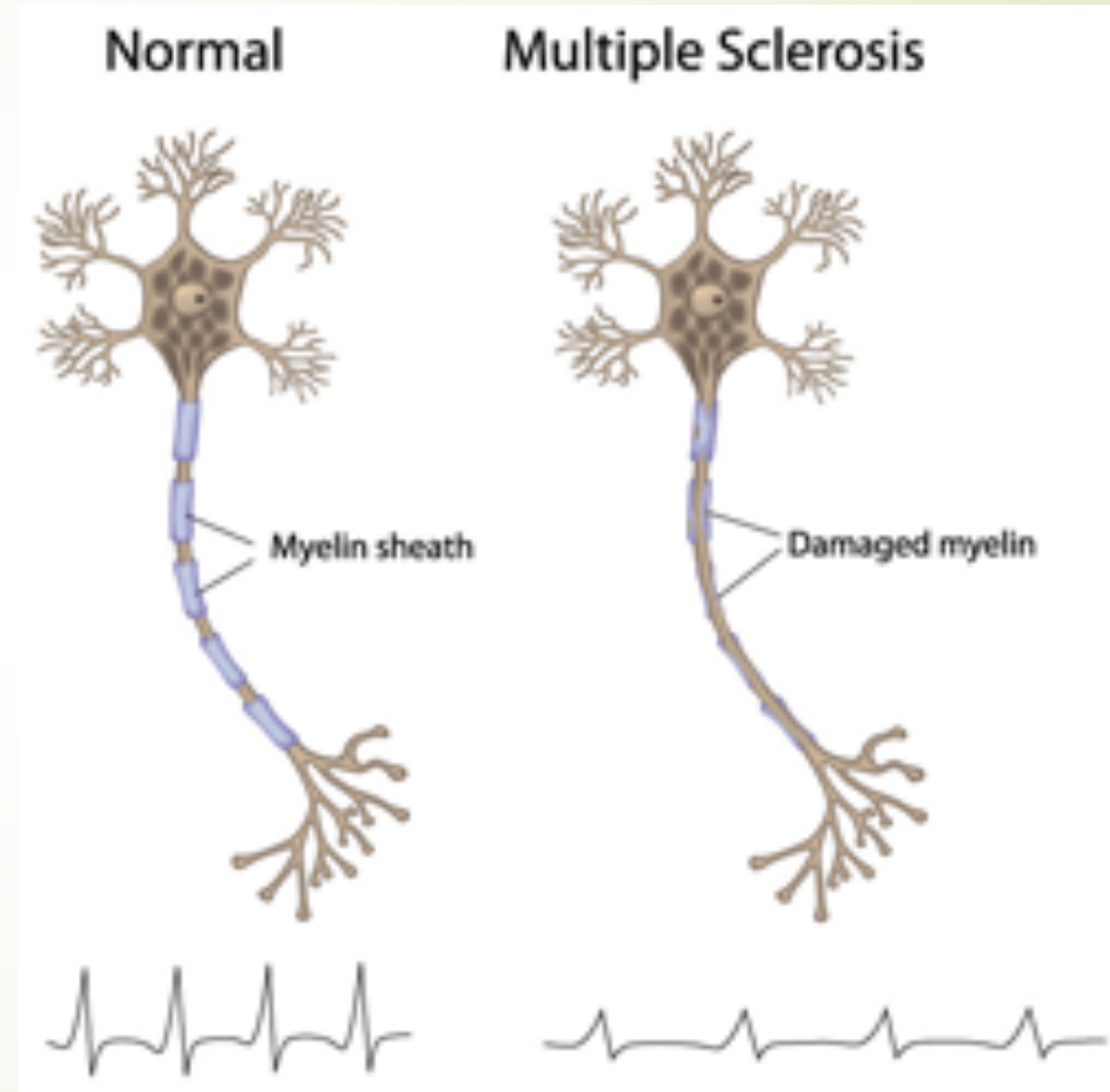

PATCH CLAMP technique

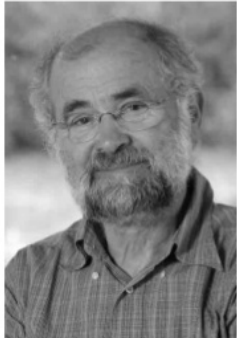

•Erwin Neher and Bert Sakmann developed the patch clamp in the late 1970s and early 1980s. They received the Nobel Prize in Physiology or Medicine in 1991 for this work.

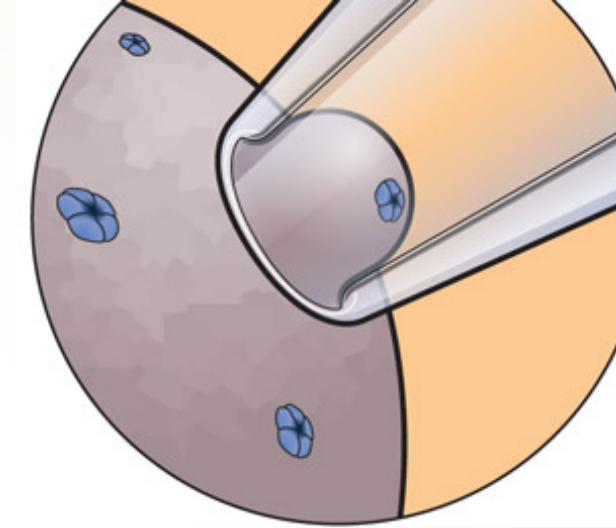

Measurement of ionic currents flowing through the entire plasma membrane of a cell or a SINGLE CHANNEL:
CHANNEL:
high resistance seal

A single protein (channel) changes conformation!!

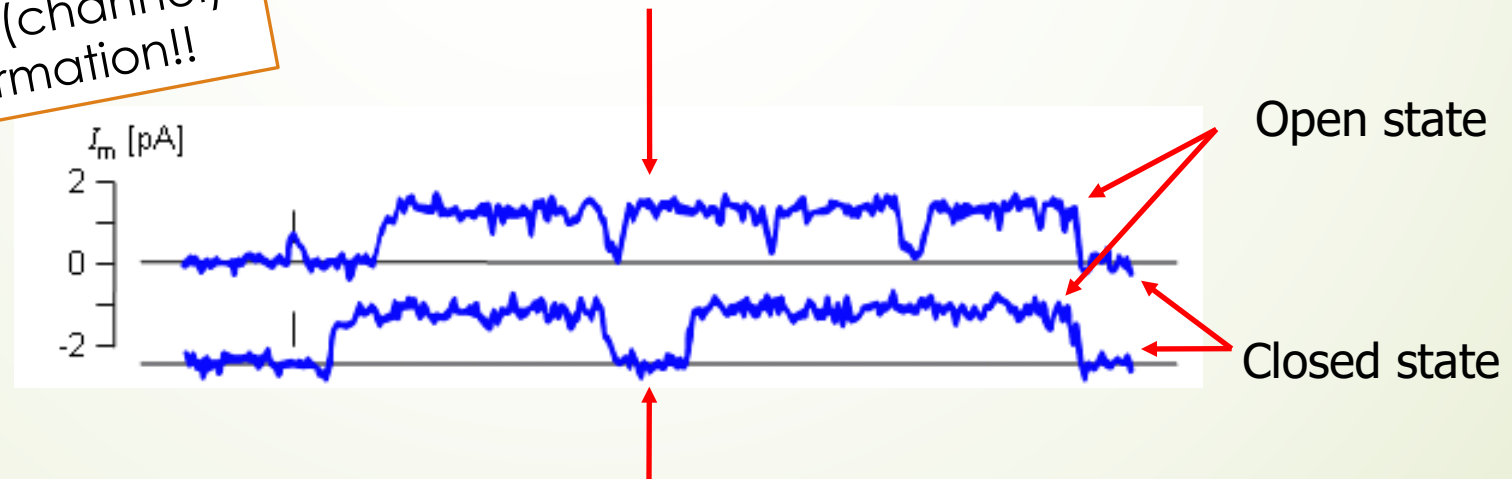

Patch-Clamp

- The diameter of the capillary tip is about $0,5 \mu\text{M}$
- The tip is filled with a saline solution (extra or intracellular depending on the configuration)

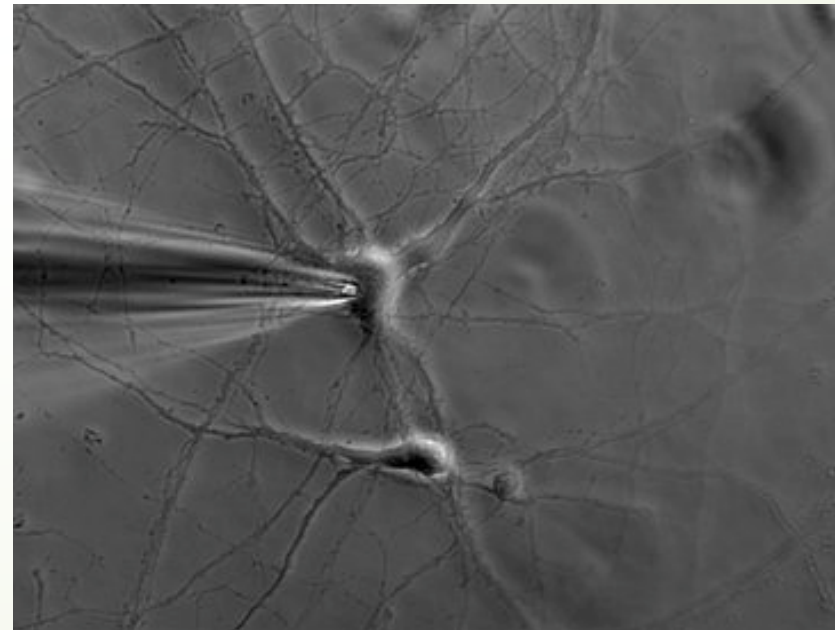
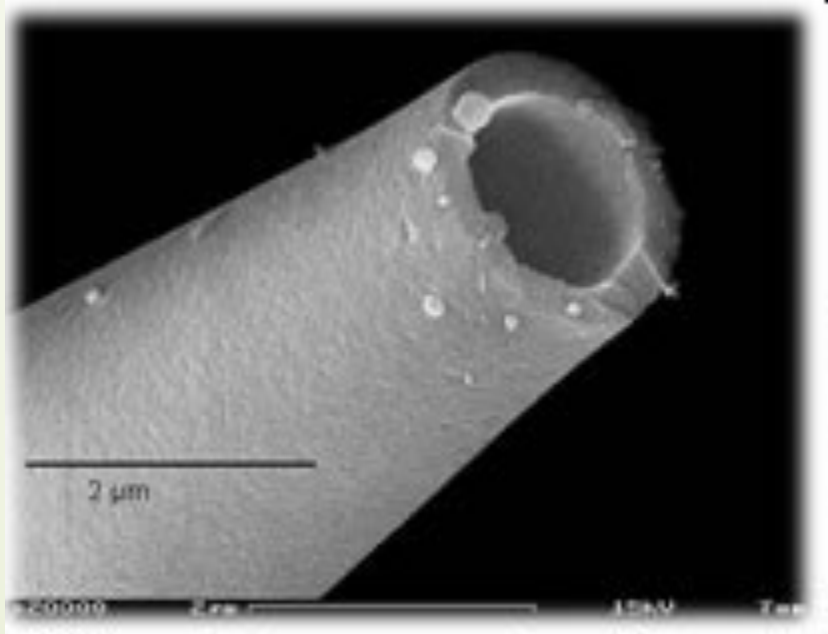

Patch-Clamp

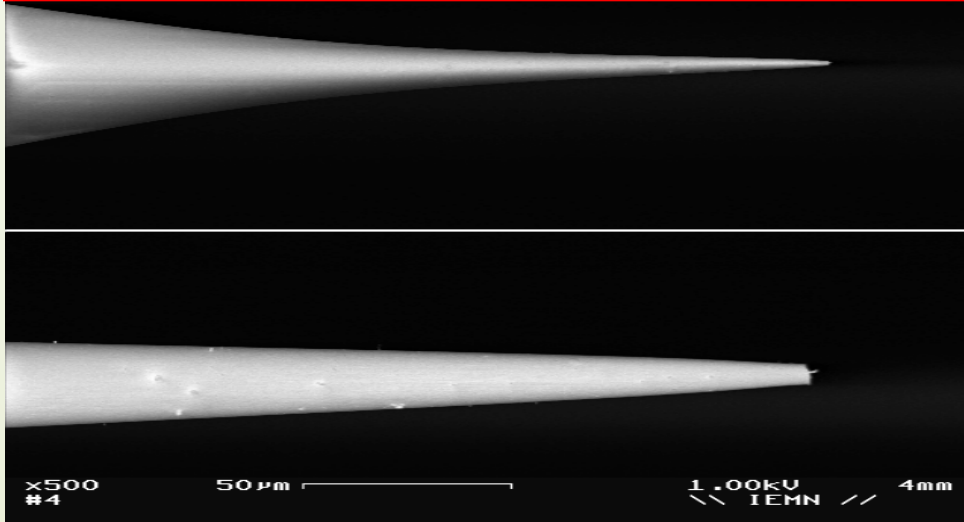
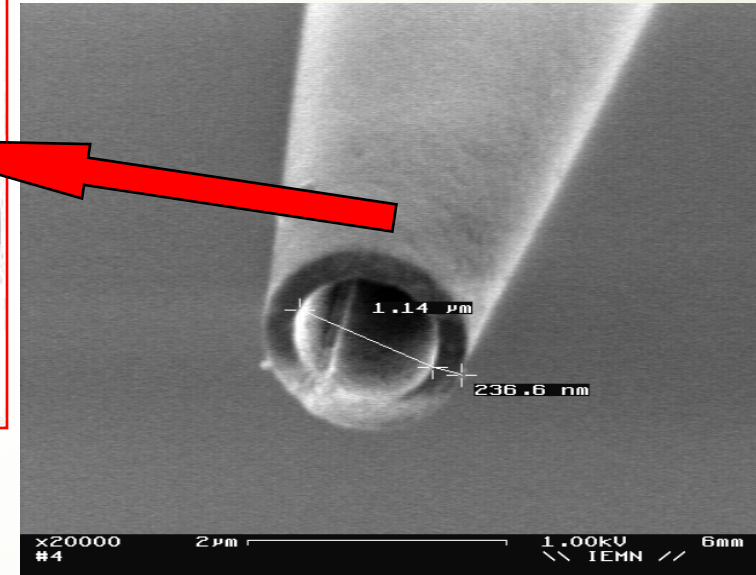
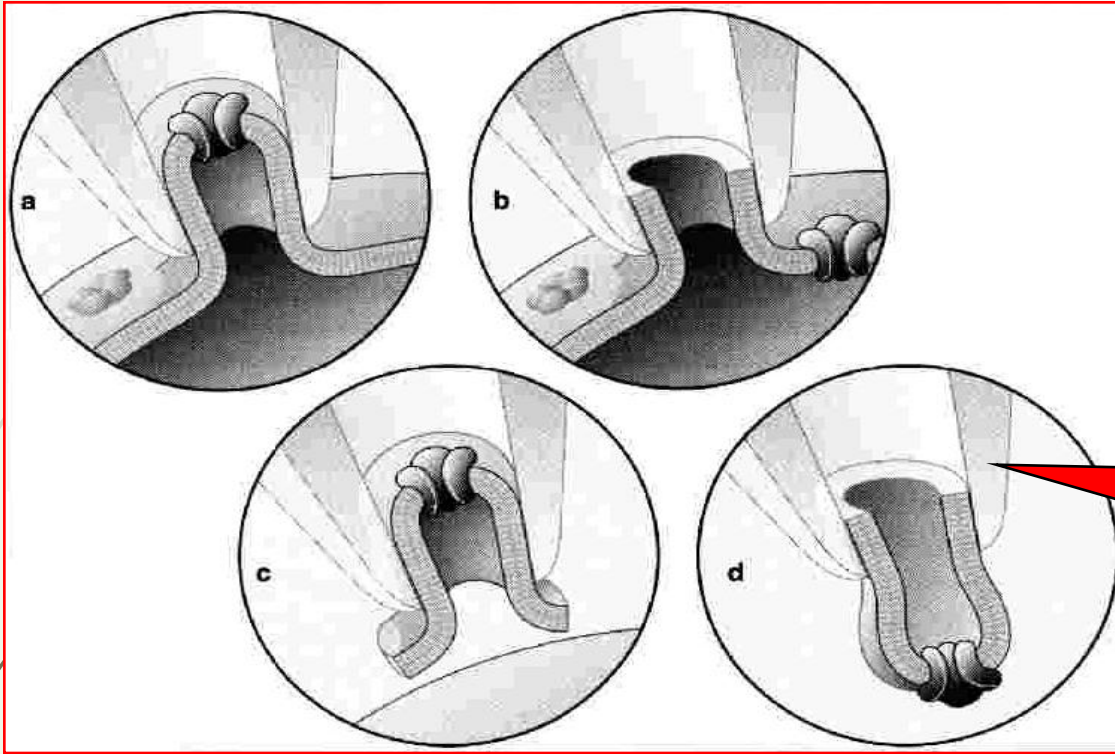

E_M -80 -40 mV membrane voltage stimulus

Unitary Na currents

0.5 pA

I_{Na}

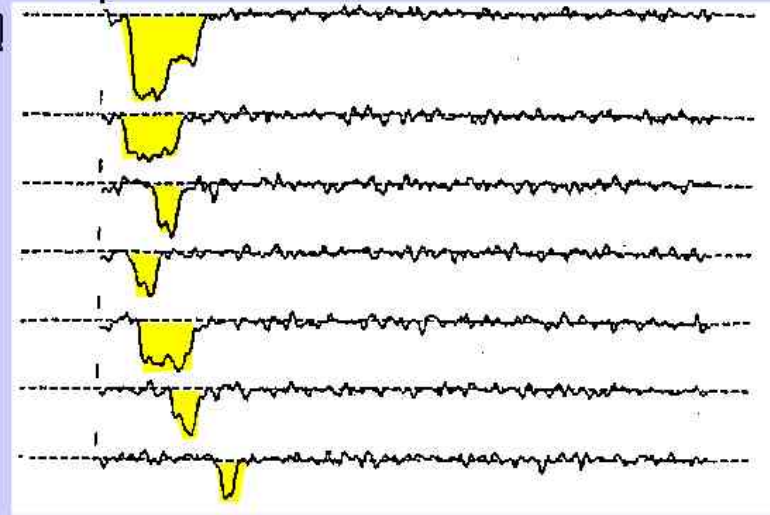

Ensemble average Na current

2 pA

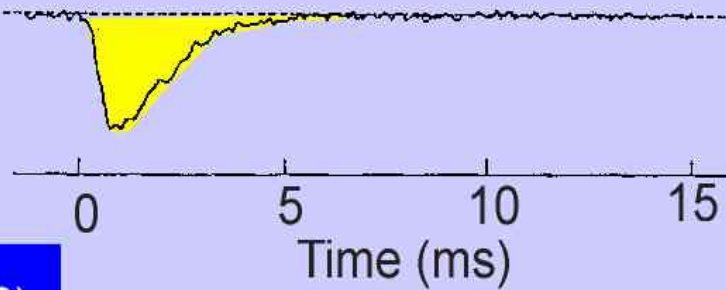

Patlak (1990)

Patch
Clamp
sees
single Ion
Channels
(Neher &
Sakmann,
1981)

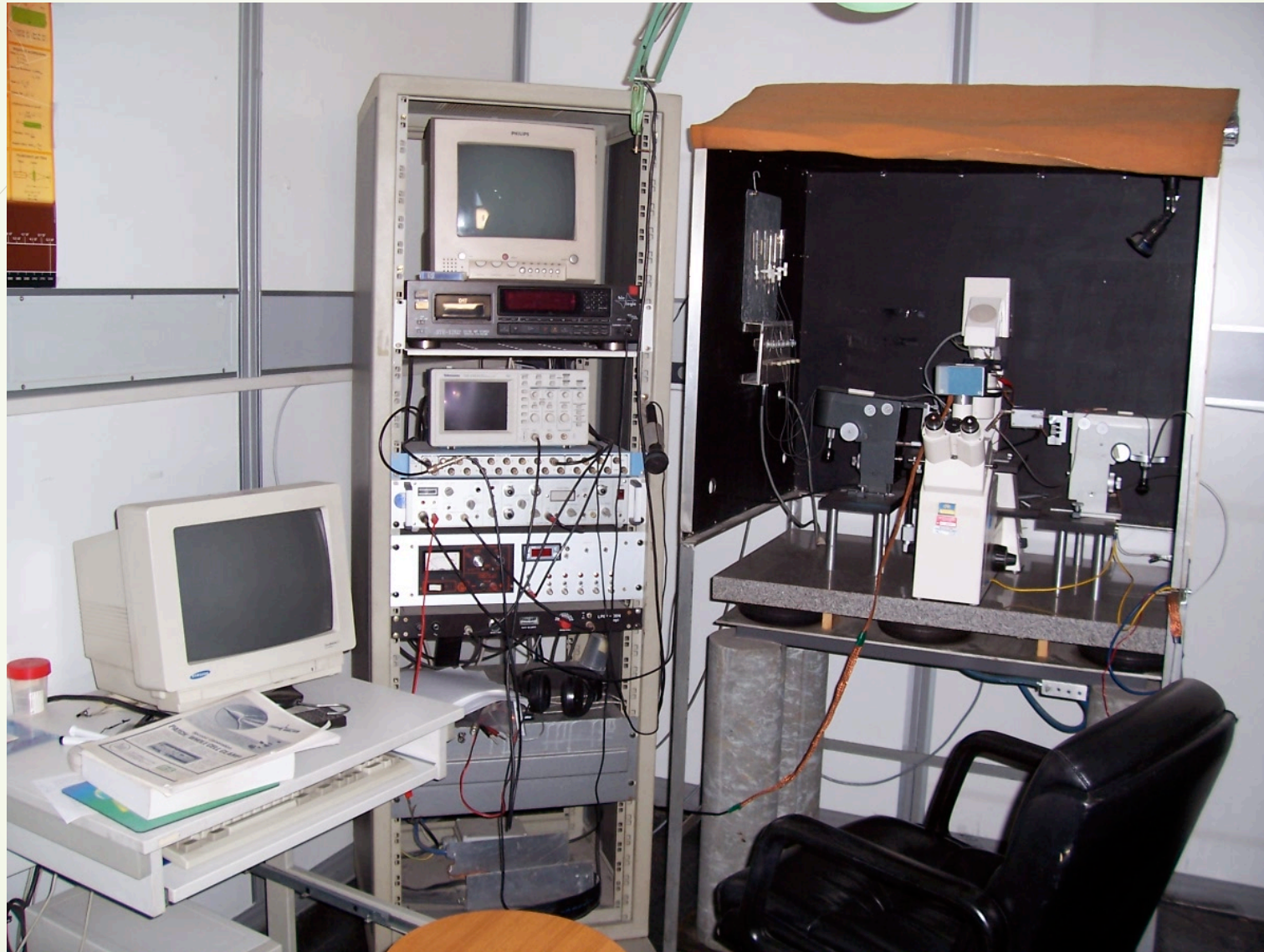

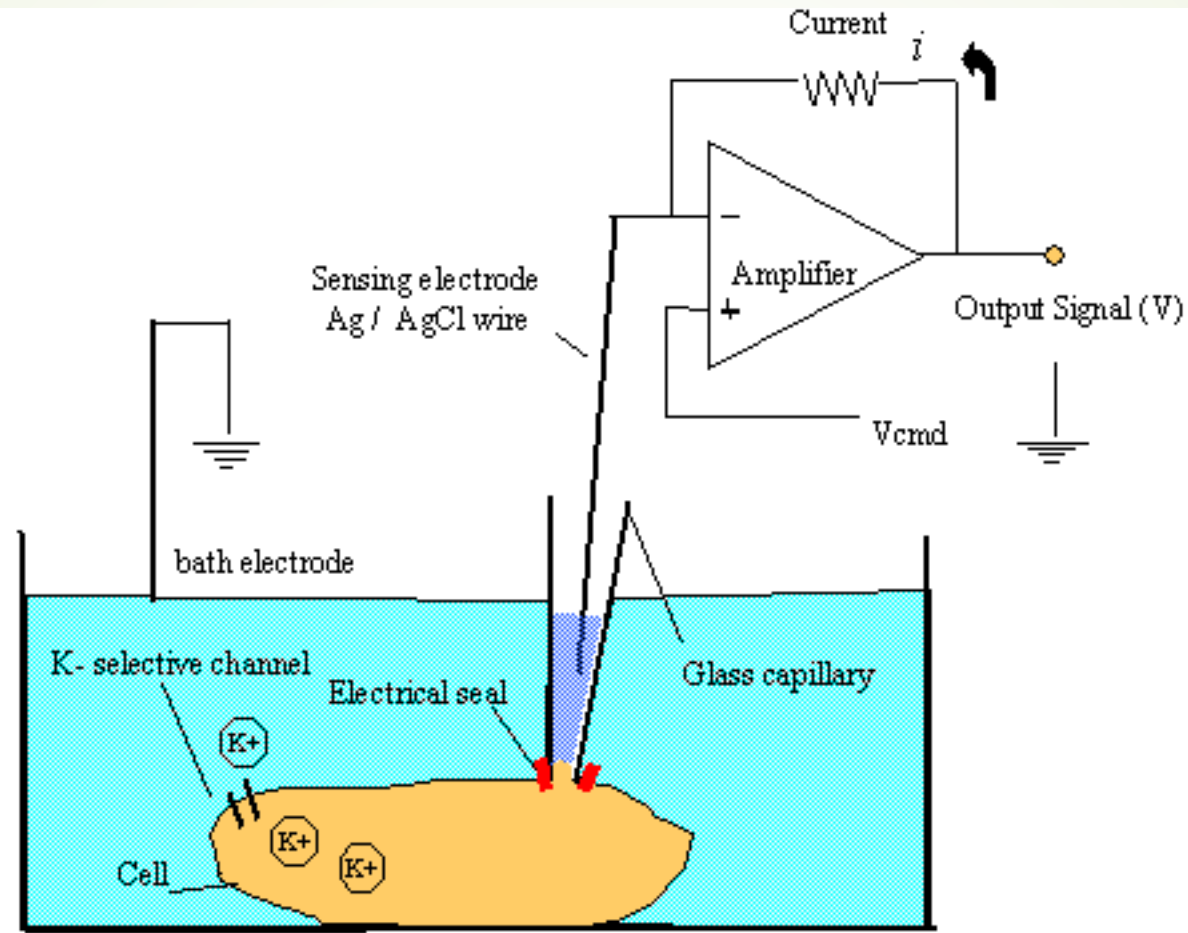

Functional depiction of classical patch-clamp electrophysiology

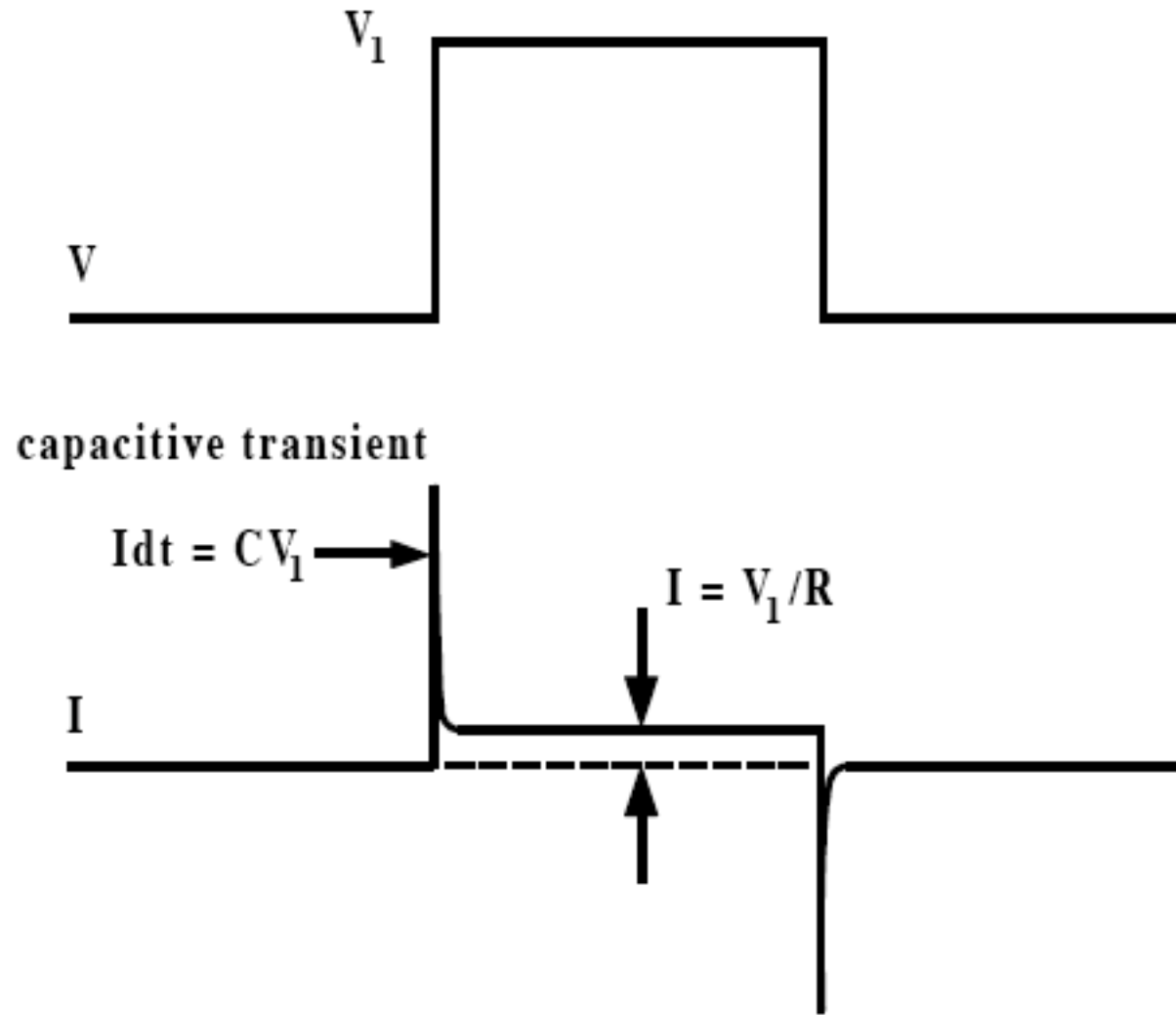

Figure 1-15. Typical Voltage-Clamp Experiment
A voltage-clamp experiment on the circuit of Figure 1-13.

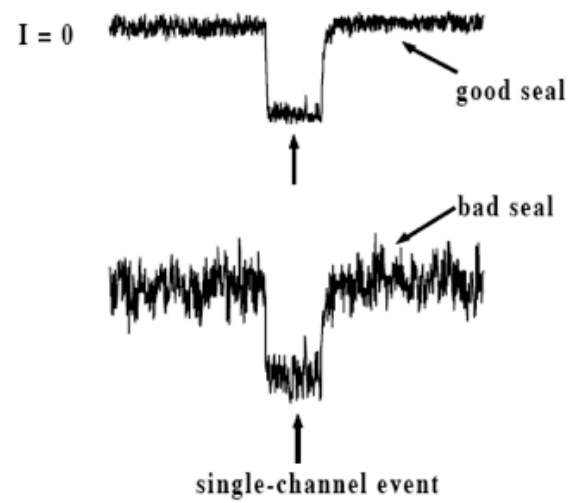
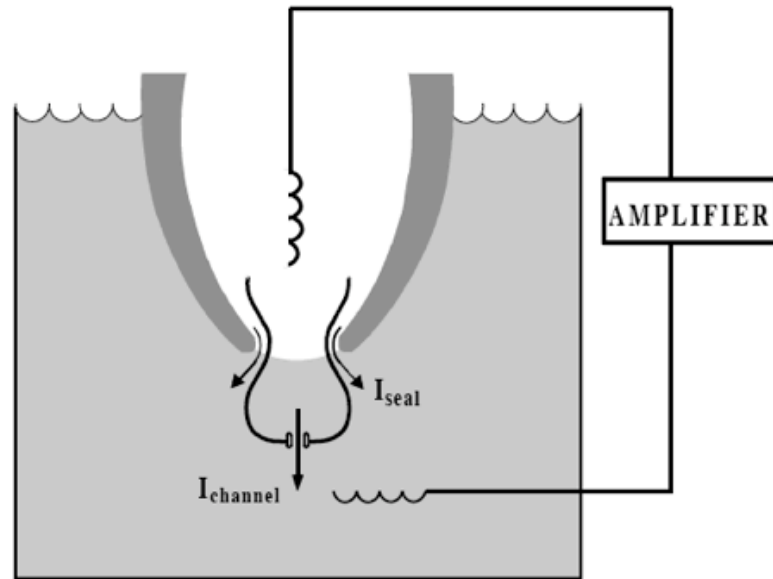
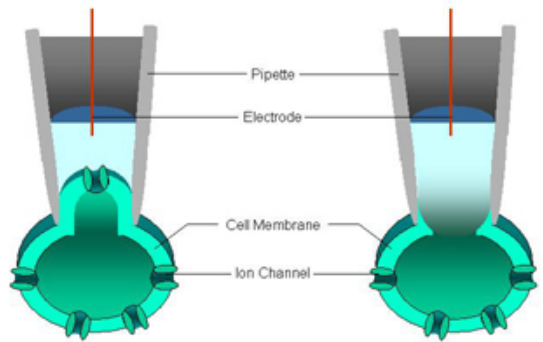

Figure 1-17. Good and Bad Seals

In a patch recording, currents through the seal also flow through the measuring circuit, increasing the noise on the measured current.



Cell-attached Mode

Whole-cell Mode

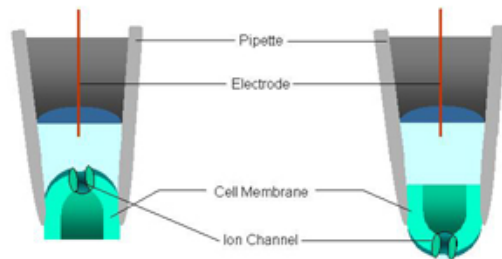

Inside-out Mode

Outside-out Mode

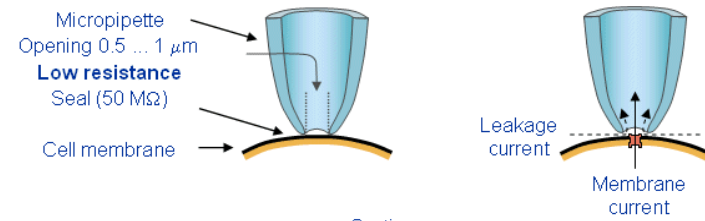

Cell-attached recording

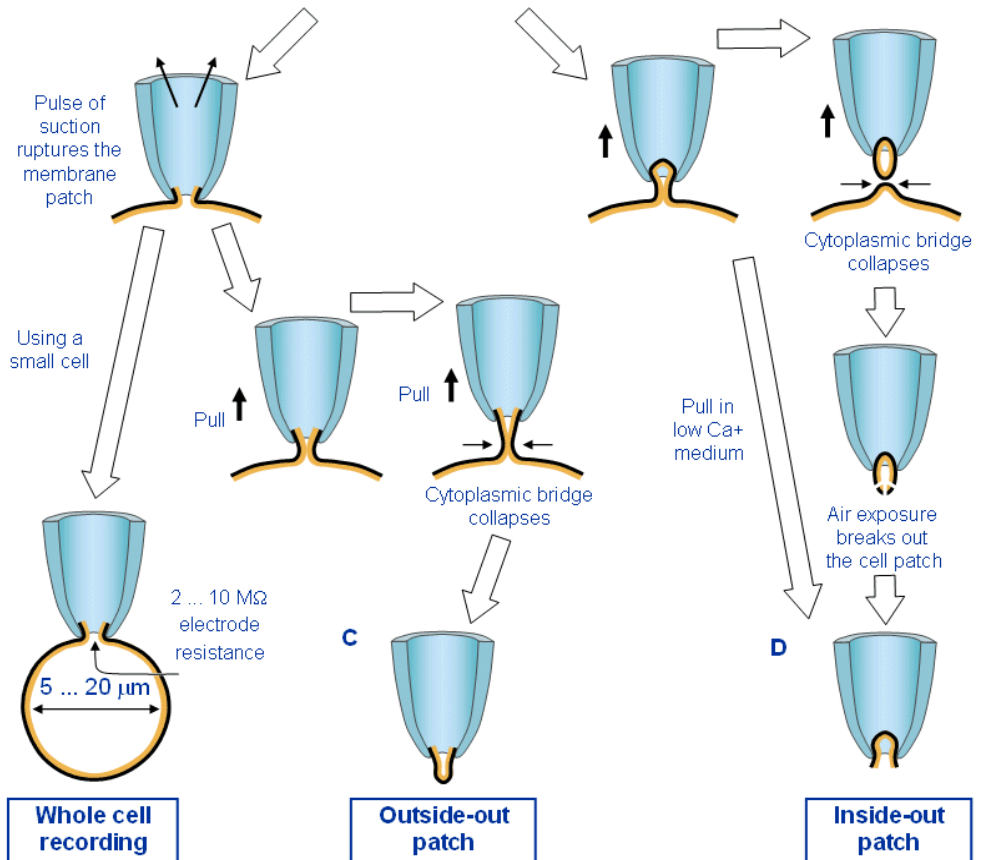
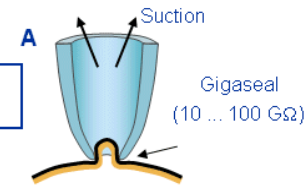

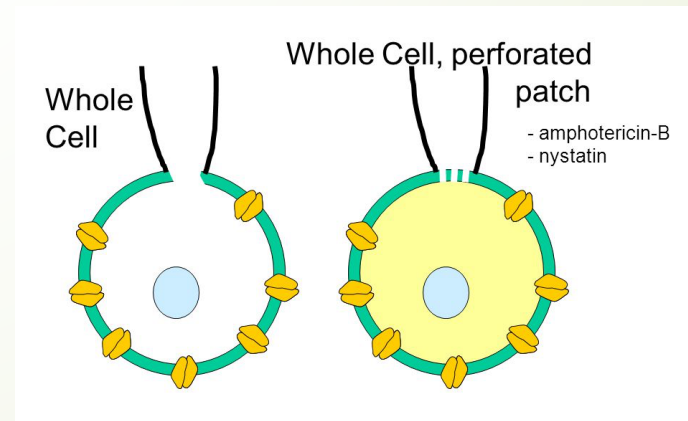
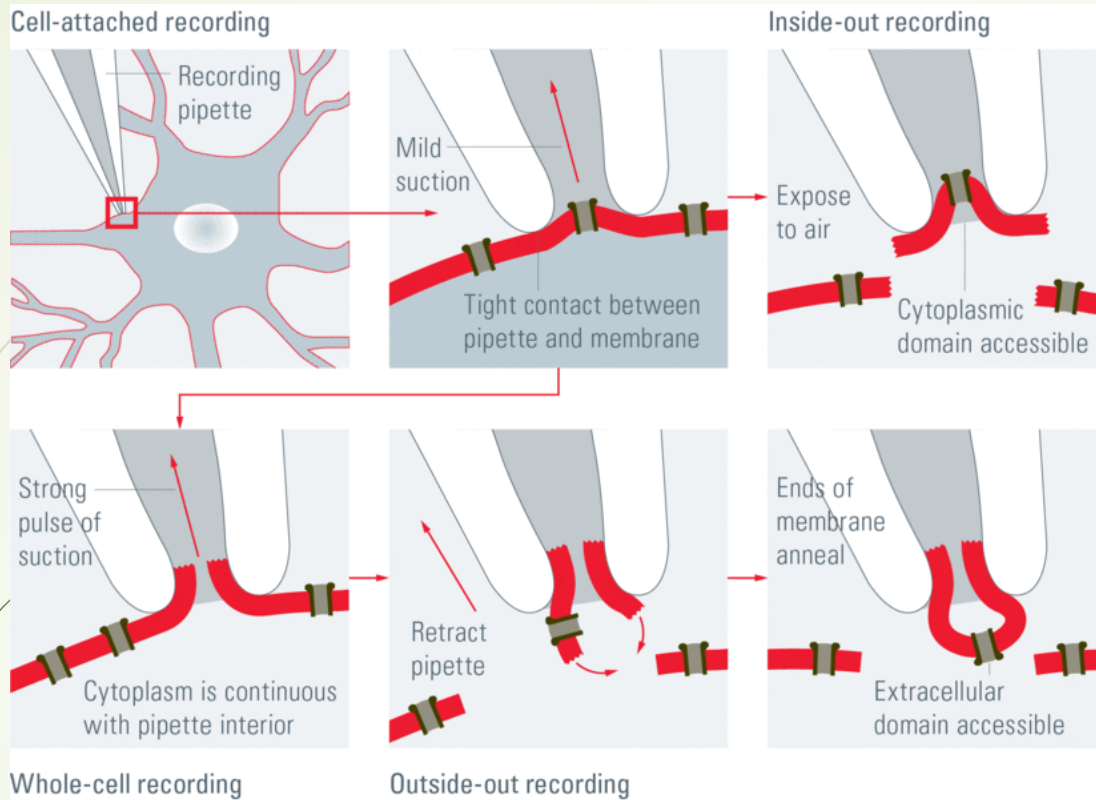

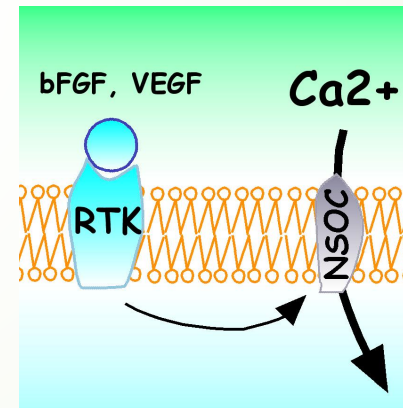
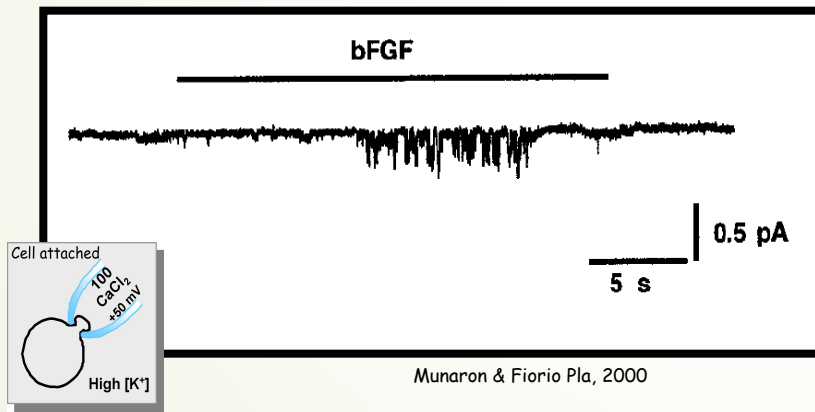
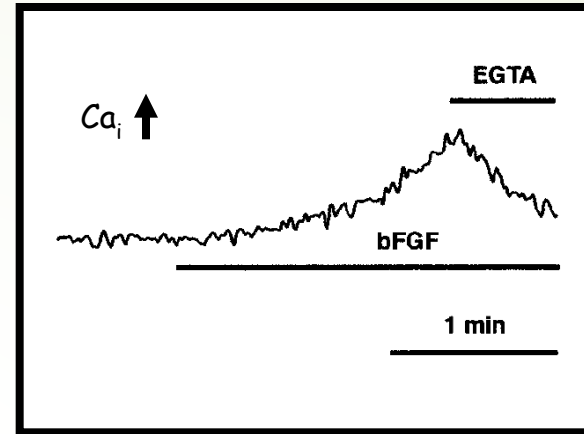
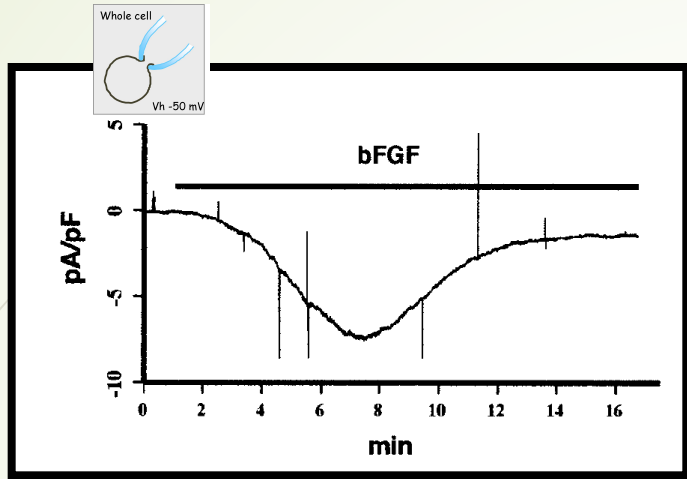

AA is able to activate NSOCs in BAECs

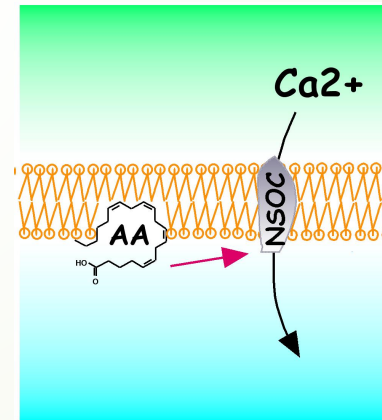
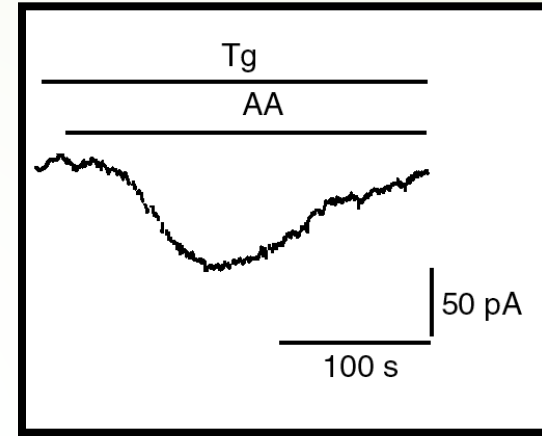
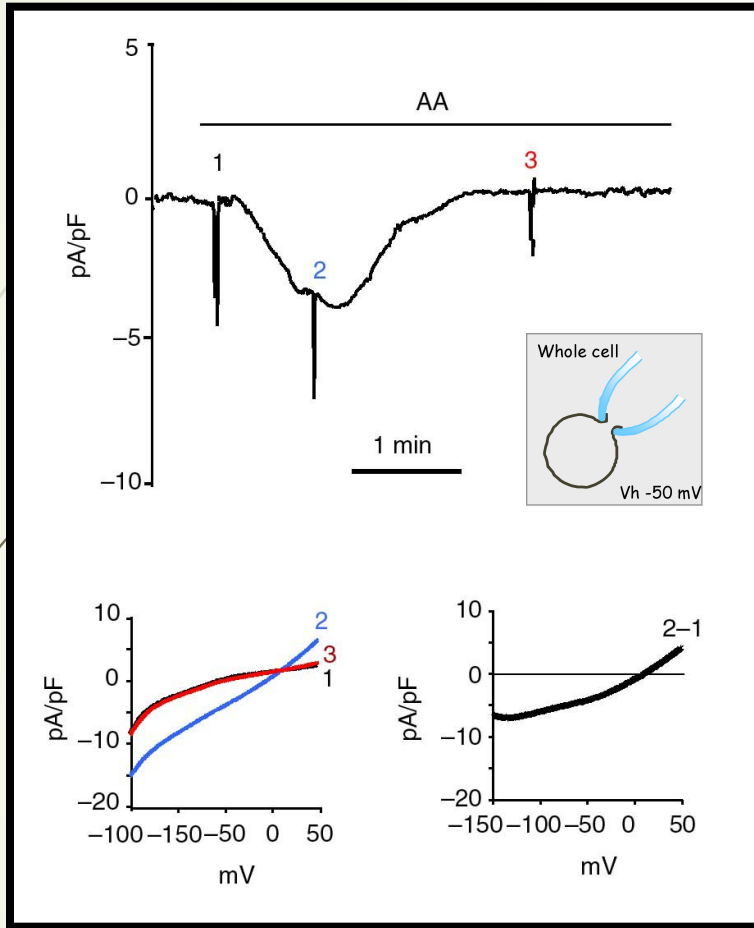

Agonist	E_{rev} (mV)		
	Control	0 Na^+ out	0 Ca^{2+} out
AA	$-5 \pm 17 mV_{(20)}$	$1 \pm 10 mV_{(4)}$	$2 \pm 10_{(4)}$
ETYA	$1 \pm 10 mV_{(6)}$	$8 \pm 11 mV_{(4)}$	$-10 \pm 19_{(4)}$

Fiorio Pla & Munaron, 2001

Single channel analysis revealed that arachidonic acid activates 3 different calcium channels in endothelial cells

Inside out

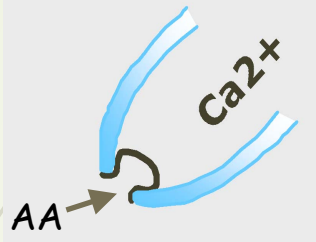

Research

Calcium influx, arachidonic acid, and control of endothelial cell proliferation

A. Fiorio Pla,¹ L. Munaron^{1,2}

¹Department of Animal and Human Biology, University of Torino, Torino, Italy
²INFM, UdR Torino Università, Torino, Italy

